

Appendix 3.7-B

Well Inventory

This page intentionally left blank

Inventory of Wells within 2 Kilometers of the Dewey-Burdock Project Edgemont, South Dakota

June 2012

Prepared by
Powertech (USA) Inc.
P.O. Box 812
Edgemont, South Dakota 57735

Table of Contents

1.0 HISTORICAL RECORDS REVIEWED	4
1.1 Silver King Mines, Inc. Records	4
1.2 Tennessee Valley Authority Records.....	5
1.3 South Dakota Water Well Records.....	6
1.4 South Dakota Oil and Gas Records.....	6
1.5 South Dakota Water Rights Records.....	7
1.6 Wyoming Water Rights Records	7
1.7 Wyoming Oil and Gas Records	7
1.8 RESPEC Records.....	7
1.9 Powertech (USA) Inc. Records.....	8
1.10 Miscellaneous Records.....	8
1.11 Other Records Not Reviewed.....	8
2.0 SUMMARY TABLES	9

List of Tables

- Existing Wells within 2 Kilometers of the Project Area
- Historical Wells Noted in Data Sources within 2 Kilometers but No Longer Present at Surface
- Plugged and Abandoned Wells within 2 Kilometers

List of Appended Source Documents

- WATER WELLS IN EDGEMONT PROJECT AREA
- DRAFT ENVIRONMENTAL STATEMENT FOR EDGEMONT URANIUM MINE TABLE 2.5.2-1
- SOUTH DAKOTA WELL COMPLETION REPORTS
- SOUTH DAKOTA OIL AND GAS RECORDS
- DEWEY BURDOCK GROUNDWATER WELL REPORT 2010 & 2011 FIELD WORK COMPLETED
- RESPEC RESPONSES TO NUCLEAR REGULATORY COMMISSION COMMENTS (REVISION)
- DOMESTIC AND LIVESTOCK WELLS MONITORED DURING FEBRUARY 1982 DEWEY PUMP TEST
- WYOMING WATER RIGHT 183561

- I ADDITIONAL WATER WELLS IN EDGEMONT PROJECT AREA
- J FOREST SERVICE WELLS AND SPRINGS
- K HYDROGEOLOGIC INVESTIGATIONS AT PROPOSED URANIUM MINE NEAR DEWEY, SOUTH DAKOTA
- L COORDINATES, ELEVATIONS AND WATER LEVELS FOR BURDOCK PIEZOMETERS
- M CONSTRUCTION AND LOCATION DATA FOR DEWEY PUMP TEST WELLS
- N BURDOCK MINE AREA HYDROLOGY STATUS REPORT
- O ANALYSIS OF AQUIFER TESTS CONDUCTED AT THE PROPOSED BURDOCK URANIUM MINE SITE
- P HYDRO ID 704 RECOMPLETION
- Q SOUTH DAKOTA WATER RIGHT 380-2
- R AN EARLIER NAME FOR HYDRO ID 710

INVENTORY OF WELLS WITHIN TWO KILOMETERS OF THE DEWEY-BURDOCK PROJECT AREA

Details available for wells constructed within two kilometers of the Dewey-Burdock Uranium Project are provided in this report. Historical records are reviewed in Section 1.0 and summary tables are provided in Section 2.0. Referenced materials are appended and correspond with sources cited in the summary tables.

1.0 HISTORICAL RECORDS REVIEWED

Silver King Mines, Inc. correspondence, Tennessee Valley Authority correspondence and reports, South Dakota and Wyoming databases, RESPEC's RSI 2020 report, Powertech (USA) Inc.'s records, and other records were reviewed to inventory water wells within 2 kilometers of the project in the following sections:

T6S R1E Sections 7 through 10 and 15 through 36

T6S R2E Sections 30, 31 and 32

T7S R1E Sections 1 through 24

T7S R2E Sections 5, 6, 7, 8, 17, 18, and 19

1.1 Silver King Mines, Inc. Records

A letter from Keith Andersen, Silver King Mines, Inc. (SKM), to John Hatch, SD Water Rights Commission, on January 12, 1979 was reviewed. Copies of pump test data and other records from SKM's files were attached, including an interoffice memorandum from Keith Andersen, SKM, to R. Caywood, SKM, dated December 18, 1978. This memorandum provides references to the following information:

- a. Water Wells in the Edgemont Project Area prepared in May 1977: this document shows the location and available information for Hydro IDs 1 through 134; it is provided as Source A
- b. Nine wells installed the Fall of 1976 for measuring water levels during the February 1977 pump test: B-1 FR (#672), B-2 (Abandoned November 1978, no Hydro ID identified), B-3 FR (no Hydro ID identified), B-3 (Abandoned November 1978, no Hydro ID identified), B-4 (Abandoned December 1978, no Hydro ID identified), B-5 (Abandoned December 1978, #637), B-6 FR(#659), B-6 (Abandoned Dec 1978, #660), B8 (#661), and Burdock Well (#668)
- c. Four additional wells installed August 1977 for November 1977 pump test: B-7 FR (#665), B-7 (#666), B-9 FR (#646), and B-9(#658)

- d. Ten wells installed during the Summer of 1978: BPZ 14 (#602), BPZ 15 FR (#601), BPZ 16 (#643), BPZ 17 FR (#644), BPZ 18 (#608), BPZ 19 FR (#607), BPZ 20 (#609), BPZ 21 FR (#610), BPZ 22 (#626), and BPZ 23 FR (#625)
- e. Seven replacement wells installed during the Fall of 1978: B-2 LAK (#674), B-2 FU (#673), B-10 FR (#671), B-10 FU (#670), B-10 LAK (#669), B-11 FR (#664), B-11 LAK (#663)
- f. Test well constructed January 1977 (#668) used during February and November 1977 pump tests

1.2 Tennessee Valley Authority Records

Tennessee Valley Authority's (TVA) Draft Environmental Statement (1979) was reviewed. This document was not finalized. Wells referenced are listed below with corresponding Hydro IDs:

p. 51, test well completed near shaft (#668)

p. 52, map showing following the wells: B-9 (BPZ-9 LAK, #658), B9FR (BPZ-9 FR, #646), B-2 (BPZ-2 LAK, #674), B1FR (BPZ-1 FR, #672), B-7 (BPZ-7 LAK, #666), B7FR (BPZ-7 FR, #665), B-6 (BPZ-6 LAK, #660), B6FR (BPZ-6 FR, #659), B-3 (BPZ-3 LAK, no corresponding Hydro ID), B3FR (BPZ-3 FR, no corresponding Hydro ID), B-4 (BPZ-4 LAK, no corresponding Hydro ID), B-5 (BPZ-5, #637), B-8 (BPZ-8 LAK, #661)

p. 53, 61 water wells within 4 miles are summarized on Table 2.5.2-1 (corresponding Hydro IDs were found for all except D-14, which had no information except a location at SESE 12-7S-1E, and E-7, which also had no information except a location at NENE 6-7S-1E; Source B provides the cross-referenced list)

The TVA report "Analysis of Aquifer Tests Conducted at the Proposed Burdock Uranium Mine Site," WR28-1-520-109, by J.M. Boggs and A.M. Jenkins, May 1980, was reviewed. Wells referenced and corresponding Hydro IDs are: Burdock test well (#668), B-10LAK (#669), B-10FU (#670), B-10FR (#671), B-11LAK (#663), B-11FR (#664), B-9LAK (#658), B-9FR (#646), B-7LAK (#666), B-7FR (#665), and Sundance Well (#662 based on depth but not location).

A letter from Gary Cummings, TVA, to Peter Martin, TVA, on March 23, 1982 regarding water levels at Dewey Pump test monitoring wells was reviewed. Wells referenced and corresponding Hydro IDs are: D-8 (#147), D-6 (#617), D-5 (#616), D-4LK (#622), D-4FR (#623), D-3LK (#657), D-3FR (#436), D-2LK (#612), D-1FU (#614), D-1FR (#613), D-1LK (#615), and Dewey Pumped Well (#611).

A letter from Gary Cummings, TVA, to Peter Martin, TVA, on April 12, 1982 regarding domestic and livestock wells monitored during the Dewey Pump Test was reviewed. Wells referenced are: 119, 103, 104, 39, BPZ 20 FR (#610), BPZ 20 LAK(#609), D-7 (#624), 40U, 40L, 102, 13, 41, 48, BY-1 FR (40U?), BPZ LA 22 (#626), BPZ FR 22 (#625), 99, 96, 106, 107, 115, 147, 148, 38, 49, 109, 110, 111, and 117. Water levels or flow rates are reported. Well locations, construction details and owners are not.

A letter from Gary Cummings, TVA, to Peter Martin, TVA, on July 12, 1982 regarding Dewey observation wells was reviewed. Wells referenced and corresponding Hydro IDs are: Dewey Main Well (#611), D-8 LK (#147), D-5 LK (#616), D-6 LK (#617), D-1 FU (#614), D-1 FR (#613), D-1 LK (#615), D-2 LK (#612), D-3 FR (#436), D-3 LK (#657), D-4 FR (#623), and D-4 LK (#622).

The TVA report "Hydrogeologic Investigations at Proposed Uranium Mine Near Dewey, South Dakota," WR28-2-520-128, by J.M. Boggs, October 1983, was reviewed. Wells referenced and corresponding Hydro IDs are: D-PW (#611), D-1LK (#615), D-1FU (#614), D-1FR (#613), D-2LK (#612), D-3LK (#657), D-3FR (#436), D-4LK (#622), D-4FR (#623), D-5LK (#616), D-6LK (#617), D-7FR (#624), D-8LK (#147), D-20LK (#609), and D-20FR (#610).

A stand-alone table showing well construction and well locations for the Dewey Pump Test wells was reviewed. The wells referenced and corresponding Hydro IDs are: Dewey Test Well (#611), D-1 FR (#613), D-1FU (#614), D-1LK (#615), D-2LK (#612), D-3FR (#436), D-3LK (#657), D-4FR (#623), D-4LK (#622), D-5LK (#616), D-6LK (#617), and D-7FR (#624).

1.3 South Dakota Water Well Records

South Dakota well records were reviewed online. Records were identified for sixty-nine Hydro IDs: 2, 13 recompletion record, 17, 38, BY-1 (possible 40U recompletion), rehabilitation record for 42, 115 replacement record, 147, 220, 429, 431, 432, 433, 436, 510, 609, 610, 611, 612, 613, 614, 615, 616, 617, 622, 623, 624, 631, 657, 662, 663, 664, 668, 669, 670, 671, 673, 674, 676, 677, 678, 679, 680, 681, 682, 683, 684, 685, 686, 687, 688, 689, 690, 691, 692, 693, 694, 695, 696, 697, 698, 703, 704 Unkpapa, 705, 706, 707, 708, 709, and 3026. Seven additional wells with no matching Hydro ID were also identified: SWSW 15-6S-1E Spencer, SWNE 18-6S-1E BNRR, 20-6S-1E SKM, NENE 27-6S-1E Smith, NWNE 29-6S-1E SKM, 2-7S-1E Linch, and 20-7S-1E Tubbs. Assignment of Hydro IDs to these wells is pending ongoing field location and verification work. Records found are provided in Source C.

1.4 South Dakota Oil and Gas Records

South Dakota oil and gas records were reviewed online. Twelve oil tests were identified within two kilometers of the permit boundary. Of these, three had been converted to water wells (API Numbers 4004720045, 4004705093, and 4004720065, which were converted to Hydro IDs 3, 4, and 5, respectively). Of the nine remaining tests, two had no information regarding plugging and abandonment (API Numbers 4003305219 and 400330521 at 19-6S-1E), four were identified as having been plugged and abandoned and a dry hole marker placed at the surface (API Numbers 4004705095 at 2-7S-1E, 4004720071 at 11-7S-1E, 4004705089 at 21-7S-1E, and 40047020077 at 15-7S-1E), two were identified as having been plugged and abandoned with no dry hole marker placed per the landowner's request (API Numbers 4004720085 at 21-7S-1E and 4004720074 at 21-7S-1E), and one (API 4004705147 at 22-7S-1E) was cased to the top of the Spearfish with a cement plug at the base of the casing. The hole is open below the casing to a second cement plug within the 2nd Converse. A steel cap is tack-welded to the surface casing making it available for possible future use as a water-supply well. A dry hole marker was screwed onto the tack-welded cap. Source D provides South Dakota Oil and Gas records for test wells that were not converted to water wells. Completion reports for test wells converted to water wells are provided in Source C.

1.5 South Dakota Water Rights Records

South Dakota water rights were also reviewed online. Three PERMITTED springs (0181-2, 0182-2 and 0183-2) issued to Grand Island and Wyoming Railroad on August 9, 1890 for springs A, B and C in 18-T6S-R1E were identified. One CANCELLED groundwater right was identified for BN Railroad in 19-T6S-R1E. The well associated with this water right was plugged and abandoned on July 31, 1998. A corresponding Hydro ID has not been assigned to it. One LICENSED groundwater right belonging to Henry Hollenbeck, number 380-2, was previously identified by RESPEC and WWC and was confirmed online in NWNW 17-6S-1E. The well associated with this water right still exists and was assigned Hydro ID 710. Coordinates for the well were estimated by Sean Hetrick, Powertech, based on the well's location on a topographic map: East 1019431, North 459018 NAD 1927, South Dakota State Plane South FIPS 4002 (feet). Mark Hollenbeck, Powertech, subsequently measured the coordinates using a handheld GPS February 27, 2012. The well's coordinates converted from the handheld GPS are East 1019432, North 459053 NAD 1927, South Dakota State Plane South FIPS 4002 (feet). The surface elevation from a USGS topographic map at the location of a mapped flowing well is 3,767 feet above mean sea level. Inspection of the well by Mark Hollenbeck the same day indicated the well was no longer flowing and is inaccessible by pump due to the casing being filled to the top with rocks. Subsequent research indicated that Silver King Mines, Inc. was also aware of the presence of this well. A water level taken from it in 1980 was below surface (the well was not flowing). The ID assigned to the well by Silver King Mines, Inc. was 149.

1.6 Wyoming Water Rights Records

Wyoming water rights were reviewed online. Water right 183561 belonging to Putnam and Putnam was previously identified by WWC and confirmed online at SWSW 28-41N-60W. This water right was found to correspond with Hydro ID 5002. Information on the water right was obtained from Ms. Krissie Groth at the Wyoming State Engineer's office in Cheyenne. A second water right, P137.0W for Earl Carr for 2,000 gallons per minute at NENW 21-41N-60W, was identified just outside the 2-kilometer boundary. The status of this water right shows CANCELLED. Further information was not available online, but can be retrieved from the State Engineer's office, if needed.

1.7 Wyoming Oil and Gas Records

Wyoming oil and gas records were reviewed online. No records were identified within the 2-kilometer area reviewed. This is a bit surprising considering the project rests on the eastern boundary of the Powder River Basin. A number of oil tests were identified northwest and southwest of the 2-kilometer boundary.

1.8 RESPEC Records

Logs in Source A-2 of RSI 2020, Draft Characterization of the Groundwater Flow System at the Dewey Burdock Uranium Project, November 2008, were reviewed. State Completion Reports prepared for 25 Powertech wells are not labeled with Hydro IDs. The order is given here for reference: 675, 677, 678, 703, 681, 686, 684, 682, 704, 683, 680, 687, 689, 3026, 698, 688, 690, 692, 696, 694, 685, 691, 693, 697, and 695. These logs are presented again in Appendix 2.2-B of Powertech's 2009 Technical Report.

Of the 56 pages of other State logs presented in Source A-2 of RSI 2020, 33 pages representing 32 logs have matching Hydro IDs, 4 logs have no matching Hydro ID, 4 logs are duplicates, and 15 pages representing 11 logs are outside the two-kilometer area reviewed. Logs are not labeled with Hydro IDs in the Source. The order is given here for reference: 429, 436, 431, 617, 433, 622, 623, dup 623, 657, 432, 614, 613, 609, 610, dup 610, outside 2-km, outside 2-km, outside 2-km, outside 2-km, 663, 664, 669, 670, 671, 674, 673, 662, 11 (2 pages), 220, 115?, outside 2-km, 8, 38, outside 2-km, no match Smith & Associates, outside 2-km (5 pages for same well), outside 2-km, outside-2km, 510, outside 2-km, outside 2-km, no match Tubbs, 2, 17, 13, dup 13, no match Linch, 116, 631, no match Spencer, and dup 662. These logs are presented again in Appendix 2.2-B of Powertech's Technical Report, February 2009.

1.9 Powertech (USA) Inc. Records

Attachments and well construction reports provided in Appendix 2.2-B of the Technical Report, February 2009 were reviewed and found to be the same as those presented by RESPEC in RSI 2020.

TR RAIs submitted to NRC in June 2011 and a report by Mike Beshore prepared in October 2011 were reviewed. Following are notes made regarding wells and Hydro IDs:

- Remove #108 from Table TR RAI P&R 10-1; is outside the 2-kilometer area reviewed
- #116 and #506 appear on both Tables TR RAI P&R 10-1 and 2; revise to show on Table 1 only
- #635 is not a well but a pipeline from #5; move to Table 2
- Add a footnote to #651 indicating it is not a well but a stock tank formerly filled by a pipeline from #6 (Fall River); #6 no longer flows and the stock tank is no longer used
- Wells or former wells possibly within 2 kilometers missing from Tables 1, 2 and 3 are: 50, 710, 5002, B-3, B-3FR, B-4, and APIs 4004705089, 4003305219, 4003305221, 4004705095, 4004705147, 4004720071, 4004720074, 4004720077, 4004720085.

1.10 Miscellaneous Records

A Draft Well Test Analysis report prepared by Dan Hoyer on August 20, 2007 regarding the April 1979 Burdock Lakota Pump Test, the July 1979 Burdock Fall River Pump Test 1982, and the February 1982 Dewey Lakota Pump Test was reviewed. Wells referenced and corresponding Hydro IDs are: BPZ-7FR (#665), BPZ-7LAK (#666), BPZ-11LAK (#663), BPZ-11FR (#664), BPZ-10FU (#670), BPZLAK (#669), PBZ-10FR (#671), Burdock Test Well (#668), PBZ-1FU (#673), PBZ-1FR (#674), BPZ-1FR (#672), BPZ-9FR (#646), PBZ-9LAK (#658), DPZ-7FR (#624), Bud Hollenbeck (#115), DPZ-8LAK (#147), D-3LAK (#657), DPZ-3FR (#436), DPZ 4L dewey 9 (#622), DPZ 4FR dewey 8 (#623), DPZ 2 LK dewey 5 (#612), Dewey Pump Well (#611), DPZ 1 LK dewey 2 (#615), DPZ 6 LK dewey 1 (#617), DPZ 5 LK dewey 10 (#616), 6S1E20AD6 (#613), BPZ 20 FR cement plant east (#610), and BPZ 20 LAK (#609).

1.11 Other Records Not Reviewed

Respec reviewed U.S. Geological Survey (USGS) records while preparing the February 2009 TR. Work prepared by Respec regarding USGS records was not reviewed during this inventory except where Hydro IDs within 2 kilometers occurred.

2.0 SUMMARY TABLES

Wells within two kilometers of the Dewey-Burdock project are summarized in Tables 1, 2 and 3 as follows:

- Table 1 summarizes current wells within two kilometers of the project area. These wells have been physically located in the field.
- Table 2 summarizes historical wells noted in data sources within two kilometers of the project area that are no longer present at the surface. These wells were looked for, but were not found.
- Table 3 summarizes plugged and abandoned wells within two kilometers of the project area. These wells have been confirmed by Powertech (USA) Inc. to be plugged and abandoned. Each well was visually inspected and found to have cement within its casing and/or well bore.

Wells have one of the following uses:

- Domestic: Are currently used or can reasonably be expected to be used for drinking water use, including wells that are also used for livestock water.
- Stock: Water of livestock is sole use; well cannot be used for drinking water use (i.e., no piping to domestic water system, etc.).
- Monitor: Sole use is for monitoring.
- Irrigation: Sole use is for crop irrigation.

Sources referenced in tables are appended.



Table 1. Current Wells within 2 Kilometers of Project Area

Hydro ID	Legal Location				SD State Plane NAD 27		NGVD29	Construction Summary					Flowing Artesian	Aquifer(2)	Use	Other Name	Source
	T.	R.	Sec.	Qtr. Qtr.	East (ft)	North (ft)	Surface Elevation(1) (ft)	Date Completed	Total Depth (ft)	Depth to Top of Screen or Bottom of Casing (ft)	Depth to Bottom of Screen or Bottom of Open Hole (ft)	Casing Diameter (in)					
ALLUVIAL																	
676	6S	1E	34	SESW	1030846	439891	3662	9/26/2007	23	2-inch PVC 0.010-slot 12.5	to 22.5	2-inch PVC 0 to 12.5	no	Alluvial	Monitor	DB-GW676	C
677	7S	1E	4	SWSW	1023527	434077	3562	9/25/2007	14.5	2-inch PVC 0.010-slot 4	to 14	2-inch PVC 0 to 4	no	Alluvial	Monitor	DB-GW677	C
678	7S	1E	9	SWNE	1026522	431925	3595	9/25/2007	14.5	2-inch PVC 0.010-slot 4	to 14	2-inch PVC 0 to 4	no	Alluvial	Monitor	DB-GW678	C
679	6S	1E	27	NWSE	1032294	446245	3715	9/26/2007	39.5	2-inch PVC 0.010-slot 19	to 39	2-inch PVC 0 to 19	no	Alluvial	Monitor	DB-GW679	C
707	6S	1E	34	SWNE	1032064	441813	3693(3)	5/5/2011	40	2-inch PVC 0.010-slot 30	to 40	2-inch Sched 40 PVC 0 to 30	no	Alluvial	Monitor	DB-11-34-ALLUV-4	C
708	7S	1E	3	SESW	1030383	434098	3631(3)	5/4/2011	30	2-inch PVC 0.010-slot 20	to 30	2-inch Sched 40 PVC 0 to 20	no	Alluvial	Monitor	DB-11-3-ALLUV-3	C
709	7S	1E	15	SENW	1029415	426607	3596(3)	5/9/2011	38	2-inch PVC 0.010-slot 28	to 38	2-inch Sched 40 PVC 0 to 28	no	Alluvial	Monitor	DB-11-15-ALLUV-4	C
FALL RIVER																	
5	7S	1E	14	NENW	1035181	427284	3643	12/26/1975	2267, cement bridge plug 850, last measured 175	open hole 155	to 175	28# 8 5/8-inch 0 to 155 and 4-inch steel 0 to 155	yes	Fall River	Stock	D-17, API 40 047 20065	A, B, D, E, downhole tool
6	7S	1E	14	NESE	1037218	425012	3671	Late 1950s	280 original 200 last measured	open hole 135	to 200	12-inch steel 0 to 135	no	Fall River	Stock		A, E
7	7S	1E	23	NWNW	1033304	422417	3574	Late 1950s	200	UNK	UNK	6	no	Fall River	Domestic	D-27, R. Kenobbie	A, B
9	7S	1E	23	NENE	1038003	421806	3594	1960s	90	UNK	UNK	6-inch (Source A) 2-inch steel (Source E)	yes	Fall River	Stock	D-25	A, B, E
14	7S	1E	2	NWSW	1033700	434723	3672	UNK	470 (source A) 300 (source E)	UNK	UNK	4	historically yes, presently no	Fall River	Stock	D-5	A, B, E
17	7S	1E	12	SENW	1040223	431329	3789	1954	156	UNK	UNK	3	no	Fall River	Stock	D-13	A, B, C
18	7S	1E	9	SWSW	1022812	428960	3566	Late 1920s Early 1930s	527	UNK	UNK	4	yes	Fall River	Domestic	D-10, D. Andersen	A, B, E
37	7S	2E	18	NWSW	1044183	423947	3689	UNK	145	open hole 93	to 145	5 1/2-inch 0 to 93	no	Fall River	Stock		A, E, downhole tool
38	6S	1E	33	SWNW	1024328	442289	3634	11/12/1949	550	open hole 494	to 550	4-inch 0 to 494	yes	Fall River	Stock	B-4	A, B, C, F
49	6S	1E	32	NWNW	1018932	444022	3628	1970s	540 (historically 600)	screen 475	to 540	4	yes	Fall River	Stock		A, E
107	6S	1E	18	SWNE	1017018	458158	3708	UNK	90	UNK	UNK	5	historically yes, presently unknown	Fall River	Domestic		A
111	6S	1E	17	NWNE	1022074	459586	3794	UNK	100	UNK	UNK	4	no	Fall River	Stock		A
112	6S	1E	16	SESE	1027864	455881	3831	UNK	120	UNK	UNK	4 1/2	no	Fall River	Stock		A
116	6S	1E	18	SENE	1017992	458111	3723	UNK	UNK	UNK	UNK	1	historically yes, presently unknown	Fall River	Stock		A
138	6S	1E	18	NENE	1017537	459030	3724	1977	100	UNK	UNK	UNK	historically yes, presently unknown	Fall River	Domestic		I
436	6S	1E	20	NWNE	1021603	454436	3737	8/18/1981	590	open hole 505	to 590	4-inch 10#/ft black iron 0 to 505	no	Fall River	Monitor	D-3FR	C, K, M
610	6S	1E	29	SWNE	1021599	447969	3704	6/27/1978	680	1-inch 40# black iron torch slotted 630	to 672	1-inch 40#/ft black iron 0 to 630	no	Fall River	Monitor	D-20FR, BPZ-21 FR	C, K, L
613	6S	1E	20	NWNE	1022125	453775	3738	8/14/1981	580, lithologic log to 600	open hole 504	to 580	4-inch 10#/ft black iron 0 to 504	no	Fall River	Monitor	D-1FR	C, K, M
623	6S	1E	20	NENE	1022669	454299	3750	8/17/1981	580	open hole 503	to 580	4-inch 10#/ft black iron 0 to 503	no	Fall River	Monitor	D-4FR	C, E, K, M
624	6S	1E	18	SENE	1017992(4)	458111(4)	3723(4)	7/30/1981	120	4-inch slotted PVC casing 90	to 115	4-inch 160# PVC 0 to 90	historically yes, presently unknown	Fall River	Monitor	D-7FR	C, K, M

Table 1. Current Wells within 2 Kilometers of Project Area

Hydro ID	Legal Location				SD State Plane NAD 27		NGVD29	Date Completed	Total Depth (ft)	Construction Summary			Flowing Artesian	Aquifer(2)	Use	Other Name	Source
	T.	R.	Sec.	Qtr. Qtr.	East (ft)	North (ft)	Surface Elevation(1) (ft)			Depth to Top of Screen or Bottom of Casing (ft)	Depth to Bottom of Screen or Bottom of Open Hole (ft)	Casing Diameter (in)					
628	6S	1E	20	SESE	1022654	449402	3737	UNK	523	326	523	UNK	no	Fall River	Stock		GPS, downhole tool
631	6S	1E	26	NWNW	1034335	448992	3744	2/1998	80	5-inch steel 1/4 x 6 slots 30	to 70	5-inch 15.5#/ft steel 0 to 30	no	Fall River	Stock		C
638	7S	1E	2	NENE	1038269	437976	3791	Before 1979	180	UNK	UNK	2	no	Fall River	Monitor	D-2	B
681	6S	1E	32	NENW	1020330	443725	3624	1/27/2008	600	3-inch PVC 0.020-slot 585	to 600	6-inch SDR21 0 to 585 3-inch PVC 575 to 585	yes	Fall River	Monitor	DB07-32-3C	C
683	6S	1E	29	NESW	1020209	446107	3669	3/4/2008	650	2-inch PVC 0.020-slot 635	to 650	4-inch SDR17 0 to 635 2-inch PVC 625 to 635	no	Fall River	Monitor	DB07-29-7	C
685	6S	1E	32	NWNE	1020687	443415	3626	2/4/2008	595	2-inch PVC 0.020-slot 580	to 595	4-inch SDR17 0 to 580 2-inch PVC 570 to 580	yes	Fall River	Monitor	DB07-32-4C	C
687	6S	1E	32	NENW	1020078	443730	3626	2/6/2008	605	2-inch PVC 0.020-slot 590	to 605	4-inch SDR17 0 to 590 2-inch PVC 580 to 590	yes	Fall River	Monitor	DB07-32-5	C
688	7S	1E	11	NESW	1035027	429974	3687	4/1/2008	255	3-inch PVC 0.020-slot 245	to 255	6-inch SDR17 0 to 245 3-inch PVC 235 to 245	no	Fall River	Monitor	DB08-11-17	C
691	6S	1E	32	NENW	1020366	443706	3626	3/10/2008	505	3-inch PVC 0.020-slot 490	to 505	6-inch SDR17 0 to 490 3-inch PVC 480 to 490	yes	Fall River	Monitor	DB08-32-9C	C
694	7S	1E	15	NWNW	1028717	426836	3600	3/22/2008	392	3-inch PVC 0.020-slot 377	to 392	6-inch SDR17 0 to 377 3-inch PVC 367 to 377	yes	Fall River	Monitor	DB08-15-3	C
695	6S	1E	32	SESE	1022385	439312	3594	3/20/2008	508	3-inch PVC 0.020-slot 493	to 508	6-inch SDR17 0 to 493 3-inch PVC 483 to 493	yes	Fall River	Monitor	DB08-32-13	C
698	7S	1E	2	NESW	1035946	436967	3739	3/25/2008	205	3-inch PVC 0.020-slot 180	to 205	6-inch SDR21 0 to 180 3-inch PVC 170 to 180	no	Fall River	Monitor	DB08-2-1	C
706	6S	1E	21	NENE	1028589	453276	3823.29(5)	12/5/2009	328	3-inch PVC 0.020-slot 284	to 314	6-inch SDR17 0 to 284 3-inch PVC 274 to 284	no	Fall River	Monitor	DB09-21-2	C
FUSON																	
614	6S	1E	20	NWNE	1022185	453769	3739	9/14/1981	620	open hole 609	to 620	4-inch 10#/ft black iron 0 to 609	no	Fuson	Monitor	D-1FU	C, K, M
CHILSON																	
1	7S	1E	9	SESE	1027696	429227	3624	1950s	600	UNK	UNK	4	yes	Chilson	Stock	D-11	A, B
2	7S	1E	16	SESE	1026724	423922	3554	1930s Recompleted 11/17/1981	640 original 650 recompleted	4-inch slotted 10#/ft black iron 566 to 608	and 629 to 650	4-inch 10#/ft black iron 0 to 566 and 608 to 629	yes	Chilson	Domestic	D-20, W. Peterson	A, B, C
3	7S	1E	22	SWNW	1028593	421104	3541	11/28/1970	2400, cement bridge plug 1030	open hole 367	to 1030	4 1/2-inch steel 0 to 389 suspended inside 8 5/8-inch 20# steel 0 to 367	yes	Chilson	Stock	D-24, API 40 047 20045	A, B, D
12	7S	1E	4	SESE	1026978	434378	3641	Late 1960s	730 (source A) 805 (source B)	UNK	UNK	4 1/2	yes	Chilson	Stock	D-7	A, B
13	7S	1E	3	NWNW	1028360	438470	3673	1950s Recompleted 10/22/1980	625	open hole 580	to 625	5 1/2-inch 14# steel 0 to 580	yes	Chilson	Domestic	D-6, K. Spencer	A, B, C
15	7S	1E	2	NENW	1035304	438317	3713	UNK	280 (source A) 495 (source B)	UNK	UNK	4	no	Chilson	Stock	D-3	A, B, E
16	7S	1E	1	NWSE	1041428	434446	3869	Mid 1970s	330	UNK	UNK	4 1/2	no	Chilson	Domestic	D-1, C. Daniel	A, B
42	7S	1E	5	SWNE	1021144	436481	3596	1949 Rehabilitated 11/15/2009	Original 600 Current 580	4-inch PVC 0.25-slot 280	to 300 with open hole below to 580	4-inch steel 0 to 280 8-inch steel 0 to 220 reduced to 1 1/4-inch at surface	yes	Chilson	Domestic	D-8, L. Putnam	A, B, C
43	6S	1E	34	SWSE	1031123	439436	3672	UNK	350	UNK	UNK	4	historically yes until Triangle Mine dewatered then no, presently unknown	Chilson	Domestic	B-5, Spencer Homestead	A, B
50	41N	60W	28	SWNW	974693	446835	3677	1930s	609	UNK	UNK	4	yes	Chilson	Stock	50N	A
51	7S	1E	9	SENE	1027411	431487	3615	1890s	550	UNK	UNK	10	yes	Chilson	Stock	D-9	A, B
61	7S	1E	11	NWSE	1036832	429987	3740	UNK	525	UNK	UNK	5	no	Chilson	Stock	D-12	A, B
96	41N	60W	22	SWSW	1011630	451853	3664	UNK	560	UNK	UNK	5	yes	Chilson	Domestic	Dixon	A
102	6S	1E	18	SWNE	1016825	458312	3708	UNK	267	UNK	UNK	5	yes	Chilson	Domestic		A

Table 1. Current Wells within 2 Kilometers of Project Area

Hydro ID	Legal Location				SD State Plane NAD 27		NGVD29	Date Completed	Total Depth (ft)	Construction Summary			Flowing Artesian	Aquifer(2)	Use	Other Name	Source
	T.	R.	Sec.	Qtr. Qtr.	East (ft)	North (ft)	Surface Elevation(1) (ft)			Depth to Top of Screen or Bottom of Casing (ft)	Depth to Bottom of Screen or Bottom of Open Hole (ft)	Casing Diameter (in)					
109	6S	1E	17	NENW	1020801	459625	3835	UNK	220	UNK	UNK	UNK	no	Chilson	Domestic	Cook	A
110	6S	1E	17	NENE	1023777	459643	3817	UNK	240	UNK	UNK	6 1/2	no	Chilson	Stock		A
147	6S	1E	17	NESW	1020879	456566	3729	2/9/1982	750	open hole 650	to 750	4 1/2-inch 0.219-wall steel 0 to 650	no	Chilson	Monitor	D-8LK, HAM-4	C, K
510	7S	1E	12	SESE	1042933	428178	3759	6/12/1988	540	5-inch PVC 0.064-slot 300 to 340	and 480 to 520	5-inch PVC 0 to 300 and 340 to 480	yes	Chilson	Stock		C
609	6S	1E	29	SWNE	1021735	447808	3702	6/26/1978	1000	1-inch 40# black iron torch slotted 903	to 966	1-inch 40#/ft black iron 0 to 903	no	Chilson	Monitor	D-20LK, BPZ-20	C, K, L
611	6S	1E	20	NWNE	1021837	453958	3731	10/17/1981	815	8 5/8-inch 0.030-slot galvanized steel 695 to 730	and 755 to 800	20-inch steel 0 to 25 10 3/4-inch steel 0 to 695 8 5/8-inch steel 730 to 755	no	Chilson	Monitor	D-PW	C, K, M
612	6S	1E	20	NWNE	1021757	454133	3732	8/14/1981	800	open hole 692	to 800	4-inch 10#/ft black iron 0 to 692	no	Chilson	Monitor	D-2LK	C, K, M
615	6S	1E	20	NWNE	1022172	453708	3738	8/13/1981	800	open hole 712	to 800	4-inch 10#/ft black iron 0 to 712	no	Chilson	Monitor	D-1LK	C, K, M, downhole tool
616	6S	1E	20	SWNE	1022135	453141	3745	9/15/1981	835	open hole 735	to 835	4-inch 10#/ft black iron 0 to 735	no	Chilson	Monitor	D-5LK	C, K, M
617	6S	1E	20	NWNE	1021029	453586	3723	9/15/1981	810	open hole 715	to 810	4-inch 10#/ft black iron 0 to 715	no	Chilson	Monitor	D-6LK	C, K, M
619	7S	1E	2	NWNW	1034739	437071	3701	UNK	286	231	286	4	no	Chilson	Stock	D-4, Daniel West, MET	B, downhole tool
620	6S	1E	35	NWNW	1033951	443209	3731	UNK	UNK	UNK	UNK	UNK	no	Chilson	Stock		GPS
622	6S	1E	20	NENE	1022776	454033	3747	8/17/1981	780	open hole 714	to 780	4-inch 10#/ft black iron 0 to 714	no	Chilson	Monitor	D-4LK	C, E, K, M
637	7S	1E	11	NESE	1038075	430320	3743	Fall 1976	UNK	UNK	UNK	2	no	Chilson	Monitor	BPZ-5	L, N
650	7S	1E	1	SESE	1043795	433351	3820	UNK	196	146	196	4	no	Chilson	Stock		GPS, downhole tool
657	6S	1E	20	NWNE	1021637	454497	3740	8/18/1981	800	open hole 715	to 800	4-inch 10#/ft black iron 0 to 715	no	Chilson	Monitor	D-3LK	C, K, M
680	7S	1E	11	NESW	1035078	429969	3688	12/19/2007	436	4.5-inch PVC 0.020-slot 426	to 436	6-inch SDR21 0 to 426 4.5-inch PVC 406 to 426	no	Chilson	Monitor	DB07-11-11C	C
682	7S	1E	11	SENW	1035136	431259	3720	2/21/2008	460	2-inch PVC 0.020-slot 450	to 460	4-inch SDR17 0 to 450 2-inch PVC 440 to 450	no	Chilson	Monitor	DB07-11-2	C
684	7S	1E	11	NESW	1035188	429745	3691	2/13/2008	423	2-inch PVC 0.020-slot 413	to 423	4-inch SDR17 0 to 413 2-inch PVC 403 to 413	no	Chilson	Monitor	DB07-11-14C	C
686	7S	1E	11	NESW	1034966	429751	3694	2/24/2008	428	2-inch PVC 0.020-slot 418	to 428	4-inch SDR17 0 to 418 2-inch PVC 408 to 418	no	Chilson	Monitor	DB07-11-15	C
689	6S	1E	32	NENW	1020316	443789	3626	3/11/2008	730	3-inch PVC 0.020-slot 715	to 730	6-inch SDR17 0 to 715 3-inch PVC 705 to 715	yes	Chilson	Monitor	DB08-32-10	C
692	7S	1E	11	NESW	1035068	429999	3701	4/16/2008	335	3-inch PVC 0.020-slot 325	to 335	6-inch SDR17 0 to 325 3-inch PVC 315 to 325	no	Chilson	Monitor	DB08-11-19	C
696	7S	1E	15	NWNW	1028687	426946	3602	3/21/2008	587	3-inch PVC 0.020-slot 572	to 587	6-inch SDR17 0 to 572 3-inch PVC 562 to 572	yes	Chilson	Monitor	DB08-15-2	C
697	6S	1E	32	SESE	1022350	439347	3594	3/18/2008	682	3-inch PVC 0.020-slot 667	to 682	6-inch SDR17 0 to 667 3-inch PVC 657 to 667	yes	Chilson	Monitor	DB08-32-12	C
704(6)	7S	1E	5	SWNE	1020966	436647	3599	Original 4/29/2008 Perforated 2/4/2009	UNK	UNK	UNK	UNK	UNK	Chilson (Beginning 2/4/2009)	Domestic	L. Putnam 704 Unkpapa	P



Table 1. Current Wells within 2 Kilometers of Project Area

Hydro ID	Legal Location				SD State Plane NAD 27		NGVD29	Construction Summary					Flowing Artesian	Aquifer(2)	Use	Other Name	Source
	T.	R.	Sec.	Qtr. Qtr.	East (ft)	North (ft)	Surface Elevation(1) (ft)	Date Completed	Total Depth (ft)	Depth to Top of Screen or Bottom of Casing (ft)	Depth to Bottom of Screen or Bottom of Open Hole (ft)	Casing Diameter (in)					
705	6S	1E	21	NENE	1028624	453314	3825.53(5)	12/5/2009	Borehole TD 600 Cemented to 460	3-inch PVC 0.020-slot 428	to 458	6-inch SDR17 0 to 428 3-inch PVC 418 to 428	no	Chilson	Monitor	DB09-21-1	C
3026	7S	1E	1	SESE	1043749	433354	3822	3/26/2008	196	3-inch PVC 0.020-slot 166	to 196	6-inch SDR21 0 to 166 3-inch PVC 156 to 166	no	Chilson	Monitor	DB08-1-6	C
5002	41N	60W	28	SWSW	974687	446660	3681	1970s	639	UNK	UNK	6	yes	Chilson	Stock	WR P183561	A, H
7002	7S	1E	23	NWNW	1033333	421931	3571	1930s	500	UNK	UNK	5 1/2	yes	Chilson	Stock	D-26	A, B
INYAN KARA																	
40(7)	6S	1E	30	SWNW	1013415	447182	3635	About 1969	660 (680 for BY-1)	UNK	UNK	6	yes	Inyan Kara	Domestic	40S, 40U possibly BY-1	A, G C for BY-1
115	6S	1E	18	SENE	1017697	457640	3720	Original before 1977 Replaced 10/2/1984	360	4-inch PVC 1/64-slot 200 to 220	and 300 to 360	6-inch yellow mine 0 to 180 4-inch PVC 160 to 200 4-inch PVC 220 to 300	yes	Inyan Kara	Domestic		A, C
668	7S	1E	15	NWNE	1031029	427450	3622	1/31/1977	574	10-inch stainless steel 280 to 335 (300 to 350 source E)	and 8-inch stainless steel 480 to 555 (495 to 550 source E)	10-inch steel 0 to 280 (0 to 300 source E) and 335 to 480 (350 to 495 source E)	yes	Inyan Kara	Stock	Burdock Well	C, E, L, O
4002	6S	1E	30	NWSW	1013414	446931	3621	1940s	700	UNK	UNK	6	yes	Inyan Kara	Domestic	40L	A, G
SUNDANCE																	
662	7S	1E	11	SESW	1035381	428928	3679	7/26/1978	880	5 1/2-inch 14# torch slotted 666	to 780	5 1/2-inch 14# steel 0 to 666	yes	Sundance	Monitor	Sundance Well	C, L, O
UNKPAPA																	
114	7S	2E	7	SESW	1045410	428653	3764	UNK	365	UNK	UNK	UNK	no	Unkpapa	Stock	E-2, Bennett Canyon Well	A, B, J
506	7S	2E	8	SWNW	1050129	430704	3936	UNK	470	UNK	UNK	UNK	no	Unkpapa	Stock	E-3	B
690	7S	1E	11	NESW	1035113	429971	3700	4/15/2008	631	3-inch PVC 0.020-slot 621	to 631	6-inch 18# 0 to 621 3-inch PVC 611 to 621	yes	Unkpapa	Monitor	DB08-11-18	C
693	6S	1E	32	NENW	1020329	443667	3626	3/8/2008	930	3-inch PVC 0.020-slot 910	to 930	6-inch 18# 0 to 910 3-inch PVC 890 to 910	yes	Unkpapa	Monitor	DB08-32-11	C
703	7S	1E	1	SWSE	1042294	434136	3877	4/18/2008	525	3-inch PVC 0.020-slot 475	to 525	6-inch 18# 0 to 475 3-inch PVC 465 to 475	no	Unkpapa	Domestic	C. Daniel DB08-1-7	C
704(6)	7S	1E	5	SWNE	1020966	436647	3599	4/29/2008	955	3-inch PVC 0.020-slot 915	to 955	6-inch 18# 0 to 915 3-inch PVC 905 to 915	yes	Unkpapa (Cemented to Chilson 1/28/2009)	Domestic	L. Putnam DB08-5-1	C
UNKNOWN																	
4	7S	1E	15	SESE	1032516	423080	3580	3/5/1965	2264, cement bridge plug 1645	open hole 971	to 1645	24# 8 5/8-inch 0 to 971 reduced to 3-inch at surface	yes	Unknown	Stock	D-19, API 40 047 05093	A, B, D
41	6S	1E	31	SWNE	1015385	442081	3611	UNK	UNK	UNK	UNK	6	yes	Unknown	Stock	B-3	A, B, G
106	6S	1E	18	NENE	1018099	459625	3724	UNK	196	open hole 160	to 196	7-inch steel 0 to 160	yes	Unknown	Stock		A, E, downhole tool
113	7S	2E	6	NESW	1046437	434417	3844	UNK	40	UNK	UNK	UNK	no	Unknown	Stock	E-1, Bennett #2 Well	A, B, J
117	6S	1E	8	SWSE	1022177	460796	3923	UNK	UNK	UNK	UNK	6	No	Unknown	Stock		A
220	6S	1E	19	SENE	1017872	452334	3680	10/16/1984	900	historically 4-inch slotted PVC 780 to 800 and 840 to 880	presently 6-inch PVC screen 463 to 523, caved below	historically 6" yellow mine 0-520 and 4" PVC 500-780, 800-840 & 880-900, presently 6" PVC 0-463	yes	Unknown	Stock		C, E
270	6S	1E	19	NWSW	1014108	451942	3659	UNK	UNK	UNK	UNK	2-inch steel	yes	Unknown	Stock		GPS, E
618	7S	1E	2	SENE	1038074	435906	3759	UNK	133	62	133	5	no	Unknown	Stock		GPS, downhole tool
639	7S	2E	7	SENW	1045704	430722	3771	UNK	UNK	UNK	UNK	UNK	no	Unknown	Stock		GPS
640	7S	1E	12	SESE	1043010	427965	3754	UNK	UNK	UNK	UNK	1	no	Unknown	Stock		GPS
642	7S	1E	12	SESE	1042926	428042	3757	UNK	33	open hole 12	to 33	5-inch steel 0 to 12	no	Unknown	Stock		GPS, E, downhole tool
645	7S	1E	16	NENE	1027681	427998	3609	UNK	UNK	UNK	UNK	UNK	no	Unknown	Stock		GPS

Table 1. Current Wells within 2 Kilometers of Project Area

Hydro ID	Legal Location				SD State Plane NAD 27		NGVD29	Construction Summary					Flowing Artesian	Aquifer(2)	Use	Other Name	Source
	T.	R.	Sec.	Qtr. Qtr.	East (ft)	North (ft)	Surface Elevation(1) (ft)	Date Completed	Total Depth (ft)	Depth to Top of Screen or Bottom of Casing (ft)	Depth to Bottom of Screen or Bottom of Open Hole (ft)	Casing Diameter (in)					
656	6S	1E	31	SENW	1014230	442000	3622	UNK	UNK	UNK	UNK	UNK	yes	Unknown	Stock		GPS
710	6S	1E	17	NWNW	1019432(8)	459053(8)	3767(9)	Before 6/29/1951	376	UNK	UNK	UNK	historically yes, presently no	Unknown	Irrigation	WR 380-Z, 149	Q, R

Notes: (1) Surface elevations are based on a digital elevation model (DEM), except where noted. Accuracy is plus or minus 15 feet.
 (2) Inyan Kara indicates screened interval is across Fall River and Chilson.
 (3) Estimated from Powertech digital topographic map
 (4) Coordinates and elevation for Hydro ID 116 used for Hydro ID 624 pending field verification
 (5) Surveyed by Andersen Engineers, March 2011
 (6) 704 was originally completed in the Unkpapa aquifer. It was recompleted 1/28/2009 in the Chilson aquifer.
 (7) Hydro ID 40 possibly replaced by BY-1 (depth 680 ft and casing diameter 5.5 inches) on 3/4/1982
 (8) Handheld GPS coordinates converted to South Dakota State Plane NAD 27, Powertech (USA) Inc., February 2012
 (9) USGS 7.5 Minute Series (Topographic), Dewey Quadrangle, Wyoming-South Dakota, 1951
 UNK = Unknown

Sources: A. Water Wells in Edgemont Project Area, Silver King Mines, May 1977, in letter from Keith Andersen, Silver King Mines, Inc., to John Hatch, South Dakota Water Rights Commission, January 12, 1979
 B. Tennessee Valley Authority Draft Environmental Statement, 1979, Table 2.5.2-1
 C. South Dakota Water Well Records - Notice of Well Construction Records, Artesian Well Repair Records, and Well Drillers Reports
 D. South Dakota Oil and Gas Records
 E. Dewey Burdock Groundwater Well Report for 2010 and 2011 Field Work Completed, M. Beshore, Powertech (USA) Inc., October 4, 2011
 F. Responses to Nuclear Regulatory Commission Comments (Revision 1), C. Hocking, RESPEC, to M. Hollenbeck, Powertech (USA) Inc., July 22, 2010
 G. Letter from SKM to TVA, Domestic and Livestock Wells Monitored During Dewey Pump Test, April 12, 1982
 H. Wyoming Water Right Permit 183561, June 12, 2007
 I. Additional Water Wells in Edgemont Project Area, Silver King Mines, Inc., Interoffice Correspondence, Andersen to Caywood, August 3, 1979
 J. Forest Service Wells and Springs, in letter from Keith Andersen, Silver King Mines, Inc., to John Hatch, South Dakota Water Rights Commission, January 12, 1979
 K. Hydrogeologic Investigations at Proposed Uranium Mine Near Dewey, South Dakota, Tennessee Valley Authority, WR28-2-520-128, J. Mark Boggs, October 1983
 L. Coordinates, Elevations and Water Levels for Burdock Piezometers, in letter from Keith Andersen, Silver King Mines, Inc., to John Hatch, South Dakota Water Rights Commission, January 12, 1979
 M. Baseline Water Quality and Water Level/Flow Rates, in letter from Keith Andersen, Silver King Mines, Inc., to Steve Stampfli, Office of Surface Mining, South Dakota Department of Water and Natural Resources, March 3, 1982
 N. Burdock Mine Area Hydrology Status Report, Silver King Mines, Inc. Interoffice Correspondence from Keith Andersen to R.M. Caywood, December 18, 1978, included in letter from Keith Andersen to John Hatch, South Dakota Water Rights Commission, January 12, 1979
 O. Analysis of Aquifer Tests conducted at the Proposed Burdock Uranium Mine Site, Burdock, South Dakota, Tennessee Valley Authority, WR28-1-520-109, J.M. Boggs and A.M. Jenkins, May 1980
 P. Interoffice communication, Len Eakin, Powertech (USA) Inc., to Mike Beshore, Powertech (USA) Inc., May 9, 2011
 Q. South Dakota Water Right 380-2
 R. Letter from R.M. Caywood, Silver King Mines, Inc., to Clinton C. Smythe, Tennessee Valley Authority, regarding addition of Well No. 149 to monitoring program, May 12, 1980

Table 2. Historical Wells Noted in Data Sources within 2 Kilometers but No Longer Present at Surface

Hydro ID	Legal Location				SD State Plane NAD 27		NGVD29	Construction Summary					Flowing Artesian	Former Aquifer	Previous Use	Other Name	Source
	T.	R.	Sec.	Qtr. Qtr.	East (ft)	North (ft)	Surface Elevation(1) (ft)	Date Completed	Total Depth (ft)	Depth to Top Screen (ft)	Depth to Bottom Screen (ft)	Casing Diameter (in)					
ALLUVIAL																	
502	6S	1E	27	NWSE	1031990	446360	3716	UNK	46	UNK	UNK	UNK	no	Alluvial	Unknown	B-2	B
621	6S	1E	27	NWSE	1031930	446397	3717	UNK	50	UNK	UNK	UNK	no	Alluvial	Unknown	B-1	B
FALL RIVER																	
646	7S	1E	15	SWNE	1031248	426409	3611	August 1977	293	251	293	1	yes	Fall River	Monitor	B-9FR	L, N, O
659	7S	1E	10	SWNE	1031876	431048	3651	Fall 1976	UNK	UNK	UNK	UNK	yes	Fall River	Monitor	B-6FR	O
664	7S	1E	10	SWSE	1030634	428338	3621	11/7/1978	360	315	360	4.5	yes	Fall River	Monitor	B-11FR	C, L, O
671	7S	1E	15	NWNE	1031016	427870	3623	10/18/1978	350	300	350	4.5	yes	Fall River	Monitor	B-10FR	C, L, O
672	7S	1E	15	NWNE	1030632	427480	3622	Fall 1976	376	334	376	4	yes	Fall River	Monitor	B-1FR	L, O
CHILSON																	
10	7S	1E	13	NENE	1043664	427041	3736	1970s	200	UNK	UNK	UNK	no	Chilson	Stock	D-15	A, B
39	6S	1E	29	NENE	1022916	448656	3733	UNK	700	UNK	UNK	5	no	Chilson	Stock		A
48	6S	1E	19	SENW	1015295	453037	3663	Late 1960s	725	UNK	UNK	2 1/2	yes	Chilson	Stock		A
425	7S	1E	14	SENW	1034449	426208	3630	UNK	237	UNK	UNK	UNK	UNK	Chilson	Unknown		USGS
658	7S	1E	15	SWNE	1031234	426398	3611	August 1977	545	503	545	1	yes	Chilson	Monitor	B-9LAK	L, N, O
660	7S	1E	10	SWNE	1031822	431030	3652	Fall 1976	UNK	UNK	UNK	UNK	yes	Chilson	Monitor	B-6	O
661	7S	1E	12	NENW	1040977	431970	3694	Fall 1976	UNK	UNK	UNK	UNK	no	Chilson	Monitor	B-8	O
663	7S	1E	10	SWSE	1030659	428346	3621	11/7/1978	550	504	550	4.5	yes	Chilson	Monitor	B-11LAK	C, L, O
669	7S	1E	15	NWNE	1031005	427910	3622	10/25/1978	550	510	550	4.5	yes	Chilson	Monitor	B-10LAK	C, L, O
674	7S	1E	15	NWNE	1030555	427513	3621	11/6/1978	570	525	570	4.5	yes	Chilson	Monitor	B-2LAK	C, L, O
670	7S	1E	15	NWNE	1031065	427936	3623	10/19/1978	395	377	395	4.5	yes	Fuson	Monitor	B-10FU	C, L, O
673	7S	1E	15	NWNE	1030628	427511	3622	11/6/1978	420	400	420	4.5	no	Fuson	Monitor	B-1FU, B-2FU	C, L, O
UNKNOWN																	
634	6S	1E	34	NESE	1032502	440168	3689	UNK	UNK	UNK	UNK	UNK	no	Unknown	Unknown		GPS
OTHER																	
429	6S	1E	20	SENE	1023157	452953	3783	NA	800	NA	NA	NA	NA	Not a Well	NA		USGS, duplicates 615
431	6S	1E	20	SENE	1023157	452953	3783	NA	815	NA	NA	NA	NA	Not a Well	NA		USGS, duplicates 611
433	6S	1E	20	SENE	1023157	452953	3783	NA	835	NA	NA	NA	NA	Not a Well	NA		USGS, duplicates 616
432	6S	1E	20	SENE	1023157	452953	3783	NA	800	NA	NA	NA	NA	Not a Well	NA		USGS, duplicate 612
605(2)	7S	1E	10	SWSE	1031814	428484	3642	NA	NA	NA	NA	NA	NA	Not a Well(2)	NA		E
635(3)	7S	1E	14	NENW	1004085	427131	3643	NA	NA	NA	NA	NA	NA	Not a Well(3)	NA		E
651(4)	7S	1E	14	NWSE	1036009	424246	3600	NA	NA	NA	NA	NA	NA	Not a Well(4)	NA		E

Notes: (1) Surface elevations are based on a digital elevation model (DEM), except where noted. Accuracy is plus or minus 15 feet.
 (2) Hydro ID 605 is not a well. It is a pipe from Hydro ID 668.
 (3) Hydro ID 635 is not a well. It is a pipe from 5.
 (4) Hydro ID 651 is not a well. It was historically a pipe from Hydro ID 6.
 UNK = Unknown
 NA = Not applicable, not a well

Table 3. Plugged and Abandoned Wells within 2 Kilometers of the Project Area

Hydro ID	Legal Location				SD State Plane NAD 27		NGVD29	Construction Summary					Flowing Artesian	Former Aquifer	Previous Use	Other Name	Source
	T.	R.	Sec.	Qtr. Qtr.	East (ft)	North (ft)	Surface Elevation(1) (ft)	Date Completed	Total Depth (ft)	Depth to Top Screen (ft)	Depth to Bottom Screen (ft)	Casing Diameter (in)					
FALL RIVER																	
665	7S	1E	11	SWSW	1033153	428901	3672	August 1977	252	210	252	1	no	Fall River	Monitor	B-7FR	L, N, O
---	6S	1E	19	SWSE	Long 104.042397	Lat 43.508820	3690	1/1/1931	405	0	0	UNK		Fall River	Oil Test	API 40 033 05219	D
---	6S	1E	19	SWSE	Long 104.042397	Lat 43.508820	3690	1/1/1932	420	0	0	UNK		Fall River	Oil Test	API 40 033 05221	D
CHILSON																	
666	7S	1E	11	SWSW	1033128	428870	3669	August 1977	441	399	441	1	no	Chilson	Monitor	B-7LAK	L, N, O
MINNELUSA																	
---	7S	1E	2	SESE	Long 103.958032	Lat 43.466062	3792	8/19/1964	2447	0	0	8 5/8-inch 0 to 142		Minnelusa	Oil Test	API 40 047 05095	D
---	7S	1E	22	NWSE	Long 103.983142	Lat 43.429674	3522	12/24/1965	2400	0	0	14-inch 0 to 30 8 5/8-inch 0 to 1125		Minnelusa	Oil Test	API 40 047 05147	D
---	7S	1E	11	SWSE	Long 103.963826	Lat 43.451453	3679	12/22/1976	2250	0	0	8 5/8-inch 0 to 163		Minnelusa	Oil Test	API 40 047 20071	D
---	7S	1E	21	NENE	Long 103.997735	Lat 43.433117	3533	4/7/1979	2500	0	0	8 5/8-inch 0 to 250		Minnelusa	Oil Test	API 40 047 20074	D
---	7S	1E	15	SWSW	Long 103.991563	Lat 43.435870	3564	8/13/1979	2462	0	0	8 5/8-inch 0 to 660		Minnelusa	Oil Test	API 40 047 20077	D
---	7S	1E	21	NENE	Long 103.996978	Lat 43.433064	3537	1/24/1980	2460	0	0	8 5/8-inch 0 to 800		Minnelusa	Oil Test	API 40 047 20085	D
MADISON																	
---	7S	1E	21	NESE	Long 103.997224	Lat 43.425795	3526	2/22/1964	3057	0	0	8 5/8-inch 0 to 269		Madison	Oil Test	API 40 047 05089	D
UNKNOWN																	
606	7S	1E	11	SWSW	1033713	428609	3668	UNK	UNK	UNK	UNK	UNK		Unknown	Unknown	D-16	B
636	7S	1E	11	NESW	1034774	429982	3698	UNK	UNK	UNK	UNK	7		Unknown	Unknown		GPS
652	7S	1E	2	NWSE	1036360	434742	3748	UNK	UNK	UNK	UNK	UNK		Unknown	Unknown		GPS
653	7S	1E	22	NWNE	1030679	422487	3569	UNK	UNK	UNK	UNK	UNK		Unknown	Unknown		GPS
654	6S	1E	34	NWNE	1032372	443410	3687	UNK	UNK	UNK	UNK	8		Unknown	Unknown		GPS
655	6S	1E	34	NENE	1033454	443307	3719	UNK	UNK	UNK	UNK	12		Unknown	Unknown		GPS

Notes: (1) Land elevations based on Digital Elevation Model (DEM).
UNK = Unknown

SOURCE A

WATER WELLS IN EDGEMONT PROJECT AREA

(Silver King Mines, Inc., May 1977, in a letter from Keith Andersen, Silver King Mines, Inc., to John Hatch, South Dakota Water Rights Commission, January 12, 1979)

This page intentionally left blank



WATER WELLS IN EDMONT PROJECT AREA

<u>Well No.</u>	<u>Location</u>
1	SE/4 SE/4 Sec. 9 T7S,R1E
2	SE/4 SE/4 Sec. 16 T7S,R1E
3	SW/4 NW/4 Sec. 22 T7S,R1E
4	SE/4 SE/4 Sec. 15 T7S,R1E
5	NE/4 NW/4 Sec. 14 T7S,R1E
6	NE/4 SE/4 Sec. 14 T7S,R1E
7	NW/4 NW/4 Sec. 23 T7S,R1E
8	NW/4 SE/4 Sec. 23 T7S,R1E
9	NE/4 NE/4 Sec. 23 T7S,R1E
10	NE/4 NE/4 Sec. 13 T7S,R1E
11	NW/4 SW/4 Sec. 24 T7S,R1E
12	SE/4 SE/4 Sec. 4 T7S,R1E
13	NW/4 NW/4 Sec. 3 T7S,R1E
14	NW/4 SW/4 Sec. 2 T7S,R1E
15	NW/4 NW/4 Sec. 2 T7S,R1E
16	NW/4 SE/4 Sec. 1 T7S,R1E
17	SE/4 NW/4 Sec. 12 T7S,R1E
18	NW/4 SW/4 Sec. 9 T7S,R1E
19	NW/4 NW/4 Sec. 18 T7S,R1E
20	NW/4 SW/4 Sec. 17 T7S,R1E
21	SW/4 NW/4 Sec. 19 T7S,R1E
22	NE/4 SW/4 Sec. 27 T40N, R60W
23	NW/4 NW/4 Sec. 29 T7S, R1E
24	NE/4 NW/4 Sec. 28 T7S,R1E
25	SE/4 NW/4 Sec. 27 T7S,R1E
26	SW/4 NE/4 Sec. 35 T7S,R1E
27	SE/4 SE/4 Sec. 33 T7S,R1E
28	NE/4 SW/4 Sec. 22 T8S,R2E
29	NE/4 NW/4 Sec. 16 T8S,R2E
30	SE/4 SE/4 Sec. 31 T7S,R2E
31	SW/4 NW/4 Sec. 31 T7S,R2E



<u>Well No.</u>	<u>Location</u>
32	SW/4 SW/4 Sec. 30 T7S,R2E
33	NW/4 SE/4 Sec. 25 T7S,R1E
34	NW/4 NW/4 Sec. 30 T7S,R2E
35	SW/4 NE/4 Sec. 19 T7S,R2E
36	NW/4 NE/4 Sec. 30 T7S,R2E
37	NW/4 SW/4 Sec. 18 T7S,R2E
38	SW/4 NW/4 Sec. 33 T6S,R1E
39	NE/4 NE/4 Sec. 29 T6S,R1E
40	NW/4 SW/4 Sec. 30 T6S,R1E
41	SW/4 NW/4 Sec. 31 T6S,R1E
42	SW/4 NE/4 Sec. 5 T7S,R1E
43	SE/4 SW/4 Sec. 34 T6S,R1E
44	NW/4 SE/4 Sec. 31 T7S,R2E
45	NW/4 NW/4 Sec. 5 T8S,R2E
46	SW/4 NE/4 Sec. 31 T7S,R2E
47	SW/4 SW/4 Sec. 32 T7S,R2E
48	SE/4 NW/4 Sec. 19 T6S,R1E
49	SW/4 SW/4 Sec. 29 T6S,R1E
50	SW/4 SW/4 Sec. 28 T41N,R60W
51	SW/4 NE/4 Sec. 9 T7S,R1E
52	NE/ SE/4 Sec. 30 T7S,R2E
53	SW/4 NE/4 Sec. 30 T7S,R2E
54	NE/4 SE/4 Sec. 25 T7S,R1E
55	NW/4 NE/4 Sec. 36 T7S,R1E
56	SE/4 SE/4 Sec. 32 T7S,R2E
57	NE/4 SE/4 Sec. 5 T8S,R2E
58	NW/4 NE/4 Sec. 31 T7S,R1E
59	NE/4 NW/4 Sec. 5 T8S,R2E
60	NE/4 SW/4 Sec. 33 T7S,R2E
61	NW/4 SE/4 Sec. 11 T7S,R1E
62	SW/4 SW/4 Sec. 25 T7S,R1E
63	SW/4 NW/4 Sec. 36 T7S,R1E



Continued - Page 3

<u>Well No.</u>	<u>Location</u>
64	SW/4 NE/4 Sec. 9 T8S,R2E
65	NW/4 NE/4 Sec. 9 T8S,R2E
66	NE/4 NW/4 Sec. 8 T8S,R2E
67	SE/4 NW/4 Sec. 8 T8S,R2E
68	NE/4 NE/4 Sec. 8 T8S,R2E
69	SW/4 SE/4 Sec. 25 T7S,R1E
70	SE/4 SW/4 Sec. 25 T7S,R1E
71	NW/4 SE/4 Sec. 6 T8S,R2E
72	NW/4 SE/4 Sec. 6 T8S,R2E
73	NE/4 SW/4 Sec. 6 T8S,R2E
74	NE/4 SW/4 Sec. 6 T8S,R2E
75	SW/4 SW/4 Sec. 17 T8S,R2E
76	SE/4 NW/4 Sec. 17 T8S,R2E
77	NW/4 NE/4 Sec. 17 T8S,R2E
78	NE/4 SE/4 Sec. 20 T8S,R2E
79	NE/4 SE/4 Sec. 27 T8S,R2E
80	SW/4 NW/4 Sec. 35 T8S,R2E
81	SW/4 NW/4 Sec. 14 T8S,R2E
82	SW/4 SW/4 Sec. 10 T8S,R2E
83	NE/4 SW/4 Sec. 14 T8S,R2E
84	SW/4 NW/4 Sec. 10 T8S,R2E
85	NE/4 SE/4 Sec. 28 T8S,R2E
86	NW/4 SW/4 Sec. 6 T8S,R2E
87	NW/4 NE/4 Sec. 1 T8S,R1E
88	NE/4 SE/4 Sec. 35 T7S,R1E
88	SE/4 SE/4 Sec. 35 T7S,R1E
89	NW/4 NE/4 Sec. 11 T8S,R1E
90	SE/4 NW/4 Sec. 23 T8S,R2E
91	SE/4 NW/4 Sec. 12 T8S,R2E
92	SE/4 SW/4 Sec. 23 T8S,R2E
93	SE/4 NE/4 Sec. 2 T8S,R2E
94	SW/4 SW/4 Sec. 34 T7S,R2E



Continued - Page 4

<u>Well No.</u>	<u>Location</u>
95	SE/4 Sec. 25 T40N,R61W
96	SW/4 SW/4 Sec. 22 T41N,R60W
97	Not Located
98	SW/4 NW/4 Sec. 17 T41N,R60W
99	NE/4 NE/4 Sec. 17 T41N,R60W
100	NW/4 SE/4 Sec. 7 T41N,R60W
101	SW/4 NE/4 Sec. 1 T41N,R61W
102	SW/4 NE/4 Sec. 18 T6S,R1E
103	NW/4 NW/4 Sec. 10 T41N,R60W
104	NW/4 SW/4 Sec. 10 T41N,R60W
105	SE/4 NW/4 Sec. 9 T41N,R60W
106	NE/4 NE/4 Sec. 18 T6S,R1E
107	SE/4 NE/4 Sec. 18 T6S,R1E
108	SE/4 NE/4 Sec. 18 T6S,R1E
109	NE/4 NW/4 Sec. 17 T6S,R1E
110	NE/4 NE/4 Sec. 17 T6S,R1E
111	NW/4 NE/4 Sec. 17 T6S,R1E
112	SE/4 Sec. 16 T6S,R1E
113	NE/4 SW/4 Sec. 6 T7S,R2E
114	NE/4 SW/4 Sec. 7 T7S,R2E
115	SE/4 NE/4 Sec. 18 T6S,R1E
116	SE/4 NE/4 Sec. 18 T6S,R1E
117	SW/4 SE/4 Sec. 8 T6S,R1E
118	NE/4 SE/4 Sec. 7 T6S,R1E
119	NW/4 NW/4 Sec. 8 T6S,R1E
120	NW/4 SW/4 Sec. 5 T6S,R1E
121	SW/4 SW/4 Sec. 31 T5S,R1E
122	NE/4 NW/4 Sec. 30 T5S,R1E
123	NE/4 NW/4 Sec. 21 T42N,R60W
124	NW/4 SW/4 Sec. 18 T5S,R1E
125	SW/4 SW/4 Sec. 6 T6S,R1E



Continued - Page 5

<u>Well No.</u>	<u>Location</u>
126	SE/4 SW/4 Sec. 16 T41N,R60W
127	SW/4 NE/4 Sec. 7 T41N,R60W
128	NW/4 SE/4 Sec. 1 T41N,R61W
129	Sec. 7 Sec. 5 T41N,R60W
130	
131	NW/4 SE/4 Sec. 4 T8S,R2E
132	NW/4 SE/4 Sec. 4 T8S,R2E
133	
134	SE/4 NW/4 Sec. 29 T40N,R60W



Water Wells in Edgemont Project Area

Map #	Owner	Use	Depth	Probable Aquifer	Remarks
1	Peterson & Son Inc.	Stock	600	K 1	Flowing 1.1 gpm, stopped during test. Casing was cut off closer to ground & flow recovered to 1.3 gpm, 6 wks after test.
2	Peterson & Son Inc.	Domestic	640	K 1	Flowing est. 15 gpm.
3	Peterson & Son Inc.	Stock	Oil test		Flowing 3 gpm.
4	Peterson & Son Inc.	Stock	Oil Test		Couldn't measure- broken out around casing. Also used by Glen Peterson for garden.
5	Peterson & Son Inc.	Stock	Oil Test		Plugged at 850", possible Sundance flow. Flowing 6.6 gpm, slowed to 5 gpm during test
6	Glen Peterson	Stock	280'	K f	SWL 11'2", Siphon Arrangement into tank.
7	Glen Peterson " "	Domestic	500' 200"	K 1 K f	Flowing 4.25 gpm. Slowed to 3.6 during test SWL 12' 8"
8	Leslie Coates " "	Domestic	500 240	K 1 K f	Flowing 4.2 gpm. Flow est. 1 gpm. Pumped to house.
9	Leslie Coates	Stock	90 ?	K f	Flowing 2.5 gpm.
10	Leslie Coates	Stock	200	K 1	SWL 78' New well
11	Leslie Coates	Stock	Oil test		Flowing 5 gpm.
12	Leslie Coates	Stock	730'	K 1	Flowing 0.6 gpm, slowed to < 0.1 gpm during test. Recovered to 0.3 gpm after 6 weeks.
13	Miles Spencer	Domestic	500	K 1	Flowing 2.5 gpm., slowed to 1.2 gpm during test, Recovered to 2.0 gpm after 6 weeks.
14	Earl Darrow	Stock	470	K 1	Barely flowing. Stopped during test. SWL recovered to 1.0 ft.
15	Earl Darrow	Stock	280	K 1	Pump jack, couldn't measure accurately SWL approximately 24'
16	Earl Darrow	Stock	330	K 1	New well, SWL 157' 7"
17	H. P. Heck	Stock	156	K f	Windmill, couldn't measure
18	Dick Andersen	Domestic	527	K f	Flowing 7.5 gpm.



Water Wells in Edgemont Project Area

Map #	Owner	Use	Depth	Probable Aquifer	Remarks
19	Dick Andersen	Stock	740	K f	Pump jack, couldn't measure.
20	Edwin Andersen	Domestic	530	K f	Flowing 4.5 gpm.
21.	Tubbs Ranch	Stock	910	K f	Flowing 14 gpm.
22.	Coates, Andersen	Stock	800	K f	Pump jack, reported SWL 30'
23	Tubbs Ranch	Stock	600	K f	Flowing 0.8 gpm.
24	Tubbs Ranch	Domestic			Siphon arrangement, water level 23'
25	Tubbs Ranch	Stock			Windmill, couldn't measure, reported to barely flow.
26	Tubbs Ranch	Stock	350	K f	Windmill, couldn't measure, reported to barely flow.
27	Tubbs & Schultz	Stock	900	K l	Submersible pump to pipeline. SWL 15'
28	Tubbs Ranch	Stock	300	K f	Will flow 20 gpm. H2S
29	B. Childers	Stock			Wild well, flowing est. 35 gpm. H2S around casing.
30	Harold Dodson	Domestic	120	K f	Barely flows, pumped to house.
	" "	Stock	120	K f	Flows 0.75 gpm
31	F. A. Heck	Domestic	104	K f	Flows 1.3 gpm.
32	Tony Bryan	Domestic	90	K f	Pumped to house, couldn't measure, flow est. 1/2 gpm.
33	H. P. Heck	Domestic	96	K f	Piped into house, flowing reported 1.25 gpm
34	Tony Bryan	Stock	330	K l	2 wells, one no flow & not used, one flows 1.5 gpm.
35	Tony Bryan	Stock	148	K l	Pumped well, not visited.
36	Tony Bryan	Stock	255	K l	Flowing 10 gpm .
37	Tony Bryan	Stock	145	K l	Pumped well, not visited
38	Lloyd Putnam	Stock	550	K l	Flowing 1.5 gpm.
39	Norris Darrow	Stock	700	K l	Windmill, reported SWL 15'
40	Norris Darrow	Domestic	660	K l	Two wells piped together, both flow, but couldn't measure
		Domestic	700	K l	



Water Wells in Edgemont Project Area

Map #	Owner	Use	Depth	Probable Aquifer	Remarks
1	Robert Bakewell	Domestic			Flows 12 gpm.
2	Lloyd Putnam	Domestic	600	K 1	Flows est. 25 gpm.
3	Preston Richardson	Domestic	350	K 1	Submersible pump, couldn't measure, stopped flowing when old Triangle mine dewatered.
4	Harold Dodson	Stock	130	K f	Will flow est. 40 gpm.
5	Harold Dodson	Stock	190	K f	Flows 3.1 gpm. H2S
6	Harold Dodson	Stock	Oil test	K f	Plugged at 140', but couldn't measure. Flowing around casing.
7	Harold Dodson	Stock	90	K f	SWL 10'
8	Norris Darrow	Stock	725	K 1	Will flow est. 60 gpm.
9	Norris Darrow	Stock	600	K 1	Flows 5 gpm.
50	Lloyd Putnam	Stock	609	K 1	Flows 1.5 gpm., may be 2 wells piped together.
51	Burlington R.R.	Stock	550	K 1	Flows 15.5 gpm., used by Leslie Coates.
52	Tony Bryan	Stock			Flows 2.8 gpm.
53	Tony Bryan	Stock			Windmill, couldn't measure.
54	Tony Bryan	Stock	90	K f	Flows 0.5 gpm.
55	Tony Bryan	Stock	92	K f	Flows 9 gpm.
56	Effie Gow	Domestic	300	K 1	Broken out around casing, flowing
57	Effie Gow	Garden	270	K 1	Couldn't measure, reported 100+ gpm. H2S Used by Rev. Brown to irrigate garden.
58	F. A. Heck	Stock	100+	K f	Flows 4 gpm.
59	F. A. Heck	Stock	118	K f	Flows 2.8 gpm H2S
60	F. A. Heck	Stock			Windmill, couldn't measure.
61	Earl Darrow	Stock	525	K 1	Pumpjack, couldn't measure.
62	F. A. Heck	Stock			Couldn't measure, flowing est. 2 gpm into covered tank.



Map #	Owner	Use	Depth	Probable Aquifer	Remarks
63	Tony Bryan	Stock	100+	K f	Flows 1.5 gpm.
64	Leonard McElhanev	Stock			Flows 5 gpm H2S, may flow more through big valve.
65	" "	?			2 wells, one windmill, SWL 15', neither apparently used.
66	" "	Stock			Valve at well head shut off except for small line to H. Dodson's stock tank. Reported by Keene as flowing 270 gpm. in 1970
67	Leonard McElhanev	Stock			Flows 25 gpm. H2S.
68	" "	Domestic	230	K l	Piped to house, couldn't measure.
		Stock	230	K l	Flows 6 gpm.
69	H. P. Heck	Stock	130	K f	Flows 1.2 gpm.
70	H. P. Heck	Stock	375	K f, K l	Flows 1.0 gpm.
71	Ed Benton	Domestic		K f	Pumped to house, reported to barely flow
72	Ed Benton	Stock	212	K f	Yard water, Flows 13 gpm H2S
73	Ed Benton	Stock	560	K l	Flows 1.6 gpm.
74	Ed Benton	Stock	305	K f	Casing rusted out, flows, couldn't measure
75	Ed Benton	Stock	430	K f	Windmill, reported to pump dry
76	Ed Benton	Stock	420	K f	Broken out around casing, est. 7 or 8 gpm.
77	Darrell Heldman	Stock	400	K f	Broken out around casing, est. 5 gpm.
78	" "	"	410	K f	Pump jack, Keene reports SWL 30'
79	B. Childers	Domestic	337	K f	Couldn't measure, pump set at 250'
80	" "	Stock	650	K l	Pump jack, Keene reports SWL 100'
81	" "	"	440	K l	Flows 4 gpm, sl. H2S
82	" "	"	200	K f	Flows 9 gpm., H2S
83	" "	"	270	K f	Pump jack, couldn't measure.



Map #	Owner	Use	Depth	Probable Aquifer	Remarks
84	Dick Miller	Stock	155	K f	Flows 0.25 gpm.
85	Tubbs Ranch	Domestic	415	K f	Pumped to house, Reported SWL 30'
86	Tubbs Ranch	Stock	360	K f	Pump jack, SWL reported 20'
87	Tubbs Ranch	Appears abandoned	380	K f	Plugged with wooden plug. Reported SWL 20'
88	Tubbs Ranch	Appears abandoned	320	K f	Two wells, one may be caved in, one SWL 10'
89	Porter & Benton	Pipeline	860	K l	Submersible pump, runs extensive pipeline. SWL reported 5'
90	B. Childers	Stock	Oil test		SWL 1.0'
91	Carl Reutter	Stock	150	K f	Windmill SWL 34'
92	Carl Reutter	Domestic	298	K f	Pumped to house, Keene reports SWL 132'
93	Bob Runge	Domestic	200	K l	Two wells, couldn't measure, Keene reports SWL 80'
94	Bob Runge	Stock	200+	K l	Flows 0.75 gpm.
95	Wayne Jackson	Pipeline	860 880	K f	Barely flows, submersible pump to pipeline.
96	Billy Stearns	Domestic	560	K l	Flows 4.8 gpm.
97	Billy Stearns	Stock		K l	Uranium test cased to 200', hole reported to be caving below that & sealing off flow. Flows.
98	Billy Stearns	Stock	Oil test		Leaking around top of casing, flows est 2 g
99	Gerald Darrow	Domestic	420	K l	Flows 2.2 gpm.
100	" "	Stock	530	K l	Flows 150 gpm (by Hodson) apparently used to fill water trucks.
101	" "	Morresy Pipeline	665	K l	Pipeline serves ranches west, submersible pump. Hodson reports flow 3 gpm.
102	Lloyd Darrow	Domestic	267	K l	Will flow est. 100 gpm. Sells water
103	Lloyd Darrow	Stock	350	K l	Flows 1.3 gpm.



Water Wells in Edgemont Project Area

Map #	Owner	Use	Depth	Probable Aquifer	Remarks
104	Lloyd Darrow	Stock		K J	Jensen jack, reported SWL 6'
105	Lloyd Darrow	Stock		K I	Not visited, reported SWL 8 to 10'
106	Lloyd Darrow	Stock			Flows 3.5 gpm.
107	Earl Darrow	Domestic	90	K f	Pumped into house, flow est. 1 gpm.
108	Chet Taylor	Domestic	90	K f	Taylor lives here part of time. Info reported by Earl Darrow. Flow rep. 1 gpm
109	Vivian Cook	Domestic	220	KI	Reported SWL 22'
110	Vivian Cook	Stock	240	K I	Reported SWL 30'
111	Vivian Cook	Not used	100	K f	Owner plans to develop, reported SWL 5'
112	Miles Spencer	Stock	120	K f	Windmill, couldn't measure.
113	Miles Spencer	Stock			Back up well for Spencer pipeline.
114	No info				Forest Service.
115	Bud Hollenbeck	Domestic		K f	Flows 3 gpm.
116	Bud Hollenbeck			K f	Flows 2.75 gpm. At Dewey Post Office.
117	Bud Hollenbeck	Stock Garden			Submersible Pump. SWL 27'
118	Bud Hollenbeck	Stock	Oil test		Flowing out of casing at ground level
119	Bud Hollenbeck	Stock			Submersible pump, reported SWL 6'
120	Forest Service	Stock			Pumpjack, couldn't measure.
121	Bud Hollenbeck	Stock	430	K I	Will flow?? est. 100 gpm.
122	Bud Hollenbeck	Stock			Windmill, couldn't measure.
123	Bud Hollenbeck	Stock			Pump jack, couldn't measure.
124	Bud Hollenbeck	Stock			Not visited, reported windmill.
125	Bud Hollenbeck	Stock			Casing rusted off. Flows at ground level.
126	Francis Carr	Domestic		K I	Flows, couldn't measure.
127	Francis Carr	Stock	Oil test	K I	Casing rusted off, flows at ground level.



Water Wells in Edgemont Project Area

Map #	Owner	Use	Depth	Probable Aquifer	Remarks
128	Francis Carr	Stock	Oil test	K 1	Couldn't measure, est. 5 gpm.
129	There are several old oil tests in this area. The ones reported as being used are reported above. There appears to be some flow from some of these but the casings seem to be bad and all there is now are some marshy areas. Some use of water for stock from these is possible.				
130	Dick Miller	Domestic	155	K f	?
131	Dick Miller	Stock	110	K f	Flows 0.8 gpm
132	Dick Miller	Stock	300	K 1	Flows est. 2 gpm
133	Dick Miller	Stock	300	K 1	Not contacted. Information from Keene
134	Roberts & Daniels	Stock	860		



No.	S.	to Electricity	Dia.	Condition	Setting, Capacity, Age, etc.	Use	Requirement
1	S	300 ft.	4"	25 yrs. - fair	none		
2	D.S.I.	300 ft.	5"	45 yrs. - poor	none		casing rusted out - flowing around casing
3	S	1/2 mile	4"	10 yrs.	none		oil test open hole from top of F. R.
4	S.I.	700 ft.	3"	10 yrs. - poor	none		oil test flowing around casing
5	S	2 miles	5"	10 yrs. - fair	none		oil test - open hole from top of FR
6	S	1 mile	12"	20 yrs.	none		
7	FR	D	on site	6"	20 yrs.	jet pump at 25 ft.	
7	LAK	S.I.	" "	5 1/2"	40 yrs. - poor	none	
8	FR	D.I.	on site	6"	45 yrs. - poor	jet pump in basement	
8	LAK	S.I.	on site	6"	45 poor	none	
9	S	1 mile	6"	10 yrs.	none		
10	S	2 miles		2 yrs. - good	pump jack		
11	S	1/2 mile	8"	10 yrs.	none		oil test
12	S	2000 ft.	4 1/2"	10 yrs. - poor	none		open hole from top FR
13	D.S.I.	on site	5"	20 yrs. - fair	none		
14	S	1/2 mile	4"	poor	none		first pump test stopped flow - well not used since flow stopped
15	S	on site	4"	fair	cylinder type		



Well #	D. S.	Distance to Electricity	Well Dia.	Age and Condition	Pump Information-Type Setting, Capacity, Age, etc.	Season of Use	Water Requirement	Remarks
16	S	on site	4½"	1 yr. - good	no pump installed yet			
17	S	2 miles	UNK.		windmill			
18	D.S.I.	on site	4"	48 yrs.	pressure pump			
19	S	1 mile	6"	16 yrs. - fair	pump jack			
20	D.S.I.	on site	6"	51 yrs. - poor	shallow well jet pump			casing rusted out - was repaired
21	S	1½ mile	7"	65 yrs.	none			oil test
22	S	on site	3"	10 yrs. - good	cylinder type			
23	S	1 mile	6"		none			
24	D.S.	on site	3"		none			
25	S	2 miles	4½"		windmill			
26	S	1 mile	5"		windmill			
27	S	on site	12"		submersible pump			serues pipeline
28	S	1/2 mile	6"	poor	none			
29	S	1/2 mile	5"	poor	none			casing rusted out
30	D.I.	on site	6"	24 yrs.	deep well jet pump set @ 80 ft			



Well #	D. S.	Distance to Electricity	Well Dia.	Age and Condition	Pump Information-Type Setting, Capacity, Age, etc.	Season of Use	Water Requirement	REMARKS
30	S	on site	6"	cleaned 1977 22 years	none			
31	D.S.I.	on site	5½"	28 yrs.	none			
32	D.S.I.	on site	6"		pump type unknown			
33	D.S.	on site	5"	32 yrs.	none			
34	S	1 mile	2½"		none			2 wells - one does not flow and is not used
35		2 miles	8"	poor	windmill			
36	S	1½ mile	4"	poor	none			
37		2½ miles	5½"	poor	cylinder type			
38	S	½ mile	4"	26 yrs.	none			
39	S	½ mile	5"	poor	windmill			
40	D.S.I.	on site	6"	8 yrs.	none) piped together
40	D.S.I.	on site	6"	31 yrs. poor	none			
41	D.S.I.	on site	6"		submersible			serves pipeline
42	D.S.I.	on site	5"	33 yrs. poor	none			casing rusted out and repaired
43	D	on site	4"	poor	submersible			



Well #	D. S.	Distance to Electricity	Well Dia.	Age and Condition	Pump Information-Type Setting, Capacity, Age, etc.	Season of Use	Water Requirement	Remarks
44	S	1/2 mile	6"	20 yrs.	none			
45	S	on site	4"	8 yrs. poor	none			
46	D.S.I.	1/2 mile	6"	18 yrs. poor	none			oil test - leaking around casing
47	D.S.I.	on site	6"	18 yrs. fair	none			
48	S	on site	2 1/2"	10 yr.	none			
49	S	1 mile	4"	3 yrs.	none			
50 N	S	2 miles	4"	40 yrs. poor	none			
50 S	S	2 miles	6"	5 yrs. poor	none			surface casing only ?
51	S	1 mile	10"	80 yrs. poor	none			repaired 1930's ?
52	S	1/2 mile	2 1/2"		none			
53	S	1 mile	6"		windmill			
54	S	1500 ft.	6"		none			
55	S	2000 ft.	6"		none			
56	D.S.I.	on site	3"	10 yrs. poor	submersible			leaking around casing
57	S.I.	1/2 mile	4"		none			



Well #	D. S.	Distance to Electricity	Well Dia.	Age and Condition	Pump Information-Type Setting, Capacity, Age, etc.	Season of Use	Water Requirement	REMARKS
58	S	100 ft.	6"		none			
59	S	1500 ft.	4"	poor	none			
60	S	1 mile	UNK.		windmill			
61	U	3 miles	5"		pump jack			
62	S	1½ mile	6"	1 yr. good	none			well replaced 1977
63	S	2000 ft.	5"		none			
64	S	1/2 mile	2½"	poor	none			
65	U	1/2 mile	6"	poor	none			
66	S	Approx. ½ mile	5"		none			
67	S	Approx. ½ mile	5"	poor	none			
68	D	on site	4"		none			
68	S.I.	on site	4"		none			
69	S	400 ft.	6"	18 yrs.	none			
70	S	2000 ft.	4"	7 yrs. poor	none			open hole from top Fall River
71	D	on site	5"		pump type unknown			



Well #	D. S.	Distance to Electricity	Well Dia.	Age and Condition	Pump Information-Type Setting, Capacity, Age, etc.	Season of Use	Water Requirement	Remarks
72	S.I.	on site	6"	32 yrs. poor	none			
73	D.S.I.	on site	5"	2 yrs. good	submersible			
74	S	1/2 mile	5"	30 yrs. poor	none			casing rusted out
75	S	Approx. 1 mile	5"		windmill			pumps dry
76	S	Approx. 1 1/2 mile	7"	18 yrs. poor	none			casing rusted out
77	S	Approx. 1 1/2 Mile	5"	poor	none			casing rusted out
78	D.S.	on site	5"		cylinder			
79	D.S.I.	on site	6"		submersible set at 250'			
80	S	Approx. 3000 ft.	6"		cylinder			
81	S	Approx. 1 1/2 mile	4"		none			
82	S	Approx. 1 1/2 mile	4 1/2"		none			
83	S	Approx. 1 mile	6"		cylinder			
84	S	Approx. 1 mile	2"		none			
85	D	on site						
86	S	1/2 mile	4"	poor	cylinder			stopped flowing when well #66 flowing uncontrolled about 1970



Well No.	D. S.	Distance to Electricity	Well Dia.	Age and Condition	Pump Information-Type Setting, Capacity, Age, etc.	Season of Use	Water Requirement	Remarks
87	U	3/4 mile	4"	poor	none			same as 86
88	S.U.	1500 ft.	8"	poor	none			was used with pump jack in 1977 - not used in 1978
88	S	on site	6"		pump type unknown probably submersible			serues pipeline
89	D.S.	on site	6"	good	submersible			serues pipeline
90	S.U.	on site	6"		none			oil test
91	S	1 mile	5"		windmill			
92	D.S.I.	on site	4 1/2"		submersible			
93	D.S.I.	on site	2"		submersible			
93	S.U.	on site	6"		none			
94	S	on site	5"		none			
95	D.S.I.	on site	10"		submersible			serues pipeline
96	D.S.I.	on site	5"		none			
97	S	1 mile	4"	poor	none			cased to 200'
98	S	2 miles	10'	poor	none			oil test
99	D.S.I.	on site	4"		none			



Well #	D. S.	Distance to Electricity	Well Dia.	Age and Condition	Pump Information-Type Setting, Capacity, Age, etc.	Season of Use	Water Requirement	Remarks
100	S		8"		none			
101	D S	on site	7"		submersible			serues extensive pipeline
102	DSI	on site	5"	fair	none			
103	S	1 mile	4"		none			
104	S	1 mile	4½"		Jensen jack			
105	S	3 miles	4"		pump jack			
106	S	1/2 mile	4"		none			
107	DSI	on site	5"	poor	none			
108	DSI	on site	6"	poor	none			
109	DSI	on site	6"		submersible - set @ 90'			
110	SI	on site	6½"		submersible			
111	SU	200 ft.	4"		none			
112	S	1 mile	4½"		windmill			
113	S	2 miles	UNK		windmill			
114	S U	3 miles	UNK		windmill			

D. S.	Distance to Electricity	Well Dia.	Age and Condition	Pump Information-Type Setting, Capacity, Age, etc.	Season of Use	Water Requirement	Remarks
DSI	on site	3½"		jet pump			
U	on site	1"		none			
S.I.	on site	6"		submersible pump			
S	1500 ft.	9½"	poor	none			oil test
S	on site	5"		submersible pump			
S	on site	2"		pump jack			
S	1½ mile	5"		none			
S	5 miles	7"		windmill			
S	4½ mile	6"		cylinder			
S	5 miles	4"		windmill			
S	1½ miles	6"	poor	none			casing rusted off
DST	on site	6½"		none			
S	2 miles	6"	poor	none			oil test - casing rusted off
S	2½ miles	2"	poor	none			oil test



Well #	D. S.	Distance to Electricity	Well Dia.	Age and Condition	Pump Information-Type Setting, Capacity, Age, etc.	Season of Use	Water Requirement	Remarks
130	U	on site	UNK		none			covered up by owner H ₂ S is not used
131	S	200 ft.	3"		none			
132	S.U.	on site	approx. 5"		pump type unknown			
133	U	1500 ft.	6"		none			
134	S.U.	on site	1"		UNK			

SOURCE B

DRAFT ENVIRONMENTAL STATEMENT FOR EDGEMONT URANIUM MINE TABLE 2.5.2-1

(Tennessee Valley Authority, 1979)

This page intentionally left blank



Table 2.5.2-1
Summary of Wells Within a Four-Mile (6.5 km.) Radius of the
TVA Burdock, No. 1 Shaft Site

Well No.: Based on the Federal system of township and range. Each township within the project area is assigned a letter in consecutive order beginning with "A" in the northeast corner and ending with "Z" in the southern part. Similarly, wells are numbered in consecutive order within a township--for example: B-1, B-2, etc. Location: Number based on township, range, section, 1/4 section, and 1/4 section. Aquifer: Qa, Quaternary alluvial deposits; K1, Cretaceous, Fall River Formation; K2, Cretaceous, Dakota Formation; Jm, Jurassic, Morrison Formation; Js, Jurassic, Sundance Formation; Trs, Triassic, Spearfish Formation; Perm, Permian, Minnetakhta Limestone. Depth: Given in feet (ft.) and meters (m.) below land surface. Use Rate and Flow Rate: In gallons per minute (gpm) and liters per second (l/s). Elevation of Land Surface and Elevation of Water Surface: In feet (ft.) and meters (m.) above sea level. Superscript a indicates flow rate less than 1 gpm. Superscript b indicates estimated water surface elevations.

Well No.	Latitude	Longitude	Location	Aquifer	Depth		Use Rate		Flow Rate		Elevation		Remarks		
					(ft.)	(m.)	(gal/min)	(l/s)	(gal/min)	(l/s)	Land Surf. (ft.)	Water Surf. (m.)			
621 B-1	43°30'00"	103°58'57"	6-1-270b	Qa	50	15	30	1.9	-	-	3715	1132	3700	1128	
502 B-2	43°29'58"	103°58'57"	6-1-270b	Qa	46	14	30	1.9	-	-	3715	1132	3700	1128	
41 B-3	43°29'10"	104°02'43"	6-1-318d	-	-	-	-	-	12	.8	3603	1099	3610	1100	
38 B-4	43°29'09"	104°03'40"	6-1-338c	K1	350	166	-	-	2	.7	3130	1106	3630 ^b	1106	
49 B-4	43°28'51"	103°59'06"	6-1-340c	K1	350	107	-	-	-	-	3662	1116	-	-	Flowed until Triangle mine de-watered. 1/3 h.p. pump.
16 B-1	43°28'20"	103°56'47"	7-1-18d	K1	330	101	-	-	-	-	3975	1190	3747	1146	
638 B-2	43°28'32"	103°57'34"	7-1-2Aa	K1	180	55	10	.6	-	-	3749	1143	-	-	Water contains iron.
75 B-3	43°28'36"	103°58'15"	7-1-2Bb	K1	495	151	-	-	a	-	3705	1129	3703 ^b	1129	Unused.
643 B-4	43°28'28"	103°58'20"	7-1-2Bc	K1	280	85	5	.3	-	-	3658	1127	3674	1120	Water contains iron.
14 B-5	43°28'01"	103°58'22"	7-1-2Cc	K1	470	143	-	-	4	-	3679	1121	3680 ^b	1122	Unused.
13 B-6	43°28'38"	103°59'42"	7-1-3Bb	K1	500	152	-	-	2	-	3860	1116	3681 ^b	1116	A.E.C. water analysis.
12 B-7	43°28'02"	104°00'00"	7-1-4D4	K1	805	245	-	-	1	.06	3645	1111	3646	1111	
20 B-8	43°28'17"	104°01'19"	7-1-5Ac	K1	600	183	-	-	25	1.6	3600	1087	3610 ^b	1100	Flow rate in 1969, 30 gpm (1.8 l/s).
51 B-9	43°27'30"	103°59'52"	7-1-9A4	K1	530	160	-	-	16	1.0	3615	1102	3620 ^b	1103	Water contains iron & sulphur.
18 B-10	43°27'03"	104°00'54"	7-1-9Cc	K1	327	101	-	-	8	.5	1700	1128	3701 ^b	1128	



TABLE 2.5.2-1 (continued)

Well No.	Latitude	Longitude	Location	Aquifer	Depth		Use Recs		Flow Recs		Elevation		Remarks		
					(Ft.)	(m)	(gal/min)	(l/s)	(gal/min)	(l/s)	Land Surf. (ft)	Water Surf. (m)			
1 0-11	43°27'05"	103°59'46"	7-1-100d	KI	600	183	-	-	1	.06	3624	1105	3631	1107	Water contains iron.
61 0-12	43°27'06"	103°57'47"	7-1-110c	KI	525	160	-	-	-	-	3700	1128	-	-	A.E.C. water analysis.
17 0-13	43°28'25"	103°58'53"	7-1-120d	KI	156	48	-	-	-	-	3750	1143	-	-	
10 0-14	43°27'04"	103°56'21"	7-1-120d	-	-	-	-	-	-	-	3830	1167	-	-	
10 0-15	43°26'58"	103°56'12"	7-1-135a	KI	200	61	-	-	-	-	3740	1140	3683	1116	
6 0-16	43°26'54"	103°58'24"	7-1-140b	-	-	-	-	-	-	-	3675	1120	3674	1120	
5 0-17	43°44'45"	103°58'25"	7-1-140a	KI	850	259	-	-	7	.4	3630	1106	3634	1108	Water contains iron.
(69) 5 0-18	43°25'23"	103°57'48"	7-1-140b	KI	280	85	1	.06	-	-	3610	1100	3596	1097	
4 0-19	43°26'39"	103°58'43"	7-1-150d	-	2264	690	-	-	-	-	3576	1090	3586	1091	
2 0-20	43°26'18"	103°59'58"	7-1-170d	KI	640	195	-	-	15	.9	3585	1084	3586	1085	A.E.C. water analysis.
20 0-21	43°26'18"	104°02'01"	7-1-170b	KI	530	162	-	-	4	.3	3555	1084	3558	1084	A.E.C. water analysis.
19 0-22	43°26'33"	104°03'06"	7-1-180c	KI	740	225	-	-	-	-	3700	1128	-	-	
21 0-23	43°25'46"	104°03'12"	7-1-180c	KI	910	277	-	-	15	.9	3580	1097	3580	1093	
3 0-24	43°25'46"	103°59'31"	7-1-220c	-	2400	732	-	-	3	.2	3548	1081	3580	1082	
9 0-25	43°25'59"	103°57'24"	7-1-230a	KI	90	27	-	-	3	.2	3625	1106	3625	1105	Flow rate 1969, 10 gpm (.6 l/s).
7002 0-26	43°26'02"	103°58'26"	7-1-230b	KI	500	152	-	-	5	.3	3574	1089	3574 ^b	1089	
7 0-27	43°26'03"	103°58'28"	7-1-230b	KI	200	61	3	.2	-	-	3574	1089	3561	1085	
8002 0-28	43°26'26"	103°57'46"	7-1-230c	KI	600	182	-	-	5	.3	3542	1080	3542 ^b	1080	Casing perforated in 10 ft (3 m.) intervals below elevations 3222 (982 m.) and 3384 (1031 m.).
8 0-29	43°25'27"	103°57'44"	7-1-230c	KI	240	73	-	-	1	.06	3542	1080	3542 ^b	1080	
503 0-30	43°25'24"	103°57'30"	7-1-230d	Js-Pmk	1470	448	-	-	5	.3	3550	1082	3550	1082	
115-31	43°25'35"	103°57'07"	7-1-240b	Js-Pmk	2480	756	-	-	6	.4	3477	1060	3477	1061	
70 0-32	43°25'25"	103°56'58"	7-1-250a	KI	375	114	-	-	2	.1	3508	1068	3508	1069	
3 0-33	43°26'45"	103°56'37"	7-1-250b	KI	94	29	-	-	1	.06	3510	1070	3510	1070	
54 0-34	43°26'46"	103°56'29"	7-1-250b	KI	90	28	-	-	1	.06	3428	1075	3428	1075	

D-14
not in
database
56



TABLE 2.5.2-1 (continued)

Well No.	Latitude	Longitude	Location	Aquifer	Depth		Use Rate		Flow Rate		Elevation		Remarks	
					(ft)	(m)	(gal/min)	(l/s)	(gal/min)	(l/s)	Land Surf. (ft) (m)	Water Surf. (ft) (m)		
9	43°24'28"	103°56'28"	7-250c	KF	130	40	-	-	1	.06	3510	1070	3510 ^b	1070
504	43°24'30"	103°56'25"	7-250d	KF	480	137	-	-	3	.2	3508	1069	3508 ^b	1069
505	43°24'42"	103°57'55"	7-24Ca	KI	260	79	-	-	2	.1	3530	1076	3530 ^b	1076
8	43°24'47"	103°58'27"	7-27Ac	KF	350	107	-	-	-	-	3560	1085	3560 ^b	1085
2	43°25'01"	104°02'18"	7-283a	KF	600	183	-	-	-	-	3576	1090	3583 ^b	1083
23	43°25'01"	104°02'18"	7-295b	KF	600	183	-	-	1	.06	3590	1094	3590 ^b	1094
3	43°25'30"	104°02'18"	7-310c	KI	600	183	-	-	-	-	3670	1119	-	-
2	43°26'05"	103°57'15"	7-35Ac	KF	350	107	-	-	1	.06	3545	1081	3545 ^b	1081
8	43°26'42"	103°57'15"	7-35Ca	KF	320	98	-	-	-	-	3555	1084	2845	1081
8802	43°23'37"	103°57'27"	7-355d	KF	320	98	-	-	-	-	3565	1084	-	-
87	43°23'10"	103°56'10"	7-36Aa	KF	92	28	-	-	9	.6	3500	1067	3504 ^b	1068
63	43°23'55"	103°56'17"	7-36Ca	KF	100	30	-	-	1.5	.2	3535	1077	3536 ^b	1078
113	43°28'08"	103°55'10"	7-30Ca	-	40	12	-	-	-	-	3660	1177	-	-
114	43°27'11"	103°55'48"	7-30C	-	365	111	-	-	-	-	3755	1145	3475	1059
506	43°27'32"	103°56'45"	7-35C	Jc	470	143	-	-	-	-	3970	1210	-	-
80	43°28'57"	103°55'15"	7-2-198a	KI	145	44	-	-	-	-	3640	1109	-	-
35	43°28'38"	103°55'05"	7-2-192a	KI	148	45	-	-	-	-	3620	1103	-	-
508	43°25'15"	103°55'27"	7-2-190c	KI	255	78	-	-	10	.6	3620	1087	3605 ^b	1089
30	43°26'11"	103°55'11"	7-2-32A	-	-	-	-	-	-	-	3620	1087	-	-
30	43°26'13"	103°55'10"	7-2-32B	KI	330	101	-	-	2	.1	3530	1076	3530 ^b	1076
32	43°26'27"	103°55'10"	7-2-36C	KF	60	27	-	-	4	-	3522	1074	3522 ^b	1074
31	43°26'07"	103°55'32"	7-2-313c	KF	104	32	-	-	1.3	.08	3485	1065	3505 ^b	1067

57

E-7
not
in
database

Slight flow in 1969; no flow in 1976.
1969 Flow, 15 gpm (.9 l/s); no flow in 1978.

Unused.

Flow rate in 1969, 2 gpm (.1 l/s); no flow in 1976; unused.

This page intentionally left blank

SOURCE C
SOUTH DAKOTA WELL COMPLETION REPORTS

This page intentionally left blank



NOTICE OF WELL CONSTRUCTION

1 of 1
7-1-16

Feltkin

(1) WELL CONSTRUCTION

Location of well: SE 1/4 SE 1/4 Section 16 Township 7S Range 1E

Well owner: Peterson & Son, Inc. Edgemont, SD
(Name) (Address)

Date well drilling completed: 11-17-81 Purpose of well: Domestic
(Domestic, irrigation, municipal, industrial, other)

WELL LOG

Layers, top to top in feet	Description of layer
0-380	Blk Sh
380-470	1B gy cist & ss
470-495	Gy ss & cist
495-565	Gy, rd-brn & gn cist
565-580	Gy ss
580-650	Gy cist

Depth to top of water producing equifer: 555
Depth to static water level: flowing
Name of producing equifer (if known): Lakota
Total depth of drill hole: 650
Depth to bottom of casing: 650

Casing information: In the space below show kind, size, weight, length, and diameter, etc., for production casing and surface casing, if present.
4" blk iron 10#/ft

Screen information: In the space below show length of screen below bottom of casing, diameter and kind of screen or casing perforation.
slotted 566-608
629-650

If a flowing well, flow of completed well: 30

Attach sheet if more space is needed

Silver King Mines, Inc.
Name of Drilling Contractor

(2) PUMP INSTALLATION

Company name and size of pump: HR

Type of pump: Capacity of installed pump:

Depth of pump placement: ft., Date of pump installation:

(3) WATER SURFACE MEASURING TUBE

On some wells an air-tight water surface measuring tube is required. See Section 45.408 of Chapter 45, MINNESOTA WELL CONSTRUCTION STANDARDS.

Show exact vertical length of water surface measuring tube, when installed: ft., tube material:

Name of Pump Installation Contractor:





1 of 1
Sull River

NOTICE OF WELL CONSTRUCTION

(1) WELL CONSTRUCTION

Location of well: NW 1/4 NW 1/4 Section 3 Township 7S Range 1E

Well owner Kathryn Spencer Dewey Route, Edgemont, SD 57735
(Name) (Address)

Date well drilling completed 10-22-80 Purpose of well Domestic
(domestic, irrigation, municipal, industrial, other)

WELL LOG

(Litho Log Footages)
Log to top of hole

Log Footages	Description of layer	Depth to top of water producing equifer	ft.
Ksc → 0-320	Dark gray shale	580	
Kfu → 320-395	Gray mudstone with 10% gray siltstone	flows	
395-445	Gray mudstone with 58-20% gray vfgss	Lakota	
Klf → 445-490	Green mudstone	Total depth of drill hole	625
490-520	AA w/10-30% G & GR Mt silt	Depth to bottom of casing	580
520-545	Gray fgss	Casing information: in the space below show kind, size, weight, lengths per diameter, etc., for production casing and surface casing, if used.	
545-560	well cemented vt - fgss	5 1/2" 14 lbs/ft.	
560-575	Gray mudstone with 10% dark brown mudstone	Random	twenties
575-590	AA with 10-20% gray vfgss	Screen information: in the space below show length of screen below bottom casing, diameter and kind of screen or casing perforations.	
590-615	Gray fine grain sandstone	45 ft. open hole	
615-620	Green mudstone with <5% gray vfgss		
620-625	Green mudstone with 50% brown-red mudstone		

Attach sheet if more space is needed

If a flowing well, flow of completed well 1.00 G.P.M.

Silver King Mines, Inc.
Name of Drilling Contractor

(2) PUMP INSTALLATION

Company name and size of pump _____ HP _____

Type of pump _____ Capacity of installed pump _____ G.P.M.

Depth of pump placement _____ ft., Date of pump installation _____

(3) WATER SURFACE MEASURING TUBE

On some wells an air-tight water surface measuring tube is required: See Section 46.40B of Chapter 46.4, MINIMUM WELL CONSTRUCTION STANDARDS.

Show exact vertical length of water surface measuring tube, when installed _____ ft., tube diameter _____, tube material _____

Name of Pump Installation Contractor



DRILLER'S FINAL REPORT

OFFICE OF STATE ENGINEER
Pierre, South Dakota

Well No. _____
(do not fill in)

CUSTER COUNTY

Location: SW NW Section 33 Twp. 6S Range 1E

Owner George Putnam Address Burdock, S. Dak.

Depth 494 Drawdown _____ Type Rig Used cable tool

Flow (gpm) _____ Pressure _____ Date Measured _____

Grd. Elev. _____ Water Level Below Ground Surface _____

Temperature _____ Character Water (soft, medium, hard)

Date Commenced _____ Date Completed 11/12/49

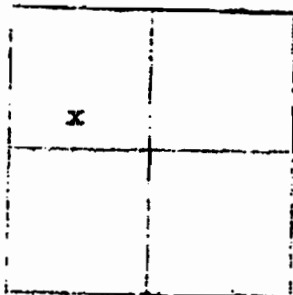

Section _____

CASING DETAIL

Type	Size	Length	Depth
	4"	497	494

PERFORATIONS

Type	Size	Length	Depth

SCREEN

Type	Size	Length	Depth

Is there a seal between different size pipes? What kind? _____

WATER BEARING SANDS

From _____ To _____

SOURCE OF INFORMATION

PMA office, Fall River Co.

DRILLER'S LOG

From	To

Banded Driller Roy Boneg (Signature)
Hot Springs, S. Dak.
Address _____

PLEASE COMPLETE
ENTIRE FORM

WELL DRILLERS REPORT
Division of Water Rights
Department of Water & Natural Resources

6/60

Well Owner:
Name Francis & Paul Jozwick
Address Casper, Wyoming

Well Location:

North

	+	
W	+	E
	+	

1 mile

County Custer
NW 1/4 SW 1/4 Sec. 30 Twp. 6S Rg. 1E

Water Level Information:
 Static water level _____ below land sur
 If flowing: closed in pressure 28 PSI
 rate of flow _____ GPI

Controlled by:
 Valve Reducers Other
 If other; specify _____

Well Test Data:
 Pumped Describe: _____
 Bailed Describe: _____
 Other Describe: _____

Pumping Level Below Land Surface

	ft. After _____	Hrs. pumped _____	
	_____	_____	_____
	_____	_____	_____

Proposed Use:
 Domestic Municipal Test Holes
 Irrigation Industrial Stock

Method of Drilling:
 Forward Rotary Bored Jetted
 Reverse Rotary Cable Other

Well Log:

Formation	Depth	
	From	To
	0	15
Med. & dk gry sh	15	400
Dk gry sh	400	535
Intbd gry slt & clst	535	547
Gry-vfgr ss & clst	547	602
Clst	602	610
Vf, fgrr ss tr clst	610	673
Gry clst	673	680

(Use Back if Necessary)

Well Construction:
 Diameter of Hole 7 7/8
 Depth 680
 Casing Steel Concrete
 Plastic Other
 If other, specify _____

Was casing end left open	Yes
Was a well screen installed	No

Describe Well Screen
 Diameter _____ Material _____
 Slot size _____

Was well gravel packed	No
Was well grouted	Yes
Was water sample taken	No

Date Completed: March 4, 1982

Driller: Contract Rig by
Silver King Mines, Inc. 406
 Driller's or Firm's Name License

Edgemont, SD 57735
 Address

Remarks: Cased w/14-5# 5 1/2" steel casing
Perforation completion.



Signed By _____ Date _____



SOUTH DAKOTA WELL REHABILITATION REPORT

11-02

Location SE 1/4 NW 1/4 Sec 5 Twp 7S Rg 1E

County

FALL RIVER

Please mark well location with an "X"

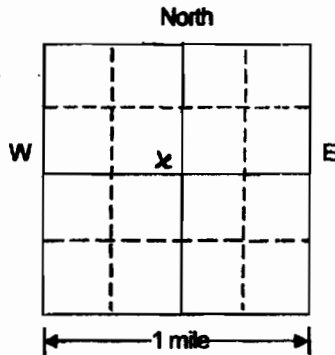

Well owner:

Name Putnam + Putnam, L.L.P.

Address 778 Cedar St.

City, State, Zip Dewey S.D. 57735-5011

Describe original construction if possible.
(Attach original log if available) DRILLED 1949
WELL DRILLED 580'
CASED 8" TO 220'
OPEN HOLED TO BOTTOM

Rehabilitation Completion Date 11-15-09

PROPOSED USE:

- Domestic
- Irrigation
- Municipal
- Industrial
- Stock

RECEIVED

JAN - 8 2010

WATER RIGHTS PROGRAM

Description of condition of well before rehabilitation:

CASING DETERIATING ABOVE AND BELOW GROUND

Description of rehabilitation work completed:

Swabbed Well For 310', Put 4" PVC casing Solid For 280' 30' of Screen
Put Shake Packer at 220' and Trimmey Line Pressure Grouted Back To Surface
Reduced casing To 1 1/2" and Put on Ball Valve To control Well.

Recasing information: Material P.V.C. Diameter 4 Inches Depth 300 Feet

Describe screen or perforations .25 Factory Slotted Screen Location From 280 To 300
From _____ To _____

Grout: YES Describe grouting procedure and grout
 NO

Put Trimmey Line To 220' to Shake Packer
Pressure 44 Bags Cement Back To Surface.

Well Test Data: Specific capacity _____ Static water level Flowing

If a flowing well GPM 75 Shut in 10 PSI

This well rehabilitation was completed under license # 724 and this report is true and accurate.

Drilling firm: J+M DRILLING

Signature of Licensed Representative: [Signature]

Signature of Well Owner: [Signature]

Date: 1-4-2010

1-5-10



STATE OF SOUTH DAKOTA WELL DRILLERS REPORT

115 Replacement

1 of 1

Location NW 1/4 SE 1/4 Sec 18 Twp 6 S Rg 1 E

County CUSTER

Please mark well location with an "X"

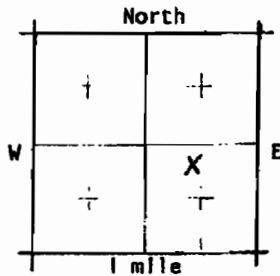

Well Completion Date Oct 2 1984

PROPOSED USE:

- Domestic
- Municipal
- Test Holes
- Irrigation
- Industrial
- Stock

Method of Drilling:

ROTARY MUD

WELL CONSTRUCTION: 6" to 280'

Diameter of hole 4" inches Depth 360 feet

Casing: Steel Plastic Other
Specify 6" VEUROD MINE 4" SCH 40

Pipe Weight	Diameter	From	To
<u>SCH 200</u> lb/ft	<u>6</u> inches	<u>0</u> feet	<u>280</u> feet
<u>SCH 40</u> lb/ft	<u>4"</u> inches	<u>160</u> feet	<u>360</u> feet

Was a well screen used? Yes No

If Not Specify _____

Screen Type 4" PVC Slot Size 1/64"

Length 80' Diameter 4"

Was Casing left open end? Yes No

Was a Packer or seal used? Yes No

If so what material? RUBBER

Was well gravel packed? Yes No

Was well grouted? Yes No

Describe grouting procedure PUMPED JS

BAG MIX DOWN INSIDE & UP OUTSIDE

To what depth? 180 Feet

What was grouting material? TYPE II

If cement, how many sacks? 25

Location of packer(s) and screen or perforated pipe 30 FT SCREEN 200-220 PACKER

280 SCREEN 300-360

WAS WELL PLUGGED OR ABANDONED? Yes No

If so how and with what material?

Well Owner:

Name BIL HOLLERBECK

Address Becky Rt Box 38 EDGE MOUNT S.D

Well Log: Depth 5775'

Formation	From	To
<u>SHALE</u>	<u>0</u>	<u>80</u>
<u>FALL RIVER</u>	<u>80</u>	<u>220</u>
<u>FUSON</u>	<u>220</u>	<u>240</u>
<u>LAROTA</u>	<u>240</u>	<u>360</u>

STATIC WATER LEVEL 0 Feet

If flowing: closed in pressure 6 LBS PSI

GPM flow 65 through 6" inch pipe

Controlled by Valve Reducers Other

If other; specify _____

Can well be completely shut off? YES

WELL TEST DATA:

- Pumped
- Bailed Describe: _____
- Other

Inyan Kara

Pumping Level Below Land Surface

ft. After	Hrs. pumped	GPM
_____	_____	_____
_____	_____	_____
_____	_____	_____

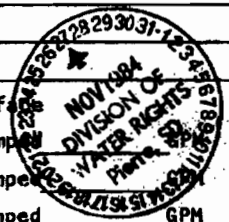

Remarks: THIS IS OFFSET TO OLD WELL THAT WAS LEAKING CEMENTED WELL SENT. PUMPED 13 BAGS IN AT 160 FT.

This well was drilled under license # 415

and this report is true and accurate.

Drilling Firm BAVY DRILLING Signed by Ronald P. Cook

Date Oct 18, 1984 Alte sent 12-6-84

HAM-4

PLEASE PRINT
ENTIRE FORM

WELL DRILLERS REPORT
Division of Water Rights
Department of Water & Natural Resources

1 of 1

6/60

Well Owner:
Name Tennessee Valley Authority
Address _____

Well Location: North

+

+

+

+

+

1 mile

County Custer
SW NE SW SE Sec. 17 Twp. 6S Rg. 1E

Water Level Information:
Static water level 34' below land surface
If flowing: closed in pressure _____ PSI
rate of flow _____ GPM
Controlled by:
 Valve Reducers Other
If other; specify _____

Well Test Data:
 Pumped _____
 Bailed Describe: _____
 Other _____
Pumping Level Below Land Surface
_____ ft. After _____ Hrs. pumped _____ GPM
_____ " " _____ " " _____ "
_____ " " _____ " " _____ "

Proposed Use:
 Domestic Municipal Test Holes
 Irrigation Industrial Stock

Method of Drilling:
 Forward Rotary Bored Jetted
 Reverse Rotary Cable Other

Well Construction:
Diameter of Hole 6 1/8
Depth 750
Casing Steel Concrete
 Plastic Other
If other, specify _____
Was casing end left open Yes
Was a well screen installed No
Describe Well Screen
Diameter _____ Material _____
Slot size _____
Was well gravel packed No
Was well grouted Yes
Was water sample taken No

Well Log:

Formation	Depth	
	From	To
Alluvium	0	33
Gry shale	33	403
Intbd gry sltst & sh	403	416
Intbd gry vfgar ss & clst	416	485
Br fgr ss	485	507
Gr & rd vfgarss & gry clst	507	550
Rd f, mgrss	550	576
Dr brn clst	576	585
Rd mgrss	585	596
Intbd gry, brn clst & gry sltst	596	651
lt ortn f, mgr ss	651	693
brn clst	693	695
O: f, m, cgr ss	695	742
gry clst	742	750

(Use Back if Necessary)

Date Completed: February 9, 1982

Driller:
Silver King Mines, Inc. 405
Driller's or Firm's Name License NO.
Edgemont, SD 57735
Address

Remarks: Cased w/.219 wall 4 1/2" steel casing.
Open hole completion.



Signed By _____ Date _____



Location SE 1/4 NE 1/4 Sec 19 Twp 6S Rg 1E

County CUSTER

Please mark well location with an "X"

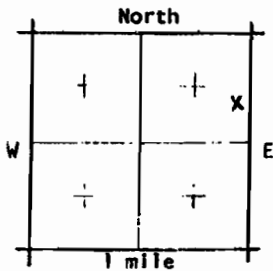

Well Completion Date OCT 16 1984

PROPOSED USE:
 Domestic Municipal Test Holes
 Irrigation Industrial Stock

Method of Drilling:

ROTARY MUD

WELL CONSTRUCTION: TO 520' TO 900'
Diameter of hole 6" inches Depth 4' feet

Casing: Steel Plastic Other
Specify 6" VELCOT MARK 4" SEA 46 SCISS

Pipe Weight Diameter From To
lb/ft 6" inches 0 feet 520 feet
lb/ft 4" inches 500 feet 900 feet

Was a well screen used? Yes No

If Not Specify _____

Screen Type RUC Slot Size 1/64
Length 60' Diameter 4"

Was Casing 1-ft open end? Yes No

Was a Packer or seal used? Yes No

If so what material? DURASEL

Was well gravel packed? Yes No

Was well grouted? Yes No

Describe grouting procedure PRESSURE GROUT
6" PIPE 0 TO 520

To what depth? 520 Feet
What was grouting material? TYPE II CEMENT
If cement, how many sacks? 100

Location of packer(s) and screen or perforated pipe PACKER 780 SCREEN 780
TO 700 + 840 - 880

WAS WELL PLUGGED OR ABANDONED? Yes No
If so how and with what material?

WNR-836 4/82

Well Owner: MORRICE SERVICE OPERATION
Name BERNARD & LOWHAM PARTNERS

Address BOX 567 CASPER WYO 82402

Well Log:	Depth	
	From	To
<u>SHALE</u>	<u>0</u>	<u>480</u>
<u>FALL RIVER</u>	<u>480</u>	<u>600</u>
<u>FUSON</u>	<u>600</u>	<u>740</u>
<u>LAKOTA</u>	<u>740</u>	<u>885</u>
<u>MARRIOTT</u>	<u>885</u>	<u>900</u>

STATIC WATER LEVEL 0 Feet
 If flowing: closed in pressure 2 PSI
 GPM flow 16 through 6" inch pipe
 Controlled by Valve Reducers Other
 If other; specify _____
 Can well be completely shut off? YES

WELL TEST DATA:
 Pumped Injan Kara
 Bailed Describe: _____
 Other _____

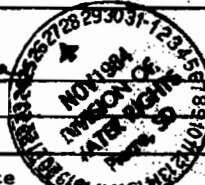

Pumping Level Below Land Surface
 _____ ft. After _____ Hrs. pumped _____ GPM
 _____ ft. After _____ Hrs. pumped _____ GPM
 _____ ft. After _____ Hrs. pumped _____ GPM

Remarks: NOTE THIS IS AN OFFSET TO OLD WELL, OLD WELL WAS CEMENTED AND PUMPED 16 BAGS CEMENT AT 200 FT.

This well was drilled under license # 415 and this report is true and accurate.

DRAY DRILLING Drilling Firm Quinn J. Dady Signed by

OCT 16 1984 Date Mr. Dady 12-6-84



Hydro ID 609

1 of 1

WELL CONSTRUCTION

Location of well SW 1/4 Rm 1/4 Sec 20 Township 6S Range 1E
 Well owner Tennessee Valley Authority, P. O. Box 49, Edgemont, South Dakota
 (Name) (Address)
 Date well drilling completed 6-26-78 Purpose of well Observation
 (domestic, irrigation, municipal, industrial, other)

WELL LOG

Layers, top to top in feet	Description of layer	Depth to top of water producing aquifer	840	ft.
0-20	Brown Soil	Depth to static water level		ft.
20-530	Gray Shale	Name of producing aquifer (if known)	Lakota	
530-545	Gray Sandstone	Total depth of drill hole	1000	ft.
545-620	Lt. Gray & Brown Mudstone & Siltstone	Depth to bottom of casing	966	ft.
620-690	Lt. Gray Sandstone	Casing information: in the space below show kind, size, weight, lengths per diameter, etc. for production casing and surface casing, if used.		
690-720	Dark Gray Shale w/Light Gray Siltstone	1" Scheduling 40 Black Iron		
720-740	Gray Sandstone			
740-770	1B Dark Gray Shale, Gray-Green Mudstone			
770-820	Gray Sandstone	Screen information: in the space below show length of screen below bottom of casing, diameter and kind of screen or casing perforations.		
820-840	Gray Shale			
840-955	1B AA & Yellow-Brown Siltstone-Sandstone	Torch Slotted 903-966		
955-975	Red & Yellow Sandstone			
975-1000	Green w/Variiegated Mudstone	if a flowing well, flow of completed well _____ G.P.M.		

Attach sheet if more space is needed

Silver King Mines, Inc.
Name of Drilling Contractor

(2) PUMP INSTALLATION

Company name and size of pump _____ HP
 Type of pump _____ Capacity of installed pump _____ G.P.M.
 Depth of pump placement _____ ft., Date of pump installation _____

(3) WATER SURFACE MEASURING TUBE

On some wells an air-tight water surface measuring tube is required: See Section 46.408 of Chapter 46.4, MINIMUM WELL CONSTRUCTION STANDARDS.

Show exact vertical length of water surface measuring tube, when installed _____ ft., tube diameter _____
 tube material _____

Name of Pump Installation Contractor





Hydro ID 610

*1-29-78
1-02
1-20
Heavy ground*

Section 21 Township 6 Range 1E
Well owner Tennessee Valley Authority, P.O. Box 49, Edgemont, South Dakota
(Name) (Address)
Date well drilling completed 6-27-78 Purpose of well Observation
(domestic, irrigation, municipal, industrial, other)

WELL LOG

Layers, top in top in feet	Description of layer	Depth to top of water-producing aquifer
0-20	Brown Sandy Soil	605 ft
20-540	Gray Shale	Depth to static water level _____ ft
540-605	Gray Siltstone	Name of producing aquifer (if known) <u>Fall River</u>
605-680	1B Gray Sandstone & Gray Shale	Total depth of drill hole <u>680</u> ft
		Depth to bottom of casing <u>672</u> ft
		Casing information in the space below show kind, size, weight, lengths per 6' diameter, etc., for production casing and surface casing, if used
		<u>1" Scheduling 40 Black Iron</u>
		Screen information in the space below show length of screen below bottom of casing, diameter and kind of screen or casing perforations.
		<u>Torch Slotted 630-672</u>
		If a flowing well, flow of completed well _____ G.P.M.
		<u>Silver King Mines, Inc.</u> Name of Drilling Contractor

*Block 12-10-38
1-29-78
1-20*

(2) PUMP INSTALLATION

Company name and size of pump _____ HP
Type of pump _____ Capacity of installed pump _____ G.P.M.
Depth of pump placement _____ ft, Date of pump installation _____

(3) WATER SURFACE MEASURING TUBE

On some wells an air-tight water surface measuring tube is required. See Section 46.40B of Chapter 46.4, MINIMUM WELL CONSTRUCTION STANDARDS.

Show exact vertical length of water surface measuring tube, when installed _____ ft, tube diameter _____
tube material _____

Name of Pump Installation Contractor





NOTICE OF WELL CONSTRUCTION

(1) WELL CONSTRUCTION

Location of well: SW 1/4 NW 1/4 NE Section 29 Township 6S Range 1E
 Well owner: Tennessee Valley Authority, P.O. Box 49, Edgemont, South Dakota
(Name) (Address)
 Date well drilling completed: 6-27-78 Purpose of well: Observation
(domestic, irrigation, municipal, industrial, other)

WELL LOG

Layers, top to top in feet	Description of layer	Depth to top of water producing aquifer _____ 605 _____ ft.
0-20	Brown Sandy Soil	Depth to static water level _____ ft.
20-540	Gray Shale	Name of producing aquifer (if known) Fall River
540-605	Gray Siltstone	Total depth of drill hole _____ 680 _____ ft.
605-680	18 Gray Sandstone & Gray Shale	Depth to bottom of casing _____ 672 _____ ft.
Casing information: In the space below show kind, size, weight, lengths per diameter, etc. for production casing and surface casing, if used.		
1" Scheduling 40 Black Iron		
Screen information: In the space below show length of screen below bottom of casing, diameter and kind of screen or casing perforations.		
Torch Slotted 630-672		
If a flowing well, flow of completed well _____ G.P.M.		

Attach sheet if more space is needed

Silver King Mines, Inc.
Name of Drilling Contractor

(2) PUMP INSTALLATION

Company name and size of pump _____ HP
 Type of pump _____ Capacity of installed pump _____ G.P.M.
 Depth of pump placement _____ ft., Date of pump installation _____

(5) WATER SURFACE MEASURING TUBE

On some wells an air-tight water surface measuring tube is required: See Section 46.40B of Chapter 46.4, MINIMUM WELL CONSTRUCTION STANDARDS.

Show exact vertical length of water surface measuring tube, when installed _____ ft., tube diameter _____, tube material _____

Name of Pump Installation Contractor





6-1-80

NOTICE OF WELL CONSTRUCTION

Trust
Custer

(1) WELL CONSTRUCTION

Location of well: SE 1/4 NE 1/4 Section 20 Township 65 Range 1E

Well owner: Tennessee Valley Authority (Name) (Address)

Date well drilling completed: 10-17-81 Purpose of well: Test (domestic, irrigation, municipal, industrial, other)

WELL LOG

Layers, top to top in feet	Description of layer	Depth to top of water producing aquifer	Depth to static water level	Name of producing aquifer (if known)	Total depth of drill hole	Depth to bottom of casing
0-440	Dk brn-gy shale	694	34.2	Lakota	815	694
440-500	Gy & brn mudstone					
500-520	Lt red sandstone					
520-565	Dk brn & gy-gn mdst					
565-600	Red sandstone					
600-625	Dk brn mdst-siltst		0-25' 20" steel			
625-645	Dk brn mdst		0-695 10 3/4" steel			
645-690	Gy & brn mdst w/int'd rd siltst		730-755 8 5/8" steel			
690-725	Red ss w/orng cht					
725-755	Red siltst					
755-800	Red ss w/wht, orng & gy chert pbl cgl					

Casing information: In the space below show kind, size, weight, length per diameter, etc., for production casing and surface casing, if used.

Screen information: In the space below show length of screen below bottom of casing, diameter and kind of screen or casing perforations.

If a flowing well, flow of completed well: NA

Attach sheet if more space is needed

Forward Drilling Company
Name of Drilling Contractor

(2) PUMP INSTALLATION

Company name and size of pump: Pioneer 6" HP 50
Type of pump: Submersible Capacity of installed pump: 325 G.P.M.
Depth of pump placement: 525 ft., Date of pump installation: 12-2-81

(3) WATER SURFACE MEASURING TUBE

On some wells an air-tight water surface measuring tube is required. See Section 46.408 of Chapter 46.6, MINNESOTA WELL CONSTRUCTION STANDARDS.
Show exact vertical length of water surface measuring tube, when installed: 525 ft., tube diameter: 3/4"
tube material: poly

Great West Pump, Inc.
Name of Pump Installation Contractor



Hydro ID 612

NOTICE OF WELL CONSTRUCTION

(1) WELL CONSTRUCTION

Custer

Location of well: SE 1/4 NE 1/4 Section 20 Township 65 Range 1E

Well owner: Tennessee Valley Authority (Name) (Address)

Date well drilling completed: 8-14-81 Purpose of well: Observation (domestic, irrigation, municipal, industrial, other)

WELL LOG

Layers, top to top in feet	Description of layer	Depth to top of water producing aquifer
0-425	Blk sh	692
425-495	1B gy clst & ss	26.6
495-505	Rd & brn ss	Name of producing aquifer (if known): Lakota
505-525	Gy clst	Total depth of drill hole: 800
525-530	Rd & orng -brn clst	Depth to bottom of casing: 692
530-545	Brn & rd-brn ss	Casing information: In the space below show kind, size, weight, length per diameter, etc., for production casing and surface casing, if used.
545-555	Gy & wht slitst w/fy-gn clst	4" blk Iron 10#/ft
555-585	Orng, rd & brn ss	Screen information: In the space below show length of screen below bottom of casing, diameter and kind of screen or casing perforations.
585-610	Gy-wht slitst w/gn clst	open hole 692-800
610-640	Tn-gy ss	If a flowing well, flow of completed well: NA
640-650	Gy clst & gy wht slitst	Name of Drilling Contractor: Silver King Mines, Inc.
650-700	Gy & gn clst	Name of Drilling Contractor: Silver King Mines, Inc.
700-730	Tn, orng & rd-brn ss	
730-745	1B Gy ss & slitst	
745-800	Tn-brn ss	

(2) PUMP INSTALLATION

Company name and size of pump: _____ HP
 Type of pump: _____ Capacity of installed pump: _____ G.P.M.
 Depth of pump placement: _____ ft., Date of pump installation: _____

(3) WATER SURFACE MEASURING TUBE

On some wells an air-tight water surface measuring tube is required. See Section 46.408 of Chapter 46.4 MINING WELL CONSTRUCTION STANDARDS.
 Show exact vertical length of water surface measuring tube, when installed: _____ ft., tube diameter: _____
 tube material: _____



Name of Pump Installation Contractor: _____



NOTICE OF WELL CONSTRUCTION

[Signature]
Custer

(1) WELL CONSTRUCTION

Location of well: SE 1/4 NE 1/4 Section 211 Township 65 Range 1E

Well owner: Tennessee Valley Authority
(Name) (Address)

Date well drilling completed: 8-14-81 Purpose of well: Observation
(domestic, irrigation, municipal, industrial, other)

WELL LOG

Layers, top to top in feet	Description of layer	Depth to top of water producing aquifer
0-430	Blk sh	504
430-510	1B gy clst & ss	26.2
510-600	Tn-gy & rd-brn ss w/ gy, gn & rd clst	580
		504

Casing information: In the space below show kind, size, weight, length and diameter, etc., for production casing and surface casing, if any.
4" blk iron 10#/ft

Screen information: In the space below show length of screen below bottom of casing, diameter and kind of screen or casing perforations.
open hole 504-580

If a flowing well, flow of completed well: NA

Attach sheet if more space is needed

Silver King Mines, Inc.
Name of Drilling Contractor

(2) PUMP INSTALLATION

Company name and size of pump: HR
Type of pump: Capacity of installed pump: 200
Depth of pump placement: ft., Date of pump installation:

(3) WATER SURFACE MEASURING TUBE

- On some wells an air-tight water surface measuring tube is required. See Section 48.408 of Chapter 48.4, MINNESOTA WELL CONSTRUCTION STANDARDS.
- Show exact vertical length of water surface measuring tube, when installed: ft., tube diameter: tube material:

Name of Pump Installation Contractor:





6.10.20

NOTICE OF WELL CONSTRUCTION

7.11.20
Custer

(1) WELL CONSTRUCTION

Location of well: SF 1/4 NE 1/4 Section 20 Township 6S Range R1

Well owner Tennessee Valley Authority
(Name) (Address)

Date well drilling completed 9-14-81 Purpose of well Observation
(domestic, irrigation, municipal, industrial, other)

WELL LOG

Layers, top to top in feet	Description of layer	Depth to top of water producing aquifer	ft.
0-440	Blk sh		609
440-505	18 gy clst & ss	Depth to static water level	32.2
505-565	Rd & yw-brn ss w/rd-brn & gy clst	Name of producing aquifer (if known)	Lakota
565-575	Rd-brn clst	Total depth of drill hole	620
575-600	Rd 7 rd-brn ss-siltst	Depth to bottom of casing	609
600-620	18 gy clst & ss	Casing information: in the space below show kind, size, weight, length per diameter, etc., for production casing and surface casing, if used.	
		4" blk iron 10#/ft	
		Screen information: in the space below show length of screen below bottom of casing, diameter and kind of screen or casing perforations.	
		open hole 609-620	
		If a flowing well, flow of completed well <u>NA</u> G.P.M.	

Attach sheet if more space is needed

Silver King Mines, Inc.
Name of Drilling Contractor

(2) PUMP INSTALLATION

Company name and size of pump _____ HP

Type of pump _____ Capacity of installed pump _____ G.P.M.

Depth of pump placement _____ ft., Date of pump installation _____

(3) WATER SURFACE MEASURING TUBE

-On some wells an air-tight water surface measuring tube is required. See Section 46.409 of Chapter 46.4, MINNESOTA WELL CONSTRUCTION STANDARDS.

-Show exact vertical length of water surface measuring tube, when installed _____ ft., tube diameter _____ tube material _____

Name of Pump Installation Contractor



2-1-01 of 1

NOTICE OF WELL CONSTRUCTION

1) WELL CONSTRUCTION

Custer

Location of well: SE 1/4 NE 1/4 Section 20 Township 6S Range 1E

Well owner: Tennessee Valley Authority
(Name) (Address)

Date well drilling completed: 8-13-81 Purpose of well: Observation
(domestic, irrigation, municipal, industrial, other)

WELL LOG

Layers, top to top in feet	Description of layer	Depth to top of water producing aquifer	
0-435	Bk sh	712	ft.
435-505	Intbd gy clst, ss	39.7	ft.
505-525	Lt tn & brn ss		
525-550	lB gy clst-ss		
550-590	lB rd brn & gy sltst & clst		
590-600	Rd & brn ss		
600-620	lB gy-gn & rd-brn sltst & clst		
620-645	Gy-wht sltst		
645-685	lB gy-wht sltst & pk sltst		
685-695	Pk & brn ss w/gy clst		
695-800	Brn, orng, tn, pk, rd & yw ss		

Depth to top of water producing aquifer: 712 ft.
 Depth to static water level: 39.7 ft.
 Name of producing aquifer (if known): Lakota
 Total depth of drill hole: 800 ft.
 Depth to bottom of casing: 712 ft.

Casing information: in the space below show kind, size, weight, length per diameter, etc., for production casing and surface casing, if used.

4" blk Iron 10#/ft

Screen information: in the space below show length of screen below bottom of casing, diameter and kind of screen or casing perforations.

open hole 712-800

If a flowing well, flow of completed well: NA gpm

Attach sheet if more space is needed

Silver King Mines, Inc.

Name of Drilling Contractor

2) PUMP INSTALLATION

Company name and size of pump: _____ HP

Type of pump: _____ Capacity of installed pump: _____ gpm

Depth of pump placement: _____ ft., Date of pump installation: _____

3) WATER SURFACE MEASURING TUBE

On some wells an air-tight water surface measuring tube is required. See Section 48.40B of Chapter 48A, Minnesota WELL CONSTRUCTION STANDARDS.

Show exact vertical length of water surface measuring tube, when installed: _____ ft., tube diameter: _____

tube material: _____

Name of Pump Installation Contractor





Hydro ID 616

1 of 1

NOTICE OF WELL CONSTRUCTION

Sub-River

CUSTER

1) WELL CONSTRUCTION

Location of well: SE 1/4 NE 1/4 Section 20 Township 6S Range R1

Well owner: Tennessee Valley Authority (Name) (Address)

Date well drilling completed: 9-15-81 Purpose of well: Observation (domestic, irrigation, municipal, industrial, other)

WELL LOG

Layers, top to top in feet	Description of layer	Depth to top of water producing aquifer
0-465	Blk sh	735 ft.
465-530	1B gy clst & ss	Depth to static water level: 45.8 ft.
530-550	Rd & yw-brn ss	Name of producing aquifer (if known): Lakota
550-605	1B gn sltst & gn-gy clst	Total depth of drill hole: 835 ft.
605-645	Gy clst w/gy-wht sltst	Depth to bottom of casing: 735 ft.
645-680	Gy ss	Casing information: In the space below show kind, size, weight, length and diameter, etc., for production casing and surface casing, if used. 4" blk iron 10#/ft
680-720	Gy w/gn clst	
720-760	1B rd & yw-brn ss, gy sltst & rd-brn & brngy clst	
760-835	Tn ss	Screen information: In the space below show length of screen below bottom of casing, diameter and kind of screen or casing perforations. open hole 735-835
		If a flowing well, flow of completed well: NA

Attach sheet if more space is needed

Silver King Mines, Inc.
Name of Drilling Contractor

2) PUMP INSTALLATION

Company name and size of pump: HR

Type of pump: Capacity of installed pump: G.P.M.

Depth of pump placement: ft., Date of pump installation:

3) WATER SURFACE MEASURING TUBE

On some wells an air-tight water surface measuring tube is required. See Section 48.408 of Chapter 48.4, MINNESOTA WELL CONSTRUCTION STANDARDS.

Show exact vertical length of water surface measuring tube, when installed: ft., tube diameter: tube material:

Name of Pump Installation Contractor





Hydro ID 617

6-1-20
1 of 1

NOTICE OF WELL CONSTRUCTION

Gold River Custer

(1) WELL CONSTRUCTION

Location of well: SW 1/4 NE 1/4 Section 20 Township 6S Range 1E

Well owner: Tennessee Valley Authority (Name) (Address)

Date well drilling completed: 9-15-81 Purpose of well: Observation (domestic, irrigation, municipal, industrial, other)

WELL LOG

Layers, top to top in feet	Description of layer	Depth to top of water producing aquifer
0-450	Blk sh	715
450-520	1B gy clst & ss	Depth to static water level: 21.4
520-555	Rd-brn & gy clst w/gy ss	Name of producing aquifer (if known): Lakota
555-570	Rd & brn ss	Total depth of drill hole: 810
570-625	1B gy sltst & gy, gn & rd clst	Depth to bottom of casing: 715
625-655	Gy ss	Casing information: In the space below show kind, size, weight, length per diameter, etc., for production casing and surface casing, if used.
655-740	1B gy slst w/gy-gn & brn clst	4" blk iron 10#/ft
740-810	Tn, yw & rd-brn ss	Screen information: In the space below show length of screen below bottom of casing, diameter and kind of screen or casing perforations.
		open hole 715-810
		If a flowing well, flow of completed well: NA

Attach sheet if more space is needed

Silver King Mines, Inc.

Name of Drilling Contractor

(2) PUMP INSTALLATION

Company name and size of pump: _____ HP

Type of pump: _____ Capacity of installed pump: _____ G.P.M.

Depth of pump placement: _____ ft., Date of pump installation: _____

(3) WATER SURFACE MEASURING TUBE

On some wells an air-tight water surface measuring tube is required. See Section 46.40B of Chapter 46, MINNESOTA WELL CONSTRUCTION STANDARDS.

Show exact vertical length of water surface measuring tube, when installed: _____ ft., Tube diameter: _____

Tube material: _____

Name of Pump Installation Contractor



NOTICE OF WELL CONSTRUCTION

(1) WELL CONSTRUCTION

Location of well: NE 1/4 NE 1/4 Section 20 Township 6S Range 1E

Well owner Tennessee Valley Authority
(Name) (Address)

Date well drilling completed 8-17-81 Purpose of well Observation
(domestic, irrigation, municipal, industrial, other)

WELL LOG

Layers, top to top in feet	Description of layer	Depth to top of water producing aquifer	
0-420	Blk sh	714	ft.
		49.7	ft.
420-490	1B gy clst & ss		
490-585	1B gy, pk & orgn slts & rd-brn & gn clst	780	ft.
585-615	Gy-gn & rd-brn clst	714	ft.
615-650	Gy-wht sltst	Casing information: In the space below show kind, size, weight, lengths per diameter, etc., for production casing and surface casing, if used.	
650-690	Gy & gn clst	4" blk iron 10#/ft	
690-735	Gy w/rd & ywbrn ss w/brn-gy clst		
735-778+	Tn & yw-brn ss		
		Screen information: In the space below show length of screen below bottom of casing, diameter and kind of screen or casing perforations.	
		open hole 714-780	
		If a flowing well, flow of completed well <u>NA</u> G.P.M.	

Attach sheet if more space is needed

Silver King Mines, Inc.
Name of Drilling Contractor

(2) PUMP INSTALLATION

Company name and size of pump _____ HP _____

Type of pump _____ Capacity of installed pump _____ G.P.M.

Depth of pump placement _____ ft., Date of pump installation _____

(3) WATER SURFACE MEASURING TUBE

On some wells an air-tight water surface measuring tube is required. See Section 46.40B of Chapter 46.4, MINIMUM WELL CONSTRUCTION STANDARDS.

Show exact vertical length of water surface measuring tube, when installed _____ ft., tube diameter _____, tube material _____.

Name of Pump Installation Contractor



Control

NOTICE OF WELL CONSTRUCTION

(1) WELL CONSTRUCTION

Location of well: NE 1/4 NE 1/4 Section 20 Township 6S Range R1

Well owner: Tennessee Valley Authority
(Name) (Address)

Date well drilling completed: 8-17-81 Purpose of well: Observation
(domestic, irrigation, municipal, industrial, other)

WELL LOG

Layers, top to top in feet	Description of layer	Depth to top of water producing aquifer	
0-420	Blk sh	503	ft.
		34.7	ft.
420-500	1B gy clst & ss	Name of producing aquifer (if known): <u>Fall River</u>	
500-580	Gy. rd & tn ss w/gy & brn clst	580	ft.
		503	ft.
		Casing information: In the space below show kind, size, weight, lengths per diameter, etc., for production casing and surface casing, if used.	
		4" blk iron 10#/ft	
		Screen information: In the space below show length of screen below bottom of casing, diameter and kind of screen or casing perforations.	
		open hole 503-580	
		If a flowing well, flow of completed well <u>NA</u> G.P.M.	

Attach sheet if more space is needed

Silver King Mines, Inc.
Name of Drilling Contractor

(2) PUMP INSTALLATION

Company name and size of pump _____ HP _____

Type of pump _____ Capacity of installed pump _____ G.P.M.

Depth of pump placement _____ ft., Date of pump installation _____

(3) WATER SURFACE MEASURING TUBE

On some wells an air-tight water surface measuring tube is required: See Section 46.408 of Chapter 46.4, MINIMUM WELL CONSTRUCTION STANDARDS.

Show exact vertical length of water surface measuring tube, when installed _____ ft., tube diameter _____, tube material _____

Name of Pump Installation Contractor



Hydro ID 623

6. 1 of 1 20

NOTICE OF WELL CONSTRUCTION

Fall River
Custer

(1) WELL CONSTRUCTION

Location of well: NE 1/4 NE 1/4 Section 2 Township 65 Range R1

Well owner: Tennessee Valley Authority (Name) (Address)

Date well drilling completed: 8-17-81 Purpose of well: Observation (domestic, irrigation, municipal, industrial, other)

WELL LOG

Layers, top to top in feet	Description of layer	Depth to top of water producing aquifer	ft.
0-420	Blk sh	503	ft.
420-500	IB gy clst & ss	34.2	ft.
500-580	Gy, rd & tn ss w/gy & brn clst	Fall River	ft.
		580	ft.
		503	ft.

Casing information: In the space below show kind, size, weight, length per diameter, etc., for production casing and surface casing, if used.

4" blk iron 108/ft

Screen information: In the space below show length of screen below bottom of casing, diameter and kind of screen or casing perforations.

open hole 503-580

If a flowing well, flow of completed well: NA G.P.M.

Attach sheet if more space is needed

Silver King Mines, Inc.
Name of Drilling Contractor

(2) PUMP INSTALLATION

Company name and size of pump: HR
Type of pump: Capacity of installed pump: G.P.M.
Depth of pump placement: ft., Date of pump installation:

(3) WATER SURFACE MEASURING TUBE

On some wells an air-tight water surface measuring tube is required. See Section 46.409 of Chapter 46.4, MINIMUM WELL CONSTRUCTION STANDARDS.
Show exact vertical length of water surface measuring tube, when installed: ft., tube diameter:
tube material:

Name of Pump Installation Contractor



Hydro ID 624

NOTICE OF WELL CONSTRUCTION

6-1-81 of 1

Custer

1) WELL CONSTRUCTION

Location of well: SE 1/4 NE 1/4 Section 18 Township 6S Range 1E

Well owner: Earl Darrow (Name) Edgemont, SD (Address)

Date well drilling completed: 7-30-81 Purpose of well: Domestic (domestic, irrigation, municipal, industrial, other)

WELL LOG

Layers, top to top in feet	Description of layer
0-20	Wh brn & gy clst and sltst
20-25	Gy clst & ywtn bent
25-35	Gy clst & ss
35-55	Gy clst
55-60	Gy ss
60-65	Brn & gy clst
65-70	Gy ss
70-95	Gy, blk, rd & orgn-brn clst
95-115	Rd, orgn-brn & ppl ss
115-120	Gy clst w/ss

Depth to top of water producing aquifer: 90 ft
 Depth to static water level: 0 ft
 Name of producing aquifer (if known): Fall River
 Total depth of drill hole: 120 ft
 Depth to bottom of casing: 120 ft

Casing information: In the space below show kind, size, weight, length per diameter, etc., for production casing and surface casing, if good.

160# 4" PVC

Screen information: In the space below show length of screen below bottom of casing, diameter and kind of screen or casing perforation.

slotted casing 90-115

If a flowing well, flow of completed well: 0.2 g.p.m.

Silver King Mines, Inc.
 Name of Drilling Contractor

2) PUMP INSTALLATION

Company name and size of pump: _____ HP _____
 Type of pump: _____ Capacity of installed pump: _____ G.P.M.
 Depth of pump placement: _____ ft., Date of pump installation: _____

3) WATER SURFACE MEASURING TUBE

On some wells an air-tight water surface measuring tube is required. See Section 46,408 of Chapter 48A, MINNESOTA WELL CONSTRUCTION STANDARDS.

Show exact vertical length of water surface measuring tube, when installed: _____ ft., tube diameter: _____ tube material: _____

Name of Pump Installation Contractor





SOUTH DAKOTA WATER WELL COMPLETION REPORT

Location SW 1/4 SW 23 Twp 65 Rg 1E
 County Custer
 Please mark well location with an "X"
 Well Completion Date Feb 98
 1 Mile

Well Owner: Alvin & John Putnam
 Business Name: Putnam & Putnam
 Address: 41C 59 Box 22 Edgemont SD 57135

WELL LOG:

FORMATION	DEPTH	
	FROM	TO
<u>Sand & Gravel</u>	<u>0</u>	<u>75</u>
<u>Shale</u>	<u>75</u>	<u>80</u>

LOCATION:
 Distance from nearest potential pollution source (septic tank, abandoned well, feed lot, etc.)? 150 ft. from septic tank (identify source).

PROPOSED USE: NONE
 Domestic/Stock Municipal Business Test Holes
 Irrigation Industrial Institutional Monitoring well

METHOD OF DRILLING:
Air Rotary

CASING DATA: Steel Plastic Other
 If other describe _____
 PIPEWEIGHT 15.5 LB/FT DIAMETER 5 IN FROM 0 FT TO 70 FT HOLE DIAMETER 7 7/8 IN

STATIC WATER LEVEL 20 Feet
 If flowing: closed in pressure _____ PSI
 GPM flow _____ through _____ inch pipe
 Controlled by Valve Reducers Other _____
 Reduced Flowrate _____ GPM
 Can well be completely shut in? _____

GROUTING DATA
 Grout Type Cement No. of Sacks 5 Grout Weight Legal lb./gal From 0 ft. 30 ft.
 Describe grouting procedure pumped

WELL TEST DATA:
 Pumped Describe: Air Lift
 Bailed 1.5 - 2.0 gpm
 Other _____
 Pumping Level Below Land Surface _____ ft. After _____ Hrs. pumped _____ GPM

SCREEN: Perforated pipe Manufactured
 Diameter 5 IN Length 40 FEET
 Material Steel
 Slot Size 1/16 Set From 30 Feet to 70 Feet
 Other information _____

WAS A PACKER OR SEAL USED? YES NO
 If so, what material? Rubber packer @ 30ft
 Describe packer(s) and location? _____

DISINFECTION: Was well disinfected upon completion? YES, How: Chlorinator

REMARKS



This well was drilled under license # 603
 And this report is true and accurate.
 Drilling firm Lipsett Drilling
 Signature of Licensed Representative: Carl Lipsett
 Signature of Well Owner or Equitable Property Holder: Putnam & Putnam Partnership by John A. Putnam
 Date: 01.22.99

Laboratory sent to for water quality analysis



NOTICE OF WELL CONSTRUCTION

700 ft

WELL CONSTRUCTION

CUSTER

Location of well: NW 1/4 NE 1/4 Section 20 Township 6S Range 1E

Well owner: Tennessee Valley Authority (Name) (Address)

Date well drilling completed: 8-18-81 Purpose of well: Observation (domestic, irrigation, municipal, industrial, other)

WELL LOG

Layers, top to top in feet	Description of layer	Depth to top of water producing aquifer	Depth to static water level	Name of producing aquifer (if known)	Total depth of drill hole	Depth to bottom of casing
0-430	Blk sh	715	42.4	Lakota	800	715
430-500	lb gy clst & ss					
500-550	Gy & rd-brn ss					
550-580	Gy wht sltst w/gy-gn clst					
580-595	rd, orng & yw-brn & gy ss					
595-605	Gy wht sltst & gy-gn clst					
605-660	Gy ss w/gy sltst & gn clst					
660-690	Gy wht sltst & gn clst					
690-700	Gy w/orng ss					
700-745	lb brn & gy tr yw ss brn & gy clst					
745-800	Brn-gy & rd ss					

Casing information: In the space below show kind, size, weight, length per diameter, etc., for production casing and surface casing, if used.

4" blk iron 100/ft

Screen information: In the space below show length of screen below bottom of casing, diameter and kind of screen or casing perforations.

open hole 715-800

If a flowing well, flow of completed well: NA g.p.m.

Attach sheet if more space is needed

Silver King Mines, Inc.
Name of Drilling Contractor

(2) PUMP INSTALLATION

Company name and size of pump: HR

Type of pump: Capacity of installed pump: g.p.m.

Depth of pump placement: ft., Date of pump installation:

(3) WATER SURFACE MEASURING TUBE

On some wells an air-tight water surface measuring tube is required. See Section 46.408 of Chapter 46A, MINNESOTA WELL CONSTRUCTION STANDARDS.

Show exact vertical length of water surface measuring tube, when installed: ft., tube diameter: tube material:



Name of Pump Installation Contractor



MINIMUM WELL CONSTRUCTION STANDARDS

Well Owner Tennessee Valley Authority, P. O. Box 49, Federal, South Dakota (Name) (Address)

Date well drilling completed 1-26-78 Purpose of well Test (domestic, irrigation, municipal, industrial, other)

WELL LOG

Table with columns: Layers, top to bottom (feet), Description of layer, Depth to top of water producing aquifer, Depth to static water level, Name of producing aquifer (if known), Total depth of drill hole, and Depth to bottom of casing. Includes handwritten notes like 'Surface' and 'Torch Slotted'.

Attach sheet if more space is needed

Silver King Mines, Inc. Name of Drilling Contractor

(2) PUMP INSTALLATION

Company name and size of pump HP Type of pump Capacity of installed pump G.P.M. Depth of pump placement ft., Date of pump installation

(3) WATER SURFACE MEASURING TUBE

On some wells an air-tight water surface measuring tube is required: See Section 46.408 of Chapter 46.4, MINIMUM WELL CONSTRUCTION STANDARDS.

Show exact vertical length of water surface measuring tube, when installed ft., tube diameter, tube material

Name of Pump Installation Contractor





NOTICE OF WELL CONSTRUCTION

Well No. _____ Section _____ Range _____
 Well Name: Tennessee Valley Authority, P. O. Box 49, Edgemont, South Dakota
 (Name) (Address)
 Date well drilling completed: 11-7-79 Purpose of well: Observation
 (domestic, irrigation, municipal, industrial, other)

WELL LOG

Layers, top to low in feet	Description of layer	Depth to top of water producing aquifer	ft.
0-20	Weathered Brown Clay and Silt	504	
20-250	Dark Gray Shale		
250-375	Interbedded Gray Claystone and Lt. Gray Sandstone	550	
375-410	Dark Gray Claystone	504	
410-505	Lt. Gray-White Siltstone and Green Claystone		
505-550	Red-Brown Sandstone and Gray Mudstone		

Additional information in the space below show kind, size, weight, length per diameter, etc. for production casing and surface casing, if used.
4 1/2" Scheduling 40 Black Iron

Screen information in the space below show length of screen below bottom of casing, diameter and kind of screen or casing perforations.
Open Hole 504-550

If a flowing well, flow of completed well est. 40 G.P.M.

Attach sheet if more space is needed

Silver King Mines, Inc.
Name of Drilling Contractor

(2) PUMP INSTALLATION

Company name and size of pump _____ HP
 Type of pump _____ Capacity of installed pump _____ G.P.M.
 Depth of pump placement _____ ft., Date of pump installation _____

(3) WATER SURFACE MEASURING TUBE

On some wells an air-tight water surface measuring tube is required: See Section 46.408 of Chapter 46.4, MINIMUM WELL CONSTRUCTION STANDARDS.

Show exact vertical length of water surface measuring tube, when installed _____ ft., tube diameter _____, tube material _____

Name of Pump Installation Contractor





NOTICE OF WELL CONSTRUCTION

County _____ Range _____
 Date _____
 Name: Tennessee Valley Authority, P. O. Box 49, Edgemont, South Dakota
 (Name) (Address)
 Date well drilling completed: 11-7-78 Purpose of well: Observation
 (domestic, irrigation, municipal, industrial, other)

WELL LOG

Layers, top to bottom feet	Description of layer	Depth to top of water producing aquifer _____ 315 _____ ft.
0-20	Weathered Brown Clay and Silt	Depth to static water level _____ ft.
20-250	Dark Gray Shale	Name of producing aquifer (if known) <u>Fall River</u>
250-360	Gray Sandstone w/Lt. Med. Gray Claystone & Lt. Gray Siltstone	Total depth of drill hole <u>360</u> ft.
		Depth to bottom of casing <u>315</u> ft.
		Casing information in the space below show kind, size, weight, lengths per diameter, etc. for production casing and surface casing, if used.
		<u>4 1/2" Scheduling 40 Black Iron</u>
		Screen information: in the space below show length of screen below bottom of casing, diameter and kind of screen or casing perforations.
		<u>Open Hole 315-360</u>
		If a flowing well, flow of completed well <u>est. 2</u> G.P.M.

Attach sheet if more space is needed

Silver King Mines, Inc.
Name of Drilling Contractor

(2) PUMP INSTALLATION

Company name and size of pump _____ HP _____
 Type of pump _____ Capacity of installed pump _____ G.P.M. _____
 Depth of pump placement _____ ft., Date of pump installation _____

(3) WATER SURFACE MEASURING TUBE

On some wells an air-tight water surface measuring tube is required: See Section 46.408 of Chapter 46.4, MINIMUM WELL CONSTRUCTION STANDARDS.

Show exact vertical length of water surface measuring tube, when installed _____ ft., tube diameter _____
 tube material _____

Name of Pump Installation Contractor

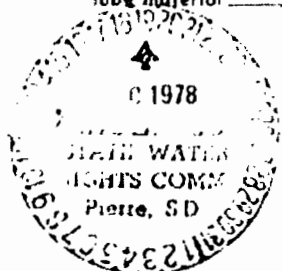



Hydro ID 668

7-1-50
Fall River 1977
1 of 2
3620319
dark sand

NOTICE OF WELL CONSTRUCTION

(1) WELL CONSTRUCTION

Location of well 1/4 NE 1/4 Section 15 Township 7S Range 1E

Well owner Tennessee Valley Authority - Box 49 - Edgemont, South Dakota
(Name) (Address)

Date well drilling completed 1-31-77 Purpose of well Test, Dewatering
(domestic, irrigation, municipal, industrial, other)

WELL LOG

Layers, top to top in feet	Description of layer	Depth to top of water producing aquifer	ft.
0 - 15	Alluvium & brn sh	280, 480	
15 - 240	Dk gy fissile sh	Flowing	
240 - 340	Dk gy sh, md gy clst	Name of producing aquifer (if known)	Fall River, Lakota
340 - 365	Md gy-gn clst	Total depth of drill hole	574
365 - 420	Wh-lt gy sltst-vfgrss	Depth to bottom of casing	480
420 - 445	Lt gn & gy clst	Casing information: In the space below show kind, size, weight, length per diameter, etc., for production casing and surface casing, if used.	
445 - 475	AA w/tr lt gy & brn vf-fgrss	Schedule 40 Blk Iron 10" diameter	
475 - 485	Gy fgrss	0 - 280	
485 - 500	AA w/brn mdst	335 - 480	
500 - 560	Pk & org calc cem vfgrss	Screen information: In the space below show length of screen below bottom casing, diameter and kind of screen or casing perforations.	
560 - 574	Lt-dk gy mdst	Johnson Well Screen Stainless Steel .030 slot size	
		10" diam 280 - 335	
		8" diam 480 - 555	
		If a flowing well, flow of completed well <u>35</u> G.P.M.	

Attach sheet if more space is needed

Forward Drilling Co.
Name of Drilling Contractor

(2) PUMP INSTALLATION

Company name and size of pump Pioneer # P 300 34T 6" HP 50

Type of pump submersible Capacity of installed pump 300 G.P.M.

Depth of pump placement 455 ft, Date of pump installation Feb. 10, 1977

(3) WATER SURFACE MEASURING TUBE

On some wells an air-tight water surface measuring tube is required: See Section 46 408 of Chapter 46.4, MINIMUM WELL CONSTRUCTION STANDARDS.

Show exact vertical length of water surface measuring tube, when installed _____ ft, tube diameter _____

tube material _____

*Lead w/ink
I used the size / X 24 pack
from used by for this one
The description was for
please contact the
library to see if
to return*

Forward Drilling Co.
Name of Pump Installation Contractor

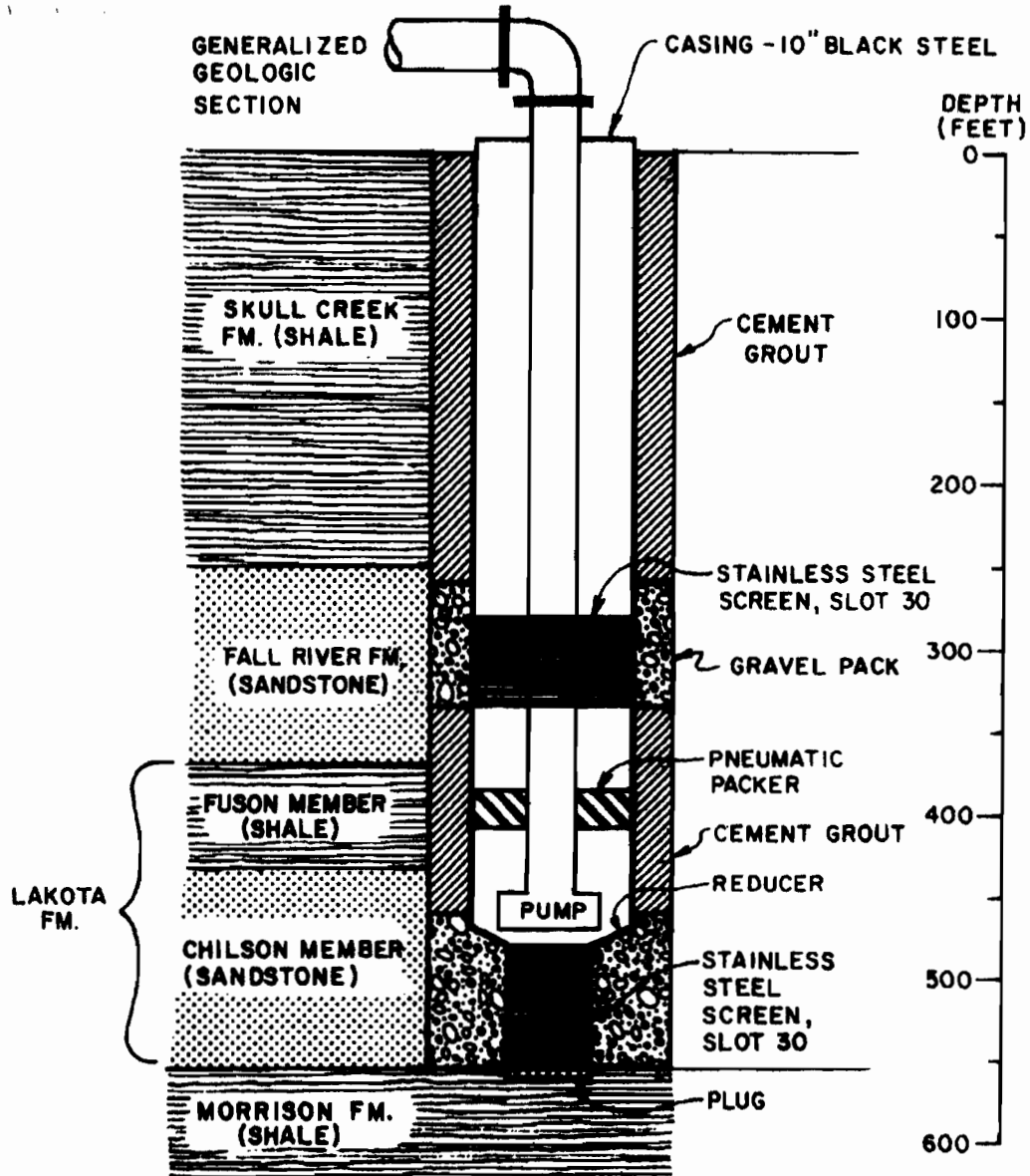

Source: Analysis of Aquifer Tests Conducted at the Proposed Burdock Uranium Mine Site, Burdock, South Dakota, WR-28-1-520-109, TVA, Boggs and Jenkins, May 1980.

Figure 2 : Burdock Well Profile



NOTICE OF WELL CONSTRUCTION

Well No. _____ Township _____ Range _____
 Well Owner Tennessee Valley Authority, P. O. Box 49, Edgemont, South Dakota
 (Name) (Address)
 Date well drilling completed 10-25-78 Purpose of well Observation
 (domestic, irrigation, municipal, industrial, other)

WELL LOG

Layers, top to top in feet	Description of layer	Depth to top of water producing aquifer	ft.
0-25	Brown Weathered Shale	510	ft.
25-235	Gray Shale		ft.
235-265	AA with Lt. Gray Sandstone & Siltstone	550	ft.
265-335	Brown Mudstone with Gray Sandstone & Gray-Green Mudstone	510	ft.
335-355	Gray Shale & Sandstone Siltstone		
355-370	Tan-Gray Siltstone		
370-390	Gray & Green Shale	4 1/2" Black Iron	Schedule 40
390-405	Dark Brown Mudstone		
405-440	Lt. Green Claystone-Siltstone		
440-475	White Siltstone, Sandstone		
475-485	Green Mudstone		
485-495	Tan Mudstone-Siltstone	Open Hole	510-550
495-510	Gray Sandstone, Brown Mudstone		
510-550	Red-Brown SS		

Attach sheet if more space is needed

Casing information in the space below show kind, size, weight, lengths per diameter, etc. for production casing and surface casing, if used.

Screen information: In the space below show length of screen below bottom casing, diameter and kind of screen or casing perforations.

If a flowing well, flow of completed well est. 35 G.P.M.

Silver King Mines, Inc.
 Name of Drilling Contractor

(2) PUMP INSTALLATION

Company name and size of pump _____ HP
 Type of pump _____ Capacity of installed pump _____ G.P.M.
 Depth of pump placement _____ ft., Date of pump installation _____

(3) WATER SURFACE MEASURING TUBE

On some wells an air-tight water surface measuring tube is required: See Section 46.408 of Chapter 46.4, MINIMUM WELL CONSTRUCTION STANDARDS.

Show exact vertical length of water surface measuring tube, when installed _____ ft., tube diameter _____
 tube material _____

 Name of Pump Installation Contractor



Hydro ID 670

1 of 1

NOTICE OF WELL CONSTRUCTION

FILED

County _____ Township _____ Range 1E
 Well owner Tennessee Valley Authority, P. O. Box 49, Edgemont, South Dakota
 (Name) (Address)
 Date well drilling completed 10-19-78 Purpose of well Observation
 (domestic, irrigation, municipal, industrial, other)

WELL LOG

Layers, top to top in feet	Description of layer	Depth to top of water producing aquifer	ft.
0-20	Weathered Brown Clay & Silt	377	ft.
20-250	Dark Gray Shale	Depth to static water level _____	ft.
250-260	Interbedded Gray Clay-stone & Lt. Gray Sandstone	Name of producing aquifer (if known) <u>Lakota-Fuson</u>	
260-355	Gray Clay Stone	Total depth of drill hole <u>395</u>	ft.
355-375	Lt. Gray-White Siltstone	Depth to bottom of casing <u>377</u>	ft.
375-390	Gray & Green Shale	Casing information in the space below show kind, size, weight, lengths per diameter, etc. for production casing and surface casing, if used.	
390-395	Dark Brown Mudstone	<u>4 1/2" Scheduling 40 Black Iron</u>	
Screen information in the space below show length of screen below bottom of casing, diameter and kind of screen or casing perforations.			
Open Hole <u>377-395</u>			
If a flowing well, flow of completed well <u>< 1</u> G.P.M.			

Attach sheet if more space is needed

Silver King Mines, Inc.
 Name of Drilling Contractor

(2) PUMP INSTALLATION

Company name and size of pump _____ HP _____
 Type of pump _____ Capacity of installed pump _____ G.P.M.
 Depth of pump placement _____ ft., Date of pump installation _____

(3) WATER SURFACE MEASURING TUBE

On some wells an air-tight water surface measuring tube is required: See Section 46.408 of Chapter 46.4, MINIMUM WELL CONSTRUCTION STANDARDS.

Show exact vertical length of water surface measuring tube, when installed _____ ft., tube diameter _____
 tube material _____

 Name of Pump Installation Contractor





NOTICE OF WELL CONSTRUCTION

FILED

Name: Tennessee Valley Authority, P. O. Box 49, Edgemont, South Dakota
(Name) (Address)

Date well drilling completed: 10-18-78 Purpose of well: Observation
(date) (domestic, irrigation, municipal, industrial, other)

WELL LOG

Layers, top to bottom feet	Description of layer	Depth to top of water producing aquifer	Depth to static water level	Name of producing aquifer (if known)	True depth of drill hole	Depth to bottom of casing
0-10	Weathered Brown Clay & Silt	300'		Fall River	350	300'
10-250	Dark Gray Shale					
250-260	Interbedded Gray Claystone & Lt. Gray Sandstone					
260-295	Med. & Lt. Gray Claystone					
295-300	AA w/trace green & Red Brown Claystone					
300-335	Lt. Gray Sandstone, Medium & Lt. Gray Claystone					
335-350	Gray-Green Mudstone, Gray Shale & Sandstone					

Casing information: in the space below show kind, size, weight, lengths per diameter, etc., for production casing and surface casing, if used

Screen information: in the space below show length of screen below bottom of casing, diameter and kind of screen or casing perforations.

Open Hole 300-350

If a flowing well, flow of completed well est. 2 G.P.M.

Attach sheet if more space is needed

Silver King Mines, Inc.

Name of Drilling Contractor

(2) PUMP INSTALLATION

Company name and size of pump _____ HP
Type of pump _____ Capacity of installed pump _____ G.P.M.
Depth of pump placement _____ ft., Date of pump installation _____

(3) WATER SURFACE MEASURING TUBE

On some wells an air-tight water surface measuring tube is required! See Section 46.408 of Chapter 46.4, MINIMUM WELL CONSTRUCTION STANDARDS.

Show exact vertical length of water surface measuring tube, when installed _____ ft., tube diameter _____
tube material _____

Name of Pump Installation Contractor





NOTICE OF WELL CONSTRUCTION

County _____ Township _____ Range _____

Well owner Tennessee Valley Authority, P. O. Box 49, Edgemont, South Dakota
(Name) (Address)

Date well drilling completed 11-6-78 Purpose of well Observation
(domestic, irrigation, municipal, industrial, other)

WELL LOG

Layers, top to top in feet	Description of layer	Depth to top of water producing aquifer _____ ft.
0-260	Dark Gray Shale	Depth to static water level _____ ft.
260-280	Gray Shale & Sandstone	Name of producing aquifer (if known) <u>Lakota-Fuson</u>
280-350	Gray Sandstone-Siltstone	Total depth of drill hole <u>420</u> ft.
350-355	Dark Brown Shale	Depth to bottom of casing <u>400</u> ft.
355-395	Gray Shale & Sandstone	Casing information: In the space below show kind, size, weight, length per diameter, etc., for production casing and surface casing, if used.
395-420	Gray-Green Mudstone	
		<u>4 1/2" Scheduling 40 Black Iron</u>
		Screen information: In the space below show length of screen below bottom of casing, diameter and kind of screen or casing perforations.
		<u>Open Hole 400-420</u>
		If a flowing well, flow of completed well _____ G.P.M.

Attach sheet if more space is needed

Silver King Mines, Inc.
Name of Drilling Contractor

(2) PUMP INSTALLATION

Company name and size of pump _____ HP

Type of pump _____ Capacity of installed pump _____ G.P.M.

Depth of pump placement _____ ft., Date of pump installation _____

(3) WATER SURFACE MEASURING TUBE

On some wells an air-tight water surface measuring tube is required: See Section 46.408 of Chapter 46.4, MINIMUM WELL CONSTRUCTION STANDARDS.

Show exact vertical length of water surface measuring tube, when installed _____ ft., tube diameter _____

tube material _____

Name of Pump Installation Contractor





NOTICE OF WELL CONSTRUCTION

County _____ Township _____ Range _____
 Well owner Tennessee Valley Authority, P. O. Box 49, Edgemont, South Dakota
 (Name) (Address)
 Date well drilling completed 11-6-78 Purpose of well Observation
 (domestic, irrigation, municipal, industrial, other)

WELL LOG

Layers, top to top in feet	Description of layer	Depth to top of water producing aquifer _____ ft.
0-10	Orange-Brown Weathered Shale	525
10-270	Dark Gray-Black Shale	Depth to static water level _____ ft.
270-280	AA w/Lt. Gray Siltstone Sandstone	Name of producing aquifer (if known) <u>Lakota</u>
280-390	Interbedded Dark Gray Carb. mudstone, Gray & Tan Sandstone	Water depth of drill hole <u>570</u> ft.
390-430	Dark Brown Mudstone	Depth to bottom of casing <u>525</u> ft.
430-455	w/Green-Gray Claystone	Casing information: In the space below show kind, size, weight, length per diameter, etc., for production casing and surface casing, if used.
455-470	Green w/Brown & Gray Claystone	<u>4 1/2" Scheduling 40 Black Iron</u>
470-500	Dark Brown-Gray Mudstone, trace Green Claystone; Tan Sandstone	
500-525	Green Claystone w/White Lt. Tan Siltstone-Sandstone	
525-570	Gray-Brown Mudstone w/Tan Sandstone	Screen information: In the space below show length of screen below bottom of casing, diameter and kind of screen or casing perforations.
	Gray Sandstone w/Gray-Brown Mudstone	
		Open Hole 525-570
		If a flowing well, flow of completed well <u>est. 35</u> G.P.M.

Attach sheet if more space is needed

Silver King Mines, Inc.
Name of Drilling Contractor

(2) PUMP INSTALLATION

Company name and size of pump _____ HP
 Type of pump _____ Capacity of installed pump _____ G.P.M.
 Depth of pump placement _____ ft., Date of pump installation _____

(3) WATER SURFACE MEASURING TUBE

On some wells an air-tight water surface measuring tube is required! See Section 46.408 of Chapter 46.4, MINIMUM WELL CONSTRUCTION STANDARDS.

Show exact vertical length of water surface measuring tube, when installed _____ ft., tube diameter _____
 tube material _____

Name of Pump Installation Contractor





SOUTH DAKOTA WATER WELL COMPLETION REPORT

Location NE 1/4 SW 1/4 Sec 34 Twp 6S Rg 1E
County Custer

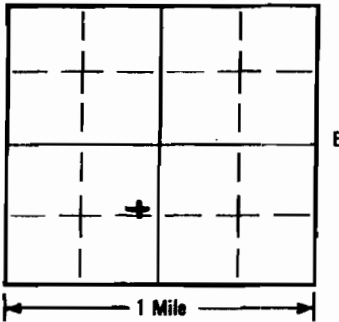

Please mark well location with an "X"
Long - 103.986774 W
Lat 43.481733
Well-Completion Date
9/26/2007

Well Owner: Powertech
Business Name: Same
Address: 145 N. Chicago Avenue, Suite C
Hot Springs, SD 57747

WELL LOG: TABLE WITH FORMATION, DEPTH (FROM, TO) columns. Includes a 'RECEIVED' stamp dated JAN 15 2008 and 'WATER RIGHTS PROGRAM' stamp.

LOCATION: Distance from nearest potential pollution source (septic tank, abandoned well, feed lot, etc.)? _____ ft. from _____ (identify source).

PROPOSED USE:
 Domestic/Stock Municipal Business Test Holes
 Irrigation Industrial Institutional Monitoring well

METHOD OF DRILLING:
4 1/4 ID. #SA

CASING DATA: Steel Plastic Other
If other describe PVC
PIPEWEIGHT DIAMETER FROM TO BELOW HOLE DIAMETER
____ LB/FT 2 IN 2 1/2 FT 12 1/2 FT 8 1/2 IN

GROUTING DATA
Grout Type No. of Sacks Grout Weight From To
____ lb./gal 1 ft 9 1/2 ft
Describe grouting procedure Tremie pipe

SCREEN: Perforated pipe Manufactured
Diameter 2 IN Length 10 FEET
Material PVC
Slot Size 0.010 Set From 12 1/2 Feet to 22 1/2 Feet

WAS A PACKER OR SEAL USED? YES NO
If so, what material? 2' Bentonite
Describe packer(s) and location? Above Sand Pack

DISINFECTION: Was well disinfected upon completion?
YES, How: _____
NO, Why Not? Not for human or domestic use

STATIC WATER LEVEL 17.65 Feet
If flowing: closed in pressure Not flowing PSI
GPM flow _____ through _____ inch pipe
Controlled by Valve Reducers Other
Reduced Flowrate _____ GPM
Can well be completely shut in? _____

WELL TEST DATA:
 Pumped Describe: Developed using a bailer
 Bailed Well did not bail down.
 Other
Pumping Level Below Land Surface
____ ft. After _____ Hrs. pumped _____ GPM
____ ft. After _____ Hrs. pumped _____ GPM
If pump installed, pump rate _____ GPM

REMARKS
Well Designation: DB-GW676

This well was drilled under license # 678
And this report is true and accurate.
Drilling firm American Engineering Testing, Inc.
Signature of License Representative: [Signature]
Signature of Well Owner or Equitable Property Holder: [Signature]
Date: 11/2/07



BORING/WELL CONSTRUCTION LOG

PROJECT NUMBER 18-02617 BORING/WELL NUMBER B-4/DB-GW676
 PROJECT NAME Dewey Burdock Monitor Well Installation DATE DRILLED 9/25/07
 LOCATION Burdock, South Dakota CASING TYPE/DIAMETER 2" ID Schedule 40 PVC
 DRILLING METHOD 4.25" ID HSA SCREEN TYPE 2" ID Schedule 40 PVC Slotted 0.010"
 SAMPLING METHOD Continuous PACKING TYPE #10-20 Silica Sand
 GROUND ELEVATION _____ GROUT TYPE Cement
 TOP OF CASING _____ DEPTH TO WATER 17.50
 LOGGED BY CH GROUND WATER ELEVATION _____
 REMARKS Well was completed with a 4" Pro Top

HNU (ppm)	Blow Count	RECOVERY (inches)	SAMPLER TYPE	INTERVAL	DEPTH (ft. BGL)	U.S.C.S.	GRAPHIC LOG	MATERIAL DESCRIPTION	GW LEVEL	BORING ABANDONED
			CSTS 1		1	CS		TOPSOIL with organics, dark brown, dry		Concrete
			CSTS 2		2			SANDY SILT, red, dry		
					3					
			CSTS 3		4					
					5					Cement Grout
					6					
					7					
			CSTS 4		8					
					9					
					10					Bentonite Seal
					11					
			CSTS 5		12					
					13			SILTY SANDY GRAVEL with cobbles, red to brown, dry to moist		
			CSTS 6		14			Same wet at 17.5 feet		
					15					
					16					
					17					
			CSTS 7		18					#10-20 Silica Sand Flush Threaded 2" PVC Screen 0.010" Slot
					19			Same saturated		
					20					
					21					
					22					
					23			End of Boring		Bottom of Well

AET-ENV1 18-02617 MW.GP-1 AET-ENV1.GDT 11/2/07



AMERICAN
ENGINEERING
TESTING, INC.

RECEIVED
JAN 15 2008
WATER RIGHTS
PROGRAM

CONSULTANTS
• GEOTECHNICAL
• MATERIALS
• ENVIRONMENTAL

January 11, 2008

Mr. Ken Buhler
Department of Environment and Natural Resources (DENR)
Water Rights Division
Joe Foss Building
523 East Capitol
Pierre, South Dakota 57501-3181

Subject: South Dakota Water Well Completion Reports
Wells Installed for Powertech
Burdock, South Dakota
AET No. 18-02617

Dear Mr. Buhler:

Enclosed please find the well completion reports for five groundwater monitoring wells, DB-GW675, DB-GW676, DB-GW677, DB-GW678 & DB-GW679. The wells were completed to obtain information on the potential shallow groundwater impacts from previous uranium mining within the project area prior to initiating new uranium production activities within the Dewey-Burdock, South Dakota area. If you have any questions or need any additional information please contact me at (605) 388-0029.

Sincerely,

Clarke L. Knigge, CPRR
Environmental Scientist
Project Manager

CLK

attachments

pc: Mr. Cory Foreman, RESPEC

Y:\wp8\Environmental\Correspondence\18-02617 MW Completion Report.wpd

This document shall not be reproduced, except in full, without written approval of American Engineering Testing, Inc.
1745 Samco Road • Rapid City, SD 57702 • 605-388-0029 • Fax 605-388-0064 • www.amengtest.com
Chanhassen • Duluth • Mankato • Marshall • Rochester • St. Paul, MN/Pierre • Rapid City • Sioux Falls, SD/La Crosse • Wausau, WI
AN AFFIRMATIVE ACTION AND EQUAL OPPORTUNITY EMPLOYER.

Hydro ID 676

NO. 11

JUL 17

B-4 DB - 6W 676

W/Organics
6" - TOP SOIL - DK BROWN DRY

TO 5' - SANDY SILT, RED, DRY

TO 10' - SILTY SAND, RED, DRY

SAME TO 13'

@ 13' - SANDY GRAVEL W/ COBBLES, RED TO BROWN, DRY TO MOIST

SAME TO 20'; WET @ 17.5'

Same to 27 1/2' Sat.

SOUTH DAKOTA WATER WELL COMPLETION REPORT

1 of 4 **07-92**

Location SW 1/4 SW 1/4 Sec 4 Twp 7S Rg 1E
 County Fall River
 North

Please mark well location with an "X"
 Long 104.0131
 Lat 43.464791
 Well-Completion Date
9/25/2007

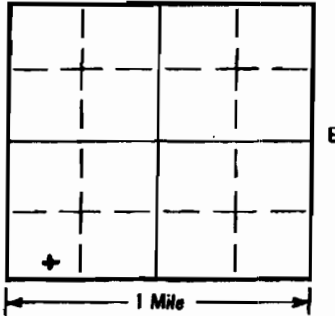

Well Owner: Powertech
 Business Name: Same
 Address: 145 N. Chicago Avenue, Suite C
Hot Springs, SD 57747

WELL LOG:	FORMATION	DEPTH	
		FROM	TO
<u>See Attached Boring Log</u>			
RECEIVED JAN 15 2008 WATER RIGHTS PROGRAM			

LOCATION:
 Distance from nearest potential pollution source (septic tank, abandoned well, feed lot, etc.)? _____ ft. from _____ (identify source).

PROPOSED USE:
 Domestic/Stock Municipal Business Test Holes
 Irrigation Industrial Institutional Monitoring well

METHOD OF DRILLING:
4 1/4 HSA

CASING DATA: Steel Plastic Other
 If other describe PVC

PIPEWEIGHT	DIAMETER	FROM	TO	HOLE DIAMETER
_____ LB/FT	<u>2</u> IN	<u>2 1/2</u> FT	<u>4</u> FT	<u>8 1/2</u> IN
_____ LB/FT	_____ IN	_____ FT	_____ FT	_____ IN
_____ LB/FT	_____ IN	_____ FT	_____ FT	_____ IN

GROUTING DATA

Grout Type	No. of Sacks	Grout Weight	From	To
_____	_____	_____ lb./gal	_____ ft	_____ ft
_____	_____	_____ lb./gal	_____ ft	_____ ft

 Describe grouting procedure Top 1' filled w/concrete

SCREEN: Perforated pipe Manufactured
 Diameter 2 IN Length 10 FEET
 Material PVC
 Slot Size 0.010 Set From 4 Feet to 14 Feet
 Other information _____

WAS A PACKER OR SEAL USED? YES NO
 If so, what material? 2' Bentonite Plug
 Describe packer(s) and location? Above Sand Pack

DISINFECTION: Was well disinfected upon completion?
 YES, How: _____
 NO, Why Not? Not for Human or Domestic Animal use
 Laboratory sent to for water quality analysis _____

STATIC WATER LEVEL = 9 Feet
 If flowing: closed in pressure Not flowing PSI
 GPM flow _____ through _____ inch pipe
 Controlled by Valve Reducers Other _____
 Reduced Flowrate _____ GPM
 Can well be completely shut in? _____

WELL TEST DATA:
 Pumped Describe: Developed utilizing a bailer. Well did not bail down
 Bailed
 Other
 Pumping Level Below Land Surface
 _____ ft. After _____ Hrs. pumped _____ GPM
 _____ ft. After _____ Hrs. pumped _____ GPM
 If pump installed, pump rate _____ GPM

REMARKS
DB-6W677

This well was drilled under license # 678
 And this report is true and accurate.
 Drilling firm American Engineering Testing
 Signature of License Representative: _____
 Signature of Well Owner or Equitable Property Holder: _____
 Date: 11/2/07



POWERTECH (USA) INC.

A ENGINEERING
TESTING, INC.

BORING/WELL CONSTRUCTION LOG

PROJECT NUMBER	18-02617	BORING/WELL NUMBER	B-2/DB-GW677
PROJECT NAME	Dewey Burdock Monitor Well Installation	DATE DRILLED	9/25/07
LOCATION	Burdock, South Dakota	CASING TYPE/DIAMETER	2" ID Schedule 40 PVC
DRILLING METHOD	4.25" ID HSA	SCREEN TYPE	2" ID Schedule 40 PVC Slotted 0.010"
SAMPLING METHOD	Continuous	PACKING TYPE	#10-20 Silica Sand
GROUND ELEVATION		GROUT TYPE	Cement
TOP OF CASING		DEPTH TO WATER	9.00
LOGGED BY	CH	GROUND WATER ELEVATION	
REMARKS	Well was completed with a 4" Pro Top		

HNU (ppm)	Blow Count	RECOVERY (Inches)	SAMPLER TYPE	INTERVAL	DEPTH (ft. BGL)	U.S.C.S.	GRAPHIC LOG	MATERIAL DESCRIPTION	GW LEVEL
			CSTS 1	1-2	1	CL		SANDY SILT, medium grain, tan	Concrete
				2-3	2				
			CSTS 2	4-5	4			SANDY SILT	Bentonite Seal
				5-6	5				
			CSTS 3	6-7	6			SILTY SAND, poorly sorted	#10-20 Silica Sand Flush Threaded 2" PVC Screen 0.010" Slot
			CSTS 4	7-8	7			SILTY SAND, tan	
			CSTS 5	8-9	8			SAND, very fine grained, tan, wet	
			CSTS 6	13-14	9			SHALE (Belle Fourche), dark gray, fissile	
					10				Bottom of Well

AET_EMI_18-02617.MMI.GPJ_AET_EMI.GDT_11/2007



**AMERICAN
ENGINEERING
TESTING, INC.**

**RECEIVED
JAN 15 2008
WATER RIGHTS
PROGRAM**

CONSULTANTS
• GEOTECHNICAL
• MATERIALS
• ENVIRONMENTAL

January 11, 2008

Mr. Ken Buhler
Department of Environment and Natural Resources (DENR)
Water Rights Division
Joe Foss Building
523 East Capitol
Pierre, South Dakota 57501-3181

Subject: South Dakota Water Well Completion Reports
Wells Installed for Powertech
Burdock, South Dakota
AET No. 18-02617

Dear Mr. Buhler:

Enclosed please find the well completion reports for five groundwater monitoring wells, DB-GW675, DB-GW676, DB-GW677, DB-GW678 & DB-GW679. The wells were completed to obtain information on the potential shallow groundwater impacts from previous uranium mining within the project area prior to initiating new uranium production activities within the Dewey-Burdock, South Dakota area. If you have any questions or need any additional information please contact me at (605) 388-0029.

Sincerely,

Clarke L. Knigge, CPRR
Environmental Scientist
Project Manager

CLK

attachments

pc: Mr. Cory Foreman, RESPEC

Y:\wp8\Environmental\Correspondence\18-02617 MW Completion Report.wpd

This document shall not be reproduced, except in full, without written approval of American Engineering Testing, Inc.
1745 Samco Road • Rapid City, SD 57702 • 605-388-0029 • Fax 605-388-0064 • www.amengtest.com
Chanhasen • Duluth • Mankato • Marshall • Rochester • St. Paul, MN/Pierre • Rapid City • Sioux Falls, SD/La Crosse • Wausau, WI
AN AFFIRMATIVE ACTION AND EQUAL OPPORTUNITY EMPLOYER.

DB-GW677

Location south of Putnam house

Construction Details

Total Depth	14.5'
Screen Interval	4.5 – 14.5'
Sand pack	3 – 14.5'
Bentonite	1 – 3'
Cement	0 – 1'

Water Level ~9' below surface

Lithology

0 – 4 ft	med tan, sandy silt
4 – 6 ft	sandy silt
6 – 7.5 ft	cobbles in silty sand, poorly sorted
7.5 – 9 ft	tan, silty sand
9 – 12.5 ft	wet, tan, very fine grained sand
12.5 -14.5 ft	dark gray, fissile shale (Belle Fourche Fm)



SOUTH DAKOTA WATER WELL COMPLETION REPORT

Location SW $\frac{1}{4}$ NE $\frac{1}{4}$ Sec 9 Twp 7S Rg 1E
 County Fall River
 Please mark well location with an "X"
 Long -104.001135 W
 Lat 43.459121 E
 Well Completion Date
9/25/2007

1 Mile

Well Owner: Powertech
 Business Name: Same
 Address: 145 N. Chicago Avenue, Suite C
Hot Springs, SD 57747

WELL LOG:

FORMATION	DEPTH	
	FROM	TO
<u>See Attached Log</u>		

RECEIVED
 JAN 15 2008
 WATER RIGHTS PROGRAM

LOCATION:
 Distance from nearest potential pollution source (septic tank, abandoned well, feed lot, etc.)? _____ ft. from _____ (identify source).

PROPOSED USE:
 Domestic/Stock Municipal Business Test Holes
 Irrigation Industrial Institutional Monitoring well

METHOD OF DRILLING:
4 1/4 ID HSA

CASING DATA: Steel Plastic Other
 If other describe PVC
 PIPEWEIGHT DIAMETER FROM TO HOLE DIAMETER
 _____ LB/FT 2 IN 2 1/2 FT 4 FT 8 1/2 IN
 _____ LB/FT _____ IN _____ FT _____ FT _____ IN
 _____ LB/FT _____ IN _____ FT _____ FT _____ IN

STATIC WATER LEVEL ≈ 9.6 Feet
 If flowing: closed in pressure Not flowing PSI
 GPM flow _____ through _____ inch pipe
 Controlled by Valve Reducers Other _____
 Reduced Flowrate _____ GPM
 Can well be completely shut in? _____

GROUTING DATA
 Grout Type No. of Sacks Grout Weight From To
 _____ lb./gal _____ ft. _____ ft. _____ ft.
 _____ lb./gal _____ ft. _____ ft. _____ ft.
 Describe grouting procedure Top 1' filled w/ concrete

WELL TEST DATA:
 Pumped Describe: Developed using a
 Bailed barrier. Well did not
 Other bail down
 Pumping Level Below Land Surface
 _____ ft. After _____ Hrs. pumped _____ GPM
 _____ ft. After _____ Hrs. pumped _____ GPM
 If pump installed, pump rate _____ GPM

SCREEN: Perforated pipe Manufactured
 Diameter 2 IN Length 10 FEET
 Material PVC
 Slot Size 0.010 Set From 4 Feet to 14 Feet
 Other information _____

REMARKS
Well Designation DB - GW 678

WAS A PACKER OR SEAL USED? YES NO
 If so, what material? 2' Bentonite
 Describe packer(s) and location? Above Sand Pack

This well was drilled under license # 678
 And this report is true and accurate.
 Drilling firm American Eng. Testing, Inc.
 Signatures of Licensor Representative:
[Signature]
 Signature of Well Owner or Equitable Property Holder:
[Signature]
 Date: 11/2/07

DISINFECTION: Was well disinfected upon completion?
 _____ YES, How: _____
 Laboratory sent to for water quality analysis
 NO, Why Not? Well not used for human or domestic animal consumption



BORING/WELL CONSTRUCTION LOG

PROJECT NUMBER 18-02617 **BORING/WELL NUMBER** B-3/DB-GW678
PROJECT NAME Dewey Burdock Monitor Well Installation **DATE DRILLED** 9/25/07
LOCATION Burdock, South Dakota **CASING TYPE/DIAMETER** 2" ID Schedule 40 PVC
DRILLING METHOD 4.25" ID HSA **SCREEN TYPE** 2" ID Schedule 40 PVC Slotted 0.010"
SAMPLING METHOD Continuous **PACKING TYPE** #10-20 Silica Sand
GROUND ELEVATION _____ **GROUT TYPE** Cement
TOP OF CASING _____ **DEPTH TO WATER** -8.00
LOGGED BY CH **GROUND WATER ELEVATION** _____
REMARKS Well was completed with a 4" Pro Top

HNu (ppm)	Blow Count	RECOVERY (inches)	SAMPLER TYPE	INTERVAL	DEPTH (ft. BGL)	U.S.C.S.	GRAPHIC LOG	MATERIAL DESCRIPTION	GW LEVEL
			CSTS 1		1				
					2				
					3				
			CSTS 2		4				
					5				
					6				
					7				
					8				
			CSTS 3		9				
					10				
					11				
					12				
					13				
					14				

AET_ENVI_18-02617 MM.GPJ AET_ENVI.GDT 11/26/07



**AMERICAN
ENGINEERING
TESTING, INC.**

**RECEIVED
JAN 15 2008
WATER RIGHTS
PROGRAM**

CONSULTANTS
• GEOTECHNICAL
• MATERIALS
• ENVIRONMENTAL

January 11, 2008

Mr. Ken Buhler
Department of Environment and Natural Resources (DENR)
Water Rights Division
Joe Foss Building
523 East Capitol
Pierre, South Dakota 57501-3181

Subject: South Dakota Water Well Completion Reports
Wells Installed for Powertech
Burdock, South Dakota
AET No. 18-02617

Dear Mr. Buhler:

Enclosed please find the well completion reports for five groundwater monitoring wells, DB-GW675, DB-GW676, DB-GW677, DB-GW678 & DB-GW679. The wells were completed to obtain information on the potential shallow groundwater impacts from previous uranium mining within the project area prior to initiating new uranium production activities within the Dewey-Burdock, South Dakota area. If you have any questions or need any additional information please contact me at (605) 388-0029.

Sincerely,

Clarke L. Knigge, CPRR
Environmental Scientist
Project Manager

CLK

attachments

pc: Mr. Cory Foreman, RESPEC

Y:\wp8\Environmental\Correspondence\18-02617 MW Completion Report.wpd

This document shall not be reproduced, except in full, without written approval of American Engineering Testing, Inc.
1745 Samco Road • Rapid City, SD 57702 • 605-388-0029 • Fax 605-388-0064 • www.amengtest.com
Chanhassen • Duluth • Mankato • Marshall • Rochester • St. Paul, MN/Pierre • Rapid City • Sioux Falls, SD/La Crosse • Wausau, WI
AN AFFIRMATIVE ACTION AND EQUAL OPPORTUNITY EMPLOYER.

Hydro ID 678

4 of 4

DB-GW678

Location along Pass Creek west of Burdock

Construction Details

Total Depth	14.5'
Screen Interval	4.5 – 14.5'
Sand pack	3 – 14.5'
Bentonite	1 – 3'
Cement	0 – 1'

Water Level ~8' below surface

Lithology

0 – 9 ft	very fine grained, red, silty sand
9 – 14 ft	dominantly vfg silty sand with 1" beds of med to coarse sand (did not penetrate shale)



SOUTH DAKOTA WATER WELL COMPLETION REPORT

Location NW 1/4 SE 1/4 Sec 27 Twp 6S Rg 1E
County Custer

Please mark well location with an "X"
Long -108.988091
Lat 43.499634
Well Completion Date 9/26/2007

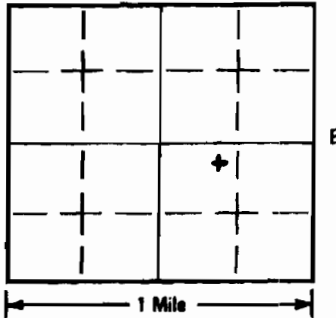

Well Owner: Powertech
Business Name: Same
Address: 145 N. Chicago Avenue, Suite C
Hot Springs, SD 57747

WELL LOG: FORMATION, DEPTH (FROM, TO). Includes 'RECEIVED JAN 15 2008 WATER RIGHTS PROGRAM' stamp.

LOCATION: Distance from nearest potential pollution source (septic tank, abandoned well, feed lot, etc.)? ft. from (identify source).

PROPOSED USE: Domestic/Stock, Municipal, Business, Test Holes, Irrigation, Industrial, Institutional, Monitoring well (checked).

METHOD OF DRILLING: 4 1/4 ID HSA

CASING DATA: Steel, Plastic (checked), Other. N other describe PVC. PIPEWEIGHT, DIAMETER, FROM, TO, HOLE DIAMETER table.

GROUTING DATA: Grout Type, No. of Sacks, Grout Weight, From, To. Describe grouting procedure Tremie pipe placement.

SCREEN: Perforated pipe, Manufactured (checked). Diameter 2 IN Length 20 FEET. Material PVC. Slot Size 0.010 Set From 19 Feet to 39 Feet.

WAS A PACKER OR SEAL USED? YES (checked) NO. If so, what material? 2' Bentonite. Describe packer(s) and location? Above Sand Pack.

DISINFECTION: Was well disinfected upon completion? YES, How: K.M.O. Why Not? Well not used for human or domestic animals.

Laboratory sent to for water quality analysis

STATIC WATER LEVEL 31.28 Feet. If flowing: closed in pressure Not flowing PSI. GPM flow through inch pipe. Controlled by Valve, Reducers, Other. Reduced Flowrate GPM. Can well be completely shut in?

WELL TEST DATA: Pumped, Bailed (checked), Other. Describe: Well developed using a bailer. Well did not bail down. Pumping Level Below Land Surface. ft. After Hrs. pumped GPM.

REMARKS: Well Designation: DB-6W679

This well was drilled under license # 678. And this report is true and accurate. Drilling firm American Engineering Testing, Inc. Signature of License Representative: Ken B. Hahn. Signature of Well Owner or Equitable Property Holder: [Signature].

Date: 11/2/07

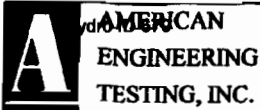

BORING/WELL CONSTRUCTION LOG

PROJECT NUMBER 18-02817 BORING/WELL NUMBER B-5/DB-GW579
 PROJECT NAME Dewey Burdock Monitor Well Installation DATE DRILLED 9/25/07
 LOCATION Burdock, South Dakota CASING TYPE/DIAMETER 2" ID Schedule 40 PVC
 DRILLING METHOD 4.25" ID HSA SCREEN TYPE 2" ID Schedule 40 PVC Slotted 0.010"
 SAMPLING METHOD Continuous PACKING TYPE #10-20 Silica Sand
 GROUND ELEVATION _____ GROUT TYPE Cement
 TOP OF CASING _____ DEPTH TO WATER _____
 LOGGED BY CH GROUND WATER ELEVATION _____
 REMARKS Well was completed with a 4" Pro Top

HNJ (ppm)	Blow Count	RECOVERY (inches)	SAMPLER TYPE	INTERVAL	DEPTH (ft. BGL)	U.S.C.S.	GRAPHIC LOG	MATERIAL DESCRIPTION	GW LEVEL	BORING ABANDONED
			CSTS 1	1	1			TOPSOIL, dark brown, dry		Concrete
			CSTS 2	2	2			SANDY SILT, red, dry		
			CSTS 3	3	3			SILTY SAND, red to tan, dry to moist		
			CSTS 4	4	4			SILTY SAND, red to tan, dry to moist		
			CSTS 5	5	5			SILTY SAND, red to tan, dry to moist		
			CSTS 6	6	6			SAND WITH GRAVEL, red moist		
			CSTS 7	7	7			SAND WITH GRAVEL, red moist		
			CSTS 8	8	8			SAND WITH GRAVEL, red moist		
			CSTS 9	9	9			SAND WITH GRAVEL, red moist		
			CSTS 10	10	10			SANDY LEAN CLAY, red moist		
			CSTS 11	11	11			SAND WITH GRAVEL, red moist 6 inch gray layer of sand at 30 feet		
			CSTS 12	12	12			SAND WITH GRAVEL, red moist		
			CSTS 13	13	13			SHALE, black, moist		

AET_ENM_18-02817_MNK.GPJ_AET_ENM.GDT_11/2/07



AMERICAN
ENGINEERING
TESTING, INC.

RECEIVED

JAN 15 2008

WATER RIGHTS
PROGRAM

CONSULTANTS
• GEOTECHNICAL
• MATERIALS
• ENVIRONMENTAL

January 11, 2008

Mr. Ken Buhler
Department of Environment and Natural Resources (DENR)
Water Rights Division
Joe Foss Building
523 East Capitol
Pierre, South Dakota 57501-3181

Subject: South Dakota Water Well Completion Reports
Wells Installed for Powertech
Burdock, South Dakota
AET No. 18-02617

Dear Mr. Buhler:

Enclosed please find the well completion reports for five groundwater monitoring wells, DB-GW675, DB-GW676, DB-GW677, DB-GW678 & DB-GW679. The wells were completed to obtain information on the potential shallow groundwater impacts from previous uranium mining within the project area prior to initiating new uranium production activities within the Dewey-Burdock, South Dakota area. If you have any questions or need any additional information please contact me at (605) 388-0029.

Sincerely,

Clarke L. Knigge, CPRR
Environmental Scientist
Project Manager

CLK

attachments

pc: Mr. Cory Foreman, RESPEC

Y:\wp8\Environmental\Correspondence\18-02617 MW Completion Report.wpd

This document shall not be reproduced, except in full, without written approval of American Engineering Testing, Inc.
1745 Sunco Road • Rapid City, SD 57702 • 605-388-0029 • Fax 605-388-0064 • www.amengtest.com
Chanhassen • Duluth • Mankato • Marshall • Rochester • St. Paul, MN/Pierre • Rapid City • Sioux Falls, SD/La Crosse • Wausau, WI
AN AFFIRMATIVE ACTION AND EQUAL OPPORTUNITY EMPLOYER.



B-5 Hydro ID 619B - GUN 679

6" Topsoil - Dk Tan, Dry

To 5' Sandy Silt Red Dry

To 10' Silty Sand, Rd to Tan, Dry to moist

To 15' Same Red

To 17' Same

To 17'-17 1/2' Sand w/ Gravel, Red, moist

17 1/2' - 19' Cobble, no carry

To 25' Silty Sand to Sand, Rd to Tan, moist

To 27' Sand w/ gravel, Red, moist

To 29' Sandy lean Clay, Red, wet

To 30' Sand w/ gravel, Red, moist, 6" Gray layer of Sand.

To 35' Sand w/ gravel, Red, moist silt @ 34.

To 36 1/2' Same

To 39' Shale, Dk Black, moist

COMPLETED BY:

REVIEWED BY:



POWERTECH (USA) INC.

NE 1/4 SW 1/4

Hydro ID 880

SOUTH DAKOTA WATER WELL COMPLETION REPORT

1 of 1 07-92

Location SW 1/4 NW 1/4 Sec 11 Twp 75 Rg 1 E
County Fall River North

Well Owner: Powertech
Business Name: Powertech USA Inc
Address: P.O. Box 723 Hot Springs S.D 57747

Please mark well location with an "X"

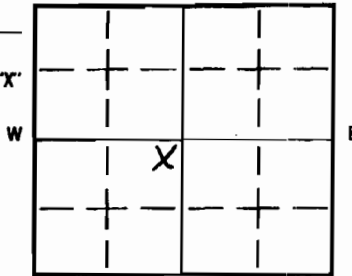

Well Completion Date

12-19-07

WELL LOG table with columns: FORMATION, FROM, TO. Rows include Skull Creek Sh, Fall River SS, Fuson Sh, Lakota SS.

LOCATION:

Distance from nearest potential pollution source (septic tank, abandoned well, feed lot, etc.)? ft. from NONE PRESENT (identify source).

PROPOSED USE:

- Domestic/Stock, Municipal, Business, Test Holes, Irrigation, Industrial, Institutional, Monitoring well

METHOD OF DRILLING:

Mud Rotary

CASING DATA: Steel, Plastic, Other

If other describe

Table with columns: PIPEWEIGHT, DIAMETER, FROM, TO, HOLE DIAMETER. Row 1: SDR 21 LB/FT, 6 IN, 0 FT, 426 FT, 8 3/4 IN.

GROUTING DATA

Table with columns: Grout Type, No. of Sacks, Grout Weight, From, To. Row 1: CMT, 95.3, 15.1 lb./gal, 426 ft, 0 ft.

Describe grouting procedure pump

SCREEN: Perforated pipe, Manufactured

Diameter 4 1/2 IN Length 10 FEET

Material PVC

Slot Size .025 Set From 436 Feet to 426 Feet

Other information Set with K Packer

WAS A PACKER OR SEAL USED? YES NO

If so, what material? 6" K Packer

Describe packer(s) and location? Packer 406'

DISINFECTION: Was well disinfected upon completion?

YES, How: NO, Why Not? NA

Laboratory sent to for water quality analysis

Respec

STATIC WATER LEVEL 29 Feet

If flowing: closed in pressure NA PSI

GPM flow through inch pipe

Controlled by Valve Reducers Other

Reduced Flowrate GPM

Can well be completely shut in? YES

WELL TEST DATA:

- Pumped, Bailed, Other (Describe: Airlift at 385')

Pumping Level Below Land Surface

ft. After Hrs. pumped 240 cubic Feet GPM

ft. After Hrs. pumped GPM

If pump installed, pump rate GPM

REMARKS Well DB-07-11-11C

lithology attached.

RECEIVED JAN 14 2008 WATER RIGHTS PROGRAM

This well was drilled under license # 745

And this report is true and accurate.

Drilling firm Davis Drilling Inc

Signature of License Representative: Stan Davis

Signature of Well Owner or Equitable Property Holder: Frank Lehman Powertech (USA) Inc

Date: 12-30-07



PowerTech (USA) Inc.

DRILLED WITH: AIR WATER HOLE NO. 0807-11-11C

T.D. 420' LOCATION: Section 11 T7S R1E 10'SE of 11-4C

BIT SIZE 6 1/4" to 2" logs - 1 1/2" bit.

SAMPLE LOG BY LE LEASE: (PROJECT) Dewey Burdock

DATE 10/10/07 COUNTY Ed. R. County STATE SD

DEPTH	LITHOLOGY	Alteration % Primary Oxidation	Reduction Secondary Oxidation	SAMPLE DESCRIPTION (Amounts in Percent, %)		T = Trace 1 = Minor 2 = Moderate 3 = Abundant
				L = Limestone (Lm) SOX = Surf. Oxidation Rd. Reduced Rt. Reduction P = Pyrite (Pyr) Py = Pyrite Ternish	POX = Primary Oxid. SOX = Surf. Oxid. SOX = Base of Surf. Oxid. SOX = Secondary Oxid. Tz = Transition Zone Fid = Feldspar	
0-5'						
5-10'						
10-15'						
15-20'						
20-25'						
25-30'						
30-35'						
35-40'						
40-45'						
45-50'						
50-55'						
55-60'						
60-65'						
65-70'						
70-75'						
75-80'						
80-85'						
85-90'						
90-95'						
95-100'						



PowerTech (USA) Inc.

Hydro ID 680

DRILLED WITH: AIR WATER HOLE NO. DC07-11-115

T.D. _____ LOCATION: _____

BIT SIZE _____

SAMPLE LOG BY _____ LEASE: (PROJECT) _____

DATE _____ COUNTY _____ STATE _____

DEPTH	LITHOLOGY	CARBON PYRITE DISSOLUTION	Alteration Primary Oxidation	Reduction Secondary Oxidation	SAMPLE DESCRIPTION (Amounts in Percent, %)		T = Trace 1 = Minor 2 = Moderate 3 = Abundant
					L = Limonite (Lm) SOX = Surf. Oxidation Rd. Reduced Ret. Reduction P = Pyrite (Pyr) P _r = Pyrite Tarnish	POX = Primary Oxid. SSOX = Base of Surf. Oxid. SOX = Secondary Oxid. T _z = Transition Zone Fid = Feldspar	
100							
110							
120							
120-135'							
130							
135-210'							
140							
150							
160							
170							
180							
190							
200							



PowerTech (USA) Inc.

Hydro ID 680

4 of 11

DRILLED WITH: AIR WATER HOLE NO. DAOT-11-11C

T.D. _____ LOCATION: _____

BIT SIZE _____

SAMPLE LOG BY _____ LEASE: (PROJECT) _____

DATE _____ COUNTY _____ STATE _____

DEPTH	LITHOLOGY	CARBON PYRITE OT	Alteration % Primary Oxidation Secondary Oxidation	SAMPLE DESCRIPTION		T = Trace 1 = Minor 2 = Moderate 3 = Abundant		
				L = Limonite (Lmn) SOX Surf. Oxidation Rd. Reduced Rdt. Reduction P = Pyrite (Pyr) P _r = Pyrite Ternish	(Amounts in Percent, %) POX = Primary Oxid. SOX = Surf. Oxid. SOX = Secondary Oxid. Tz = Transition Zone Fid = Feldspar	C = Carbon K = Kaolin S = Silica Ch = Chert		
200								
210					210-250'			
220					sl. silty fine gr. sandstone, brownish gray, med sorted, submg. submd, - mostly well sorted w/ some interbedded silty layers, reduced			
230								
240								
250					CORE INTERVAL 250 - 255' 8"			
260					255' 8" - 320'			
270					SHALE with interbedded SILTSTONE (mudstone), mostly reddish green # med. brown			
280								
290								
300								



PowerTech (USA) Inc.

Hydro ID 680

5 of 11

DRILLED WITH: AIR WATER HOLE NO. D207-11-11C

T.D. _____ LOCATION: _____

BIT SIZE _____

SAMPLE LOG BY _____ LEASE: (PROJECT) _____

DATE _____ COUNTY _____ STATE _____

DEPTH	LITHOLOGY	CARBON PYRITE	Alteration Primary Oxidation Secondary Reduction	L=Limonite (Lmn) SOX Surf. Oxidation Rd. Reduced Ret. Reduction P= Pyrite (Pyr) P _r = Pyrite Tarnish	SAMPLE DESCRIPTION (Amounts in Percent, %)		T=Trace 1=Minor 2=Moderate 3=Abundant C=Carbon S=Bleached K=Kaolin Ch=Chert
					POX= Primary Oxid. BSOX= Base of Surf. Oxid. SOX= Secondary Oxid. Tz= Transition Zone Fd= Feldspar		
340							
330							
320							
310							
300							
290							
280							
270							
260							
250							
240							
230							
220							
210							
200							
190							
180							
170							
160							
150							
140							
130							
120							
110							
100							

300-340'
fine gr. SANDSTONE, ll. brown - grayish brown, well sorted, med-sub med,
- more silty from 325-340' med sorted, mostly reduced LSOX.

340-410'
mostly shale with some silt interbeds, med gray



PowerTech (USA) Inc.

Hydro ID 680

6 of 11

DRILLED WITH: AIR WATER HOLE NO. DEW-11-11C

T.D. _____ LOCATION: _____

BIT SIZE _____

SAMPLE LOG BY _____ LEASE (PROJECT) _____

DATE _____ COUNTY _____ STATE _____

DEPTH	LITHOLOGY	CARBON OR PYLITE	Alteration % Primary Oxidation Reduction Secondary Oxidation	SAMPLE DESCRIPTION (Amounts in Percent, %)		T = Trace 1 = Minor 2 = Moderate 3 = Abundant C = Carbon S = Bleached K = Kaolin Ch = Chert
				L = Limonite (Lms) SOX Surf. Oxidation Rd. Reduced Rdt. Reduction P = Pyrite (Pyr) Py = Pyrite Tarnish	POX = Primary Oxid. BPOX = Base of Surf. Oxid. SOX = Secondary Oxid. Tz = Transition Zone Fid = Feldspar	
400						
410						
420						
430						
440						
450						
460						
470						
480						
490						
500						

CORE INTERVAL 410-420'

CORE INTERVAL 420-430'

CORE INTERVAL 430-440'

CORE INTERVAL 440-450'

TD 450' END OF HOLE



Hydro ID 680

PowerTech (USA) Inc.

7 of 11

DRILLED WITH: AIR WATER HOLE NO. D307-11-11C
 T.D. 450' LOCATION: Sec 11, T7S, R1E 10'S E of 11-4C
 BIT SIZE 6 1/4" to 3" over 4.5" bit
 SAMPLE LOG BY JT LEASE: (PROJECT) Dewey Burdock
 DATE 10/09/07 COUNTY Fall River STATE SD

DEPTH	LITHOLOGY	CARBON PYRITE	Alteration % Primary Oxidation Reduction Secondary Oxidation	SAMPLE DESCRIPTION		T = Trace 1 = Minor 2 = Moderate 3 = Abundant C = Carbon B = Bleached K = Kaolin Ch = Chert
				L = Limonite (Lm) SOX Surf. Oxidation Rd. Reduced Rdt. Reduction P = Pyrite (Pyr) P.T. = Pyrite Tornish	(Amounts in Percent, %) POX = Primary Oxid. B.OX = Base of Surf. Oxid. SOX = Secondary Oxid. Tz = Transition Zone Fid = Feldspar	
2502				COKE internal chert @ 249.1" grey, fine-grained, subrounded, pyritic clean, well-sorted, trace silt, 6% ss. colorless qtz grains. Acc. pyrite @ 250.4" to 250.55"		
2510				At 250, 9" contact black + dark gray fissile shale + mudstone		
2520						
2530						
2540						
2549				254.9" Increase in plastic clay content and decrease in fissility		
2550				255.2" grades quickly back to fine shale and mudstone.		
2580				255.9" TD of core run.		
2570						
2580						
2590						
2600						

CONFIDENTIAL



PowerTech (USA) Inc.

DRILLED WITH: AIR WATER

HOLE NO. DB07-11-11C

T.D. _____ LOCATION: _____

BIT SIZE 6 1/4"

SAMPLE LOG BY _____ LEASE: (PROJECT) _____

DATE _____ COUNTY _____ STATE _____

DEPTH	LITHOLOGY	CARBON	PYRITE	Alteration %	SAMPLE DESCRIPTION			
					L= Limonite (Lm)	SOX Surf. Oxidation	POX= Primary Oxid.	T= Trace
410					Rd. Reduced	SOX = Base of Surf. Oxid.	SOX = Secondary Oxid.	1 = Minor
					Rdt. Reduction	Tn = Transition Zone	Tn = Transition Zone	2 = Moderate
					P = Pyrite (Pyr)	fid = Feldspar	fid = Feldspar	3 = Abundant
					P = Pyrite Tarnish			C = Carbon
								B = Bleached
								K = Kaolin
								Ch = Chert
410					410' - 413' H. gray - gray low fissility SHALE / CLAYSTONE			
4110					* 410' 7 1/2" - 410' 10 1/2" SILTSTONE layer - well cemented			
4120								
4130					413' - 417' 10" H. gray - gray SHALE, subparallel fissility, r. low - longish			
4140								
4150								
4160								
4170								
4180								
4190								
4200								

CONFIDENTIAL

* TOTAL RUN LENGTH 10' 4" recovered 9' 6"

PowerTech (USA) Inc.

Hydro ID 680

DRILLED WITH: AIR WATER HOLE NO. D007-11-11C

T.D. _____ LOCATION: _____

BIT SIZE _____

SAMPLE LOG BY _____ LEASE: (PROJECT) _____

DATE _____ COUNTY _____ STATE _____

DEPTH	LITHOLOGY	CARBON PYRITE OT Mn	Alteration % Primary Oxidation Reduction Secondary Oxidation	SAMPLE DESCRIPTION		T = Trace 1 = Minor 2 = Moderate 3 = Abundant C = Carbon B = Bleached K = Kaolin Ch = Chert
				L = Limonite (Lma) SOX Surf. Oxidation Rd. Reduced Rdt. Reduction P = Pyrite (Pyr) P ₂ = Pyrite Tarnish	(Amounts in Percent, %) POX = Primary Oxid. SOX = Base of Surf. Oxid. 2OX = Secondary Oxid. Tz = Transition Zone Fid = Feldspar	
4200				4200-4204' H. gray-gray SHALE, subparallel fissility, v. low strength		
4210						
4220				← low angle slip plane 422' 1" ← 422' 6" slip plane in 45"		
4230						
4240				424-500' sh. w/lt. fine gr. SANDSTONE: H. gray. H. brownish gray, - med. well sorted, columnar-subbed, mostly subbed, mostly well - cemented, mod. cemented 425-425' 3" + 426-426' 5.5", - ss. lenticle interbedded from 424-425' 8", continuous carbon layers from 426-426' 5.5", loc. pyrite		
4250						
4260						
4270						
4280				CONFIDENTIAL		
4290						
4300				* TOTAL RUN LENGTH 10' 7" MINUS 10' 0"		



POWERTECH (USA) INC.

DRILLED WITH: AIR WATER HOLE NO. 0807-11-11C 10 OF 11

T.D. _____ LOCATION: _____

BIT SIZE _____

SAMPLE LOG BY _____ LEASE: (PROJECT) _____

DATE _____ COUNTY _____ STATE _____

DEPTH	LITHOLOGY	CARBON PYRITE OTHER	Alteration % Primary Oxidation Reduction Secondary Oxidation	SAMPLE DESCRIPTION		T=Trace 1=Minor 2=Moderate 3=Abundant C=Carbon B=Bleached K=Kaolin Chr=Chert
				L= Limestone (Lam) SOX Surf. Oxidation Rd. Reduced Rdt. Reduction P= Pyrite (Pyr) P ₂ = Pyrite Tornish	(Amounts in Percent, %) POX= Primary Oxid. BEOX = Base of Surf. Oxid. SOX = Secondary Oxid. Tn = Transition Zone fid = Feldspar	
4730					4730-4731' SAMPLE WASHED AWAY	
4731						
4732					4731-4732' 6" v. sl. silty, fine gr. SANDSTONE, ll. gray - ll. brownish gray, - well-sorted, subang. subbed, mostly subbed, well-concreted, sect. pyrite	
4733					4732' 6" - 4733' 5" silty, v. fine gr. SANDSTONE, ll. gray - ll. brownish gray, - med. sorted, subang. subbed, med. concreted - partly concreted, sect. pyrite, - thin, continuous, large carbon stringers 4732' 9" - 4733' 6"	
4734					- calcite cement? - will need to test w/ acid, soaked qtz grains -> - touchment "root beer" colored coating, low angle bedding evident by	
4735					- alternating dk ± ll. layers in sands. - 200 µR/hr 4735-4736', 40 µR/hr 111' of sands	
4736						
4737						
4738					* bottom 3" SAA, but mostly fine gr. ss	
4739					4738' 5" - 4740' 0" SAMPLE WASHED AWAY	
4740						

CONFIDENTIAL

Hydro ID 680

PowerTech (USA) Inc.

11 of 11

DRILLED WITH: AIR WATER HOLE NO. 0007-11-11C

T.D. _____ LOCATION: _____

BIT SIZE _____

SAMPLE LOG BY _____ LEASE: (PROJECT) _____

DATE _____ COUNTY _____ STATE _____

DEPTH	LITHOLOGY	CARBON	PYRITE	Alteration Oxidation Primary Oxidation Reduction Secondary Oxidation	SAMPLE DESCRIPTION (Amounts in Percent, %)		T = Trace 1 = Minor 2 = Moderate 3 = Abundant C = Carbon K = Kaolin B = Bleached Ch = Chert
					L: Limonite (Lm) SOX Surf. Oxidation Rd. Reduced Rdt. Reduction P = Pyrite (Pyr) Py = Pyrite Tarnish	POX = Primary Oxid. BSOX = Base of Surf. Oxid. SOX = Secondary Oxid. TZ = Transition Zone Fd = Feldspar	
440						440 - 440'6" CORE WASHED AWAY	
4410						440'6" - 441'10" fine gr. SANDSTONE, lt. gray - lt. brownish gray, med. well sorted, subangular subrounded, mostly subrounded, well cemented, thin, continuous carbon layers	
4420						441'10" - 442'10" fine-med. gr. SANDSTONE, lt. brownish gray - med. gray, poorly sorted, med. subrounded, sat. coarse gr. sand in 441'10" - 444'0" med. coarse gr. SANDSTONE 441'0" - 442'1" dominant coarse gr. at bottom, smt. pyrite, fine gr. SS 442'1" - 447'3", med. gr. SS 447'3" - 448'10"	
4430						lots of chert - coarse grains - angular	
4440						* med. coarse gr. SS (444'0" - 446'1")	
4450						- 20 μR por - all por	
4460						* fine gr. SS (446'1" - 447'3")	
4470						* med. gr. SS w/ smt. abundant coarse gr. (447'3" - 448'10") - carbon from stringer @ 447'10"	
4480							
4490						448'10" - 449'7" CORE LOSS	CONFIDENTIAL
4500						* TOTAL CORE LENGTH 9'7" RECOVERED 8'6"	



SOUTH DAKOTA WATER WELL COMPLETION REPORT

Location NE NW Sec 37 Twp 6S Rg 1E
County CUSTER North

Please mark well location with an "X"

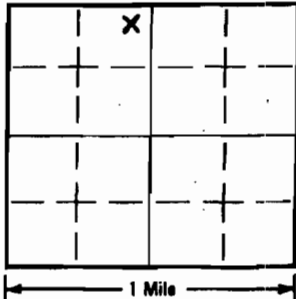

Well Completion Date
1-27-08

Well Owner: Powertech
Business Name: Powertech USA Inc
Address: P.O. Box 723
Hot Springs S.D. 57747

FORMATION	DEPTH	
	FROM	TO
Small Creek Shale	0	470'
Fall River Sandstone	470'	585'

LOCATION: Distance from nearest potential pollution source (septic tank, abandoned well, feed lot, etc.)? ft. from NONE Present (identify source).

PROPOSED USE:
 Domestic/Stock Municipal Business Test Holes
 Irrigation Industrial Institutional Monitoring well

METHOD OF DRILLING:
Mud Rotary

CASING DATA: Steel Plastic Other
If other describe _____
PIPEWEIGHT DIAMETER FROM TO HOLE DIAMETER
SDR 21 LB/FT 6 IN 0 FT 585 FT 8 1/4 IN
____ LB/FT ____ IN ____ FT ____ FT ____ IN
____ LB/FT ____ IN ____ FT ____ FT ____ IN

STATIC WATER LEVEL _____ Feet
If flowing: closed in pressure 6.1 PSI
GPM flow 10 through 2 inch pipe
Controlled by Valve Reducers Other _____
Reduced Flowrate _____ GPM
Can well be completely shut in? YES

GROUTING DATA
Grout Type No. of Sacks Grout Weight From To
CMT 96 15.2 lb./gal 585 ft. 0 ft
____ lb./gal ____ ft. ____ ft.
Describe grouting procedure pump

WELL TEST DATA:
 Pumped Describe: Air Lift at 575'
 Bailed _____
 Other _____
Pumping Level Below Land Surface
____ ft. After ____ Hrs. pumped ____ GPM
____ ft. After ____ Hrs. pumped ____ GPM
If pump installed, pump rate ____ GPM

SCREEN: Perforated pipe Manufactured
Diameter 3 IN Length 15 FEET
Material PVC
Slot Size .020 Set From 600 Feet to 585 Feet
Other information set K Packers

REMARKS Dewey Burdock RECEIVED
FEB 22 2008

WAS A PACKER OR SEAL USED? YES NO
if so, what material? 6" K Packer
Describe packer(s) and location? Pack. 575'

WATER RIGHTS PROGRAM
This well was drilled under license # 745

DISINFECTION: Was well disinfected upon completion?
YES, How: _____
Laboratory sent to for water quality analysis: Respic
NO, Why Not? NA

And this report is true and accurate.
Drilling firm: DAVIS Drilling Inc
Signature of License Representative: Sta. Davis
Signature of Well-Owner or Equitable Property Holder: Powertech
Date: 2/13/08



Hydro ID 682

7S

SOUTH DAKOTA WATER WELL COMPLETION REPORT

1 of 1 07-92

Location SE 1/4 NW 1/4 Sec 11 Twp 65 Rg 1E
County Fall River North

lease mark well location with an "X"

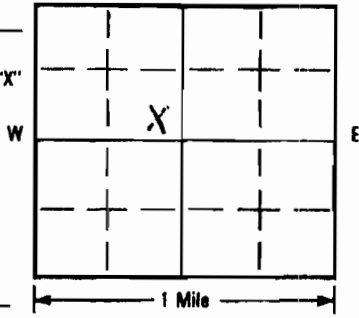

Well Completion Date

2-21-08

Well Owner: Powertech

Business Name: Powertech USA INC

Address: P.O. Box 723
Hot Springs SD 57747

FORMATION	DEPTH	
	FROM	TO
Skull Creek Shale	0	145
Fall River Sandstone	145	310
Fuson Shale	310	335
Lakota	335	460

LOCATION:

Distance from nearest potential pollution source (septic tank, abandoned well, shed lot, etc.)? _____ ft. from NONE PRESENT (identify source).

PROPOSED USE:

- Domestic/Stock
- Municipal
- Business
- Test Holes
- Irrigation
- Industrial
- Institutional
- Monitoring well

METHOD OF DRILLING:

Mud Rotary

casing DATA: Steel Plastic Other

If other describe _____

PIPEWEIGHT	DIAMETER	FROM	TO	HOLE DIAMETER
22.12 LB/FT	4 IN	0 FT	450 FT	6 3/4 IN
_____ LB/FT	_____ IN	_____ FT	_____ FT	_____ IN
_____ LB/FT	_____ IN	_____ FT	_____ FT	_____ IN

GROUTING DATA

Grout Type	No. of Sacks	Grout Weight	From	To
CMT	67	15.4 lb./gal	0 ft	450 ft
_____	_____	_____ lb./gal	_____ ft	_____ ft

Describe grouting procedure Pump

SCREEN: Perforated pipe Manufactured

Diameter 2 IN Length 10 FEET

Material PVC

Slot Size .020 Set From 460 Feet to 450 Feet

Other information Set K Packer

WAS A PACKER OR SEAL USED? YES NO

If so, what material? 4" K Packer

Describe packer(s) and location? Packer 440'

DISINFECTION: Was well disinfected upon completion?

YES, How: _____

laboratory sent to for water quality analysis X NO. Why Not? NA

Respec

STATIC WATER LEVEL 54.2 Feet

If flowing: closed in pressure _____ PSI

GPM flow _____ through _____ inch pipe

Controlled by Valve Reducers Other _____

Reduced Flowrate _____ GPM

Can well be completely shut in? Yes

WELL TEST DATA:

Pumped Describe: Air lift at 435'

Bailed _____

Other _____

Pumping Level Below Land Surface

_____ ft. After _____ Hrs. pumped _____ GPM

_____ ft. After _____ Hrs. pumped _____ GPM

If pump installed, pump rate _____ GPM

REMARKS

Dewey Burdock RECEIVED

7-11-2

MAR 24 2008

WATER RIGHTS PROGRAM

This well was drilled under license # 745

And this report is true and accurate

Drilling firm DAVIS Drilling INC

Signature of License Representative: Stan Davis

Signature of Well Owner or Equitable Property Holder:

[Signature]

Date: 3/5/08



SOUTH DAKOTA WATER WELL COMPLETION REPORT

Location NW 1/4 SE 1/4 Sec 29 Twp 65 Rg 1E
 County CUSTER North
 Please mark well location with an "X"
 NE 1/4 SW 1/4
 Well-Completion Date 3-8-08
 1 Mile

Well Owner: Powertech
 Business Name: Powertech USA INC
 Address: P.O. Box 723
 Hot Springs SD 57747

WELL LOG:

FORMATION	DEPTH	
	FROM	TO
Skull Creek Shale	0	530
Fall River S.S.	530	650

RECEIVED
 MAR 24 2008
 WATER RIGHTS PROGRAM

LOCATION:
 Distance from nearest potential pollution source (septic tank, abandoned well, feed lot, etc.)? NONE PRESENT ft. from (identify source).

PROPOSED USE:

Domestic/Stock Municipal Business Test Holes
 Irrigation Industrial Institutional Monitoring well

METHOD OF DRILLING:
 Mud Rotary

CASING DATA: Steel Plastic Other

If other describe:

PIPEWEIGHT	DIAMETER	FROM	TO	HOLE DIAMETER
SDR 17 LB/FT	4 IN	0 FT	635 FT	6 3/4 IN
LB/FT	IN	FT	FT	IN
LB/FT	IN	FT	FT	IN

STATIC WATER LEVEL 81.9 Feet
 If flowing: closed in pressure _____ PSI
 GPM flow _____ through _____ inch pipe
 Controlled by Valve Reducers Other _____
 Reduced Flowrate _____ GPM
 Can well be completely shut in? Yes

GROUTING DATA

Grout Type	No. of Sacks	Grout Weight	From	To
CMT	77	15.2 lb./gal	0 ft.	635 ft.
		lb./gal	ft.	ft.

Describe grouting procedure: pump

WELL TEST DATA:

Pumped Describe: Air lift at 620'
 Bailed
 Other

Pumping Level Below Land Surface
 _____ ft. After _____ Hrs. pumped _____ GPM
 _____ ft. After _____ Hrs. pumped _____ GPM
 If pump installed, pump rate _____ GPM

SCREEN: Perforated pipe Manufactured
 Diameter 2 IN Length 15 FEET
 Material PVC
 Slot Size: 0.20 Set From 650 Feet to 635 Feet
 Other information: Set K Packer

REMARKS: DEWEY Burdock 7-29-7

WAS A PACKER OR SEAL USED? YES NO
 If so, what material? 4" K Packer
 Describe packer(s) and location? Packer 625'

This well was drilled under license # 745
 And this report is true and accurate.
 Drilling firm: Davis Drilling INC
 Signature of License Representative: Stan Davis
 Signature of Well Owner or Equitable Property Holder: Powertech
 Date: 3/8/08

DISINFECTION: Was well disinfected upon completion?
 YES, How: _____
 NO, Why Not? X NA

Laboratory sent to for water quality analysis: Respec



SOUTH DAKOTA WATER WELL COMPLETION REPORT

Location NE 1/4 SW 1/4 Sec 11 Twp 7S Rg 1E
County Fall River North

Well Owner: Powertech
Business Name: Powertech USA Inc
Address: P.O. Box 723
Hot Springs SD 57747

Please mark well location with an "X"

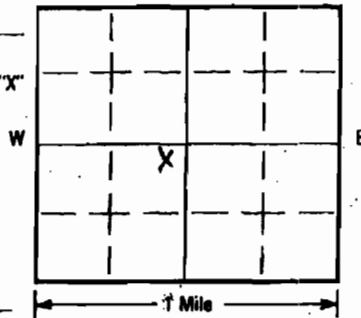

Well Completion Date

2-13-08

FORMATION	DEPTH	
	FROM	TO
Skull Creek Sand	0	102'
Fall River Sandstone	102'	238'
Fuson Shale	238'	300'
Lakota Sandstone	300'	423'

LOCATION:

Distance from nearest potential pollution source (septic tank, abandoned well, feed lot, etc.)? ft. from NONE (identify source).

PROPOSED USE:

- Domestic/Stock
- Municipal
- Business
- Test Holes
- Irrigation
- Industrial
- Institutional
- Monitoring well

METHOD OF DRILLING:

Mud Rotary

CASING DATA: Steel Plastic Other

If other describe

PIPEWEIGHT LB/FT	DIAMETER IN	FROM FT	TO FT	HOLE DIAMETER IN
SDR17	4	0	413	6 3/4

GROUTING DATA

Grout Type	No. of Sacks	Grout Weight lb./gal	From ft.	To ft.
MT	66	15.2	0	413

Describe grouting procedure pump

SCREEN: Perforated pipe Manufactured

Diameter 2 IN Length 10 FEET

Material PVC

Slot Size .020 Set From 423 Feet to 413 Feet

Other information 5' k Packer

WAS A PACKER OR SEAL USED? YES NO

If so, what material? 4" k Packer

Describe packer(s) and location? Packer 403

DISINFECTION: Was well disinfected upon completion?

YES, How:

NO, Why Not? NA

Laboratory sent to for water quality analysis

Respec

RECEIVED

MAR 11 2008

WATER RIGHTS PROGRAM

STATIC WATER LEVEL 28.8 Feet

If flowing: closed in pressure PSI

GPM flow through inch pipe

Controlled by Valve Reducers Other

Reduced Flowrate GPM

Can well be completely shut in? YES

WELL TEST DATA:

Pumped Describe: Air-lift AT 400

Bailed

Other

Pumping Level Below Land Surface

ft. After Hrs. pumped GPM

ft. After Hrs. pumped GPM

If pump installed, pump rate GPM

REMARKS DEWEY Burdock 11-14 C

This well was drilled under license # 745

And this report is true and accurate.

Drilling firm DAVIS Drilling Inc

Signature of License Representative: Stan Davis

Signature of Well Owner or Equitable Property Holder:

Powertech

Date: 2/17/08



SOUTH DAKOTA WATER WELL COMPLETION REPORT

Location NW $\frac{1}{4}$ NE $\frac{1}{4}$ Sec 32 Twp 6S Rg 1E
 County Custer North

Please mark well location with an "X"

Well-Completion Date
2-4-08

Well Owner: Powertech
 Business Name: Powertech USA Inc
 Address: P.O. Box 723
Hot Springs SD. 57747

WELL LOG: FORMATION	DEPTH	
	FROM	TO
<u>Skull Creek shale</u>	<u>0</u>	<u>473'</u>
<u>Fall River sandstone</u>	<u>473'</u>	<u>595'</u>

RECEIVED
 MAR - 8 2008
 WATER RIGHTS PROGRAM

LOCATION:
 Distance from nearest potential pollution source (septic tank, abandoned well, feed lot, etc.)? _____ ft. from NONE Present (identify source).

PROPOSED USE:

Domestic/Stock Municipal Business Test Holes
 Irrigation Industrial Institutional Monitoring well

METHOD OF DRILLING:
Mud Rotary

CASING DATA: Steel Plastic Other
 If other describe 0

PIPEWEIGHT	DIAMETER	FROM	TO	HOLE DIAMETER
<u>SDR 17</u> LB/FT	<u>4</u> IN	<u>595</u> FT	<u>580</u> FT	<u>6 3/4</u> IN

STATIC WATER LEVEL 0 Feet
 If flowing: closed in pressure 6 PSI
 GPM flow 15 through 2 inch pipe
 Controlled by Valve Reducers Other
 Reduced Flowrate _____ GPM
 Can well be completely shut in? Yes

GROUTING DATA

Grout Type	No. of Sacks	Grout Weight	From	To
<u>CMT</u>	<u>77</u>	<u>122</u> lb./gal	<u>0</u> ft.	<u>580</u> ft.

Describe grouting procedure pump

WELL TEST DATA:
 Pumped Describe: Air lift in 570'
 Bailed
 Other
 Pumping Level Below Land Surface
 _____ ft. After _____ Hrs. pumped _____ GPM
 _____ ft. After _____ Hrs. pumped _____ GPM
 If pump installed, pump rate _____ GPM

SCREEN: Perforated pipe Manufactured
 Diameter 2 IN Length 15 FEET
 Material PVC
 Slot Size .020 Set from 595 Feet to 580 Feet
 Other information Set to Packer

REMARKS Dewey Burdock 32-4C

WAS A PACKER OR SEAL USED? YES NO
 If so, what material? 4" K Packer
 Describe packer(s) and location? Packer 570'

This well was drilled under license # 745
 And this report is true and accurate.
 Drilling firm Davis Drilling Inc
 Signature of License Representative: Stan Davis
 Signature of Well Owner or Equitable Property Holder: [Signature]
 Date: 2/27/08

DISINFECTION: Was well disinfected upon completion?
 YES, How: _____
 NO, Why Not? NA

Laboratory sent to for water quality analysis
Respec



SOUTH DAKOTA WATER WELL COMPLETION REPORT

Location ~~NE~~ ~~SW~~ ~~SE~~ ~~NW~~ Twp 65 Rg 1E
County NE SW 11 North
Fall River

Well Owner: Powertech
Business Name: Powertech USA INC
Address: P.O. Box 723
Hot Springs S.D 57747

Please mark well location with an "X"

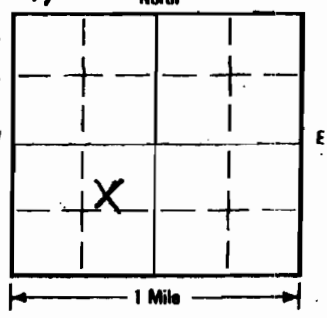

Well-Completion Date
2-24-08

FORMATION	DEPTH	
	FROM	TO
<u>Skull Creek Shale</u>	<u>0</u>	<u>120</u>
<u>Fall River SS</u>	<u>120</u>	<u>255</u>
<u>Fuson Shale</u>	<u>255</u>	<u>315</u>
<u>Lakota Sandstone</u>	<u>315</u>	<u>428</u>

LOCATION:
Distance from nearest potential pollution source (septic tank, abandoned well, feed lot, etc.)? NONE PRESENT ft. from (identify source).

RECEIVED
MAR 11 2008
WATER RIGHTS PROGRAM

PROPOSED USE:
 Domestic/Stock Municipal Business Test Holes
 Irrigation Industrial Institutional Monitoring well

METHOD OF DRILLING:
Mod Rotary

STATIC WATER LEVEL 32.6 Feet
If flowing: closed in pressure _____ PSI
GPM flow _____ through _____ inch pipe
Controlled by Valve Reducers Other _____
Reduced Flowrate _____ GPM
Can well be completely shut in? Yes

CASING DATA: Steel Plastic Other
If other describe _____
PIPEWEIGHT DIAMETER FROM TO HOLE DIAMETER
SPR 17 LB/FT 4 IN 0 FT 419 FT 6 3/4 IN
____ LB/FT _____ IN _____ FT _____ FT _____ IN
____ LB/FT _____ IN _____ FT _____ FT _____ IN

WELL TEST DATA:
 Pumped Describe: Artif lift at 408'
 Bailed _____
 Other _____
Pumping Level Below Land Surface
_____ ft. After _____ Hrs. pumped _____ GPM
_____ ft. After _____ Hrs. pumped _____ GPM
If pump installed, pump rate _____ GPM

GROUTING DATA
Grout Type CMT No. of Sacks 70 Grout Weight 15.2 lb./gal From 0 ft To 418 ft
____ lb./gal _____ ft _____ ft _____ ft
Describe grouting procedure Pump

SCREEN: Perforated pipe Manufactured
Diameter 2 IN Length 10 FEET
Material PVC
Slot Size .020 Set From 418 Feet to 428 Feet
Other information Set K Packer

REMARKS
Dewey Burdock 7-11-15

WAS A PACKER OR SEAL USED? YES NO
If so, what material? 4" K Packer
Describe packer(s) and location? Packer 408'

This well was drilled under license # 745
And this report is true and accurate.
Drilling firm DAVIS Drilling INC
Signature of License Representative: Star Davis
Signature of Well Owner or Equitable Property Holder: [Signature]
Date: 3/5/08

DISINFECTION: Was well disinfected upon completion?
YES, How: _____
NO, Why Not? NA
Laboratory sent to for water quality analysis Respec



Hydro ID 687

SOUTH DAKOTA WATER WELL COMPLETION REPORT

1 of 1 07-92

Location NE 1/4 NW 1/4 Sec 32 Twp 6S Rg 1E
County Luster

Please mark well location with an "X"

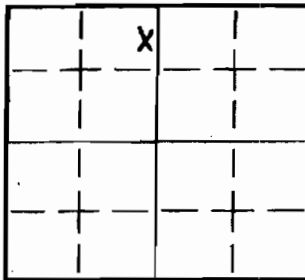

Well-Completion Date

2-6-08

Well Owner: Powertech
Business Name: Powertech USA Inc
Address: P.O. Box 723
Hot Springs S.D. 57747

FORMATION	DEPTH	
	FROM	TO
Skull Creek Shale	0	480'
Fall River Sandstone	480'	605'

RECEIVED
MAR - 6 2008
WATER RIGHTS PROGRAM

LOCATION:

Distance from nearest potential pollution source (septic tank, abandoned well, feed lot, etc.)? ft. from NONE Present (identify source).

PROPOSED USE:

- Domestic/Stock
- Municipal
- Business
- Test Holes
- Irrigation
- Industrial
- Institutional
- Monitoring well

METHOD OF DRILLING:

Mud Rotary

CASING DATA: Steel Plastic Other

If other describe

PIPEWEIGHT	DIAMETER	FROM	TO	HOLE DIAMETER
SDR 17 LB/FT	4 IN	0 FT	590 FT	6 3/4 IN
LB/FT	IN	FT	FT	IN
LB/FT	IN	FT	FT	IN

GROUTING DATA

Grout Type	No. of Sacks	Grout Weight	From	To
CMT	60	15.2 lb./gal	590 ft	0 ft
		lb./gal	ft	ft

Describe grouting procedure pump

SCREEN: Perforated pipe Manufactured

Diameter 2 IN Length 15 FEET
Material PVC
Slot Size .020 Sat From 605 Feet to 590 Feet
Other information Seal K Packer

WAS A PACKER OR SEAL USED? YES NO

If so, what material? 4" K Packer
Describe packer(s) and location? Packer 580'

DISINFECTION: Was well disinfected upon completion?

YES, How: NO, Why Not? NA

Laboratory sent to for water quality analysis

Respic

STATIC WATER LEVEL 0 Feet
If flowing: closed in pressure 3 PSI
GPM flow 5 through 2 inch pipe
Controlled by Valve Reducers Other
Reduced Flowrate GPM
Can well be completely shut in? Yes

WELL TEST DATA:

Pumped Describe: Air lift at 580'
 Bailed
 Other
Pumping Level Below Land Surface
ft. After Hrs. pumped GPM
ft. After Hrs. pumped GPM
If pump installed, pump rate GPM

REMARKS DEWEY BURDOCK 7-32.5

This well was drilled under license # 745
And this report is true and accurate.
Drilling firm DAVIS Drilling INC
Signature of License Representative: Stan Davis
Signature of Well Owner or Equitable Property Holder: Powertech
Date: 2/27/08

3-7-08



7S

SOUTH DAKOTA WATER WELL COMPLETION REPORT

Location NE 1/4 SW 1/4 Sec 11 Twp 6S Rg 1E
County Fall River North

Well Owner: Power-Tell
Business Name: Power-Tell USA INC
Address: P.O. Box 723
Hot Springs SD 57747

Please mark well location with an "X"

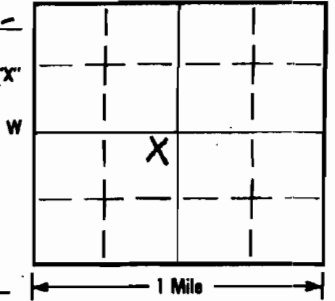

Well-Completion Date

4-1-08

WELL LOG:

FORMATION	DEPTH	
	FROM	TO
Skull Creek	0	128
Fall River	128	255

LOCATION:

Distance from nearest potential pollution source (septic tank, abandoned well, food lot, etc.)? ft. from None Present (identify source).

PROPOSED USE:

- Domestic/Stock
- Municipal
- Business
- Test Holes
- Irrigation
- Industrial
- Institutional
- Monitoring well

METHOD OF DRILLING:

mud & Rotary

CASING DATA:

- Steel
- Plastic
- Other

If other describe

PIPEWEIGHT	DIAMETER	FROM	TO	HOLE DIAMETER
SDR 17 LB/FT	6 IN	0 FT	245 FT	8 3/4 IN

GROUTING DATA

Grout Type	No. of Sacks	Grout Weight	From	To
CM 1	45	15.3 lb./gal	0 ft	245 ft

Describe grouting procedure

Pump

SCREEN: Perforated pipe Manufactured

Diameter 3 IN Length 10 FEET

Material PVC

Slot Size .020 Set From 245 Feet to 255 Feet

Other information Set K Packer

WAS A PACKER OR SEAL USED? YES NO

If so, what material? 6" x 3" K Packer

Describe packer(s) and location? Packer set at 235'

DISINFECTION: Was well disinfected upon completion?

YES, How:
 X NO, Why Not? NA

Laboratory sent to for water quality analysis

Riesper

STATIC WATER LEVEL

39

Feet

If flowing: closed in pressure PSI

GPM flow through inch pipe

Controlled by Valve Reducers Other

Reduced Flowrate GPM

Can well be completely shut in? Yes

WELL TEST DATA:

- Pumped Describe: No. 1111 AT 230'
- Bailed
- Other

Pumping Level Below Land Surface

ft. After Hrs. pumped

ft. After Hrs. pumped

If pump installed, pump rate GPM

REMARKS

Dewey Burdock

8-11-17

This well was drilled under license # 745

And this report is true and accurate.

Drilling firm Davis Drilling

Signature of License Representative: Stan Davis

Signature of Well-Owner or Equitable Property Holder:

Date: 4/20/08

80-1-5



SOUTH DAKOTA WATER WELL COMPLETION REPORT

Location NE 1/4 NW 1/4 Sec 32 Twp 65 Rg 1E
County Custer North

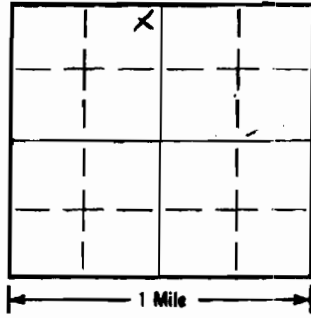

Please mark well location with an "X"

Well-Completion Date
3-11-08

Well Owner: Power-Tech
Business Name: Power-Tech USA INC
Address: P.O. Box 723
Hot Springs, S.D. 57747

FORMATION	DEPTH	
	FROM	TO
Shall Loach shale	0	475
Fall River ss	475	620
Fusion shale	620	665
Lakota ss	665	715

LOCATION:
Distance from nearest potential pollution source (septic tank, abandoned well, feed lot, etc.)? None Present (identify source).

PROPOSED USE:
 Domestic/Stock Municipal Business Test Holes
 Irrigation Industrial Institutional Monitoring well

METHOD OF DRILLING:
Mud & Rotary

CASING DATA: Steel Plastic Other
other describe

PIPEWEIGHT	DIAMETER	FROM	TO	HOLE DIAMETER
8.17 LB/FT	6 IN	0 FT	715 FT	8 3/4 IN
LB/FT	IN	FT	FT	IN
LB/FT	IN	FT	FT	IN

GROUTING DATA	No. of Sacks	Grout Weight	From	To
CMT	86	15.2 lb./gal	0 ft.	715 ft.
		lb./gal	ft.	ft.

Describe grouting procedure Pump

SCREEN: Perforated pipe Manufactured
Diameter 3 IN Length 15 FEET
Material PVC
Slot Size 20 Set From 730 Feet to 715 Feet
Other information Set k Parker

WAS A PACKER OR SEAL USED? YES NO
If so, what material? 6" k Parker
Describe packer(s) and location? Packer Set at 705'

DISINFECTION: Was well disinfected upon completion?
YES, How: NO, Why Not? NA

Laboratory sent to for water quality analysis
Rajeev

STATIC WATER LEVEL 0 Feet
If flowing: closed in pressure 23.5 PSI
GPM flow 45 through 2 inch pipe
Controlled by Valve Reducers Other
Reduced Flowrate GPM
Can well be completely shut in? Yes

WELL TEST DATA:
 Pumped Describe: A: 1:12 AT 700'
 Bailed
 Other
Pumping Level Below Land Surface
ft. After Hrs. pumped GPM
ft. After Hrs. pumped GPM
If pump installed, pump rate GPM

RECEIVED
APR - 1 2008
WATER RIGHTS PROGRAM

REMARKS
DEWET Burdock
8-32-10 → 7-32-10

This well was drilled under license # 745
And this report is true and accurate.
Drilling firm Davis Drilling, Inc.
Signature of License Representative: Sha D.

Signature of Well-Owner or Equitable Property Holder:
Date: 3/15/08



Hydro ID 690

7S

SOUTH DAKOTA WATER WELL COMPLETION REPORT

1 of 1 07-92

Location NE 1/4 SW 1/4 Sec 11 Twp 65 Rg 1E
County Fall River North

Please mark well location with an "X"

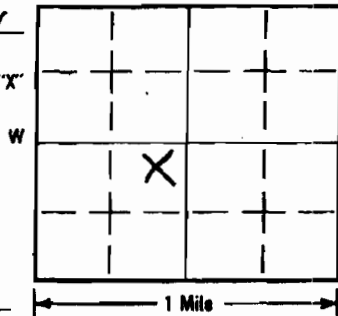

Well Completion Date

4-15-08

Well Owner: Power Tech
Business Name: Power Tech USA INC
Address: P.O. Box 723
Hot Springs S.D. 57747

FORMATION	DEPTH	
	FROM	TO
Skull Creek	0	115
Fall River	115	245
Fuson	245	310
Lakota	310	455
Morrison	455	560
UNKPAPA	560	621

LOCATION:
Distance from nearest potential pollution source (septic tank, abandoned well, feed lot, etc.)? _____ ft. from NONE Present (Identify source).

PROPOSED USE:
 Domestic/Stock Municipal Business Test Holes
 Irrigation Industrial Institutional Monitoring well

METHOD OF DRILLING:
Mud Rotary

CASING DATA: Steel Plastic Other
If other describe _____
PIPEWEIGHT DIAMETER FROM TO HOLE DIAMETER
18 LB/FT 3.6 IN 0 FT 621 FT 8 3/4 IN

STATIC WATER LEVEL _____ Feet
If flowing: closed in pressure 41 PSI
GPM flow 14 through 2 inch pipe
Controlled by Valve Reducers Other
Reduced Flowrate _____ GPM
Can well be completely shut in? Yes

GROUTING DATA
Grout Type No. of Sacks Grout Weight From To
Cm 104 15.7 lb./gal 0 ft 621 R

WELL TEST DATA:
 Pumped Describe: A little in 605
 Bailed
 Other
Pumping Level Below Land Surface
_____ ft. After _____ Hrs. pumped _____ GPM
_____ ft. After _____ Hrs. pumped _____ GPM
If pump installed, pump rate _____ GPM

RECEIVED
MAY 20 2008
WATER RIGHTS PROGRAM

SCREEN: Perforated pipe Manufactured
Diameter 3 IN Length 10 FEET
Material PVC
Slot Size .020 Set From 621 Feet to 631 Feet
Other information SET K Packer

REMARKS
DEWEY Burdock
8-11-18

WAS A PACKER OR SEAL USED? YES NO
If so, what material? 6" x 3" K Packer
Describe packer(s) and location? Packer SET AT 611

This well was drilled under license # 745
And this report is true and accurate.
Drilling firm Davis Drilling
Signature of License Representative: Stan Davis

DISINFECTION: Was well disinfected upon completion?
YES, How: _____
X NO, Why Not? NA

Signature of Well Owner or Equitable Property Holder:
Date: 5/5/08

Laboratory sent to for water quality analysis
Respic



SOUTH DAKOTA WATER WELL COMPLETION REPORT

Location NE 1/4 NW 1/4 Sec 32 Twp 65 Rg 1E
County Custer North

Please mark well location with an "X"

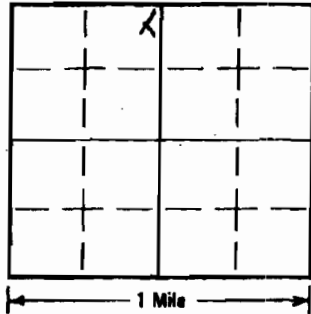

Well Completion Date

3-10-08

Well Owner: Powertech
Business Name: Powertech USA Inc.
Address: P.O. Box 773
Hot Springs SD 57747

WELL LOG:

FORMATION	DEPTH	
	FROM	TO
Skull Creek Shell	0	475
Fall River S.S.	475	505

LOCATION:

Distance from nearest potential pollution source (septic tank, abandoned well, feed lot, etc.)? None Present (identify source)

PROPOSED USE:

- Domestic/Stock
- Municipal
- Business
- Test Holes
- Irrigation
- Industrial
- Institutional
- Monitoring well

METHOD OF DRILLING:

Mud Rotary

CASING DATA: Steel Plastic Other

If other describe

PIPEWEIGHT	DIAMETER	FROM	TO	HOLE DIAMETER
SDR 17 LB/FT	6 IN	0 FT	490 FT	8 3/4 IN

GROUTING DATA

Grout Type	No. of Sacks	Grout Weight	From	To
CMT	107	15.2 lb./gal	0 ft	490 ft
		lb./gal	ft	ft

Describe grouting procedure

Pump

SCREEN: Perforated pipe Manufactured

Diameter 3 IN Length 15 FEET

Material

PVC

Slot Size 020 Set From 490 Feet to 505 Feet

Other information Set K Packer

WAS A PACKER OR SEAL USED? YES NO

If so, what material? 6" K Packer

Describe packer(s) and location? Packer set at 480'

DISINFECTION: Was well disinfected upon completion?

YES, How:

NO, Why Not?

NA

Laboratory sent to for water quality analysis

Respic

STATIC WATER LEVEL 0 Feet

If flowing: closed in pressure 6.5 PSI

GPM flow 6 through 2 inch pipe

Controlled by Valve Reducers Other

Reduced Flowrate _____ GPM

Can well be completely shut in? YES

WELL TEST DATA:

Pumped

Describe: A.I.L. DT 475'

Bailed

Other

Pumping Level Below Land Surface

ft. After _____ Hrs. pumped _____

ft. After _____ Hrs. pumped _____

If pump installed, pump rate _____

RECEIVED
APR - 1 2008
WATER RIGHTS PROGRAM
GPM

REMARKS

DEWEY Burdock
8-32-9c

This well was drilled under license # 745

And this report is true and accurate.

Drilling firm DAVIS Drilling INC

Signature of License Representative:

Stan Davis

Signature of Well Owner or Equitable Property Holder:

Powertech

Date: 3/10/08

7S

Hydro ID 692

SOUTH DAKOTA WATER WELL COMPLETION REPORT

1 of 1 07-92

4-16-08

Location NE 1/4 SW 1/4 Sec 11 Twp 65 Rg 1E
 County Fall River North

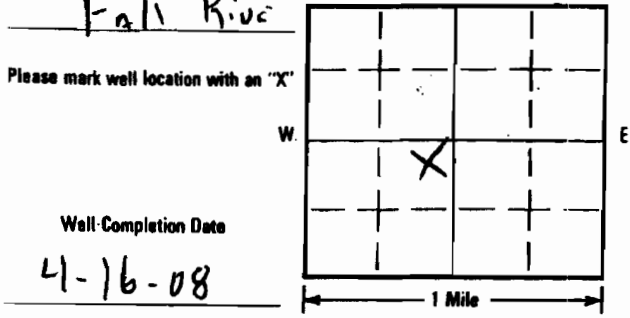

Please mark well location with an "X"

Well Completion Date
4-16-08

Well Owner: Power Tech
 Business Name: Power Tech USA INC
 Address: P.O. Box 723
Hot Springs S.D 57747

WELL LOG:

FORMATION	DEPTH	
	FROM	TO
<u>Skull Creek</u>	<u>0</u>	<u>125</u>
<u>Fall River</u>	<u>125</u>	<u>250</u>
<u>Fuson</u>	<u>250</u>	<u>325</u>
<u>Lakota</u>	<u>325</u>	<u>335</u>

LOCATION:
 Distance from nearest potential pollution source (septic tank, abandoned well, feed lot, etc.)? NONE Present ft. from Present (identify source).

PROPOSED USE:
 Domestic/Stock Municipal Business Test Holes
 Irrigation Industrial Institutional Monitoring well

METHOD OF DRILLING:
Mud & Rotary

CASING DATA: Steel Plastic Other
 If other describe _____

PIPEWEIGHT	DIAMETER	FROM	TO	HOLE DIAMETER
<u>SDR 17</u> LB/FT	<u>6</u> IN	<u>0</u> FT	<u>325</u> FT	<u>8 3/4</u> IN
_____ LB/FT	_____ IN	_____ FT	_____ FT	_____ IN
_____ LB/FT	_____ IN	_____ FT	_____ FT	_____ IN

STATIC WATER LEVEL 39.6 Feet
 If flowing: closed in pressure _____ PSI
 GPM flow _____ through _____ inch pipe
 Controlled by Valve Reducers Other _____
 Reduced Flowrate _____ GPM
 Can well be completely shut in? YES

GROUTING DATA
 Grout Type CMJ No. of Sacks 58 Grout Weight 15.2 lb./gal From 0 ft To 325 ft
 Describe grouting procedure pump

WELL TEST DATA:
 Pumped Describe: Airlift at 310
 Bailed _____
 Other _____
 Pumping Level Below Land Surface _____
 _____ ft. After _____ Hrs. pumped _____ GPM
 _____ ft. After _____ Hrs. pumped _____ GPM
 If pump installed, pump rate _____ GPM

SCREEN: Perforated pipe Manufactured
 Diameter 3 IN Length 10 FEET
 Material PVC
 Slot Size .020 Set From 325 Feet to 335 Feet
 Other information SET K Packer

REMARKS
DEWEY Burdock
8-11-19

WAS A PACKER OR SEAL USED? YES NO
 If so, what material? 6" X 3" K Packer
 Describe packer(s) and location? Packer Set at 315

This well was drilled under license # 745
 And this report is true and accurate.
 Drilling firm Davis Drilling
 Signature of License Representative: [Signature]

DISINFECTION: Was well disinfected upon completion?
 YES. How: _____
 NO. Why Not? NA
 Laboratory sent to for water quality analysis Rispel

Signature of Well Owner or Equitable Property Holder: [Signature]
 Date: 5/5/08
 RECEIVED
 MAY 20 2008
 WATER RIGHTS PROGRAM



SOUTH DAKOTA WATER WELL COMPLETION REPORT

Location NE 1/4 NW 1/4 Sec 32 Twp 6S Rg 1E
County CUSTER

Please mark well location with an "X"

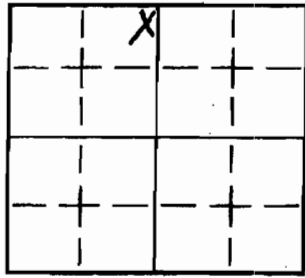

Well Completion Date

3-8-08

Well Owner: Power Tech
Business Name: Power Tech USA Inc
Address: P.O. Box 723
Hot Springs, S.D. 57747

FORMATION	DEPTH	
	FROM	TO
Shull Cragh Shale	0	475
Fall River S.S.	475	620
Fusion Shale	620	670
Lakota S.S.	670	765
Morrison Shale	765	865
UNKPAPA S.S.	865	910

RECEIVED
MAR 21 2008

LOCATION:
Distance from nearest potential pollution source (septic tank, abandoned well, feed lot, etc.)? _____ ft. from None Present (identify source).

PROPOSED USE:
 Domestic/Stock Municipal Business Test Holes
 Irrigation Industrial Institutional Monitoring well

METHOD OF DRILLING:
Mud Rotary

STATIC WATER LEVEL 0 Feet
If flowing: closed in pressure 55 PSI
GPM flow 2 through 2 inch pipe
Controlled by Valve Reducers Other
Reduced Flowrate _____ GPM
Can well be completely shut in? Yes

WATER RIGHTS PROGRAM

CASING DATA: Steel Plastic Other
If other describe _____
PIPEWEIGHT DIAMETER FROM TO HOLE DIAMETER
18 LB/FT 6 IN 0 FT 910 FT 8 3/4 IN

WELL TEST DATA:
 Pumped Describe: 1.1/1.1 AT 845'
 Bailed
 Other
Pumping Level Below Land Surface
_____ ft. After _____ Hrs. pumped _____ GPM
_____ ft. After _____ Hrs. pumped _____ GPM
If pump installed, pump rate _____ GPM

GROUTING DATA
Grout Type No. of Sacks Grout Weight From To
CMT 219 15.7 lb./gal 0 ft. 910 ft.
Describe grouting procedure Pump M&S cement

SCREEN: Perforated pipe Manufactured
Diameter 3 IN Length 20 FEET
Material PVC
Slot Size .020 Set From 910 Feet to 930 Feet
Other information Set to Packer

REMARKS
DEWEY Burdock 8-32-11

WAS A PACKER OR SEAL USED? YES NO
If so, what material? 6" h Packer
Describe packer(s) and location? Packer set 890'

This well was drilled under license # 745
And this report is true and accurate.
Drilling firm Davis Drilling Inc
Signature of License Representative: Stan Davis
Signature of Well Owner or Equitable Property Holder: PowerTech
Date: 3/13/08

DISINFECTION: Was well disinfected upon completion?
YES, How: _____
NO, Why Not? NA
Laboratory sent to for water quality analysis: Respec



SOUTH DAKOTA WATER WELL COMPLETION REPORT

Location NW 1/4 NW 1/4 Sec 15 Twp 7S Rg 1E
County Fall River North

Please mark well location with an "X"

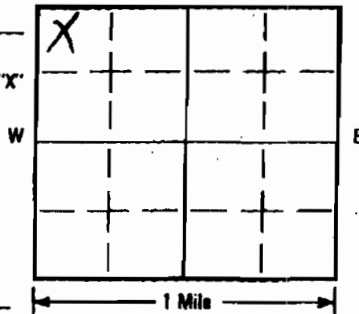

Well-Completion Date

3-22-08

Well Owner: Power Tech
Business Name: Power Tech USA INC
Address: P.O. Box 723
Hot Springs S.D. 57747

FORMATION	DEPTH	
	FROM	TO
Shull Creek Shale	0	295
Fall River S.S.	295	392

LOCATION:

Distance from nearest potential pollution source (septic tank, abandoned well, feed lot, etc.)? ft. from NONE Present (identify source).

PROPOSED USE:

- Domestic/Stock
- Municipal
- Business
- Test Holes
- Irrigation
- Industrial
- Institutional
- Monitoring well

METHOD OF DRILLING:

MUD + Rotary

CASING DATA:

- Steel
- Plastic
- Other

If other describe

PIPEWEIGHT	DIAMETER	FROM	TO	HOLE DIAMETER
SDR 17 LB/FT	6 IN	0 FT	377 FT	8 3/4 IN

GROUTING DATA

Grout Type	No. of Sacks	Grout Weight	From	To
CMG	59	15.2 lb./gal	0	377 ft

Describe grouting procedure pump

SCREEN:

- Perforated pipe
- Manufactured

Diameter 3 IN Length 15 FEET
Material PVC
Slot Size 020 Set From 377 Feet to 392 Feet
Other information Set K Packer

WAS A PACKER OR SEAL USED? YES NO

If so, what material? 6" x 4" N Packer 4" x 3" Bell
Describe packer(s) and location? Packer Set at 367'

DISINFECTION: Was well disinfected upon completion?

YES, How:
NO, Why Not? NA

Laboratory sent to for water quality analysis

Kespec

STATIC WATER LEVEL 0 Feet
If flowing: closed in pressure 7 PSI
GPM flow 2 through 2 inch pipe
Controlled by Valve Reducers Other
Reduced Flowrate GPM
Can well be completely shut in? YES

WELL TEST DATA:

Pumped Describe: Air Lift at 360'
 Bailed
 Other
Pumping Level Below Land Surface
ft. After Hrs. pumped
ft. After Hrs. pumped
If pump installed, pump rate

RECEIVED
APR 7 2008
WATER RIGHTS PROGRAM

REMARKS

DEWET Burdock
8-15-3

This well was drilled under license # 745

And this report is true and accurate.

Drilling firm Davis Drilling

Signature of License Representative: Stan Davis

Signature of Well Owner or Equitable Property Holder: Dan Isheng

Date: 4-1-08



SOUTH DAKOTA WATER WELL COMPLETION REPORT

SE

Hydro ID 695

Location S04 1/4 SE 1/4 Sec 32 Twp 6S Rg 1E
County CUSTER

Please mark well location with an "X"

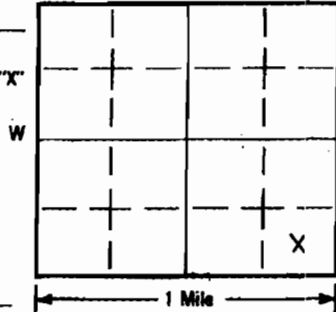

Well Completion Date

3-20-08

Well Owner: Power Tech
Business Name: Power Tech USA INC
Address: P.O. Box 723
Hot Springs SD 57747

FORMATION	DEPTH	
	FROM	TO
<u>Shull Creek Shale</u>	<u>0</u>	<u>415</u>
<u>Fall River S.S</u>	<u>415</u>	<u>508</u>

LOCATION:

Distance from nearest potential pollution source (septic tank, abandoned well, lead lot, etc.)? _____ ft. from HUNT POOL (identify source).

PROPOSED USE:

- Domestic/Stock Municipal Business Test Holes
 Irrigation Industrial Institutional Monitoring well

METHOD OF DRILLING:

Mud & Rotary

CASING DATA: Steel Plastic Other

If other describe _____

PIPEWEIGHT	DIAMETER	FROM	TO	HOLE DIAMETER
<u>SDB 17 LB/FT</u>	<u>6 IN</u>	<u>0 FT</u>	<u>493 FT</u>	<u>8 3/4 IN</u>
_____ LB/FT	_____ IN	_____ FT	_____ FT	_____ IN
_____ LB/FT	_____ IN	_____ FT	_____ FT	_____ IN

GROUTING DATA

Grout Type	No. of Sacks	Grout Weight	From	To
<u>CMT</u>	<u>106.4</u>	<u>15.1 lb./gal</u>	<u>0</u> ft.	<u>493</u> ft.
_____	_____	_____ lb./gal	_____ ft.	_____ ft.

Describe grouting procedure Pump

SCREEN: Perforated pipe Manufactured

Diameter 3 IN Length 15 FEET

Material PVC

Slot Size .020 Set From 493 Feet to 508 Feet

Other information Set K Packer

WAS A PACKER OR SEAL USED? YES NO

If so, what material? 6" x 4" N-Packer 4" x 3" ball

Describe packer(s) and location? Packer Set at 483'

DISINFECTION: Was well disinfected upon completion?

YES. How: _____

NO. Why Not? N/A

Laboratory sent to for water quality analysis

Raspic

STATIC WATER LEVEL 0 Feet
If flowing: closed in pressure 13 PSI
GPM flow 3 through 2 inch pipe
Controlled by Valve Reducers Other
Reduced Flowrate _____ GPM
Can well be completely shut in? Yes

WELL TEST DATA:

Pumped Describe: Air-lift AT 480'
 Bailed
 Other

Pumping Level Below Land Surface

_____ ft. After _____ Hrs. pumped _____ GPM

_____ ft. After _____ Hrs. pumped _____ GPM

If pump installed, pump rate _____

REMARKS

Dewey Burdock

8-32-13

This well was drilled under license # 745

And this report is true and accurate.

Drilling firm Davis Drilling

Signature of License Representative: Sta. Davis

Signature of Well Owner or Equitable Property Holder: [Signature]

Date: 4-1-08

RECEIVED
APR-7 2008
WATER RIGHTS PROGRAM



SOUTH DAKOTA WATER WELL COMPLETION REPORT

Location NW 1/4 NW 1/4 Sec 15 Twp 7S Rg 1E
County Fall River North

Well Owner: Powertech
Business Name: Powertech USA INC
Address: P.O. Box 723
Hot Springs S.D. 57747

Please mark well location with an "X"

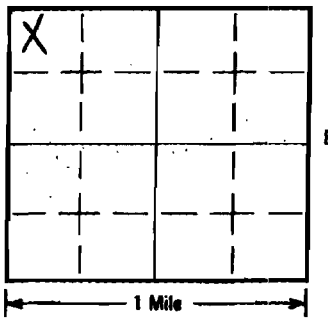

Well Completion Date

3-21-08

FORMATION	DEPTH	
	FROM	TO
Shull Creek Shale	0	295
Fall River s.s	295	425
Fuson Shale	425	475
Lakota	475	587

LOCATION:
Distance from nearest potential pollution source (septic tank, abandoned well, feed lot, etc.)? ft. from NONE Present (identify source).

PROPOSED USE:
 Domestic/Stock Municipal Business Test Holes
 Irrigation Industrial Institutional Monitoring well

METHOD OF DRILLING:
Mud & Rotary

CASING DATA: Steel Plastic Other

PIPEWEIGHT	DIAMETER	FROM	TO	HOLE DIAMETER
SDR 17 LB/FT	6 IN	0 FT	572 FT	8 3/4 IN
LB/FT	IN	FT	FT	IN
LB/FT	IN	FT	FT	IN

GROUT TYPE	No. of Sacks	Grout Weight	From	To
Cms	86	15.0 lb./gal	0	572
		lb./gal	ft	ft

Describe grouting procedure pump

SCREEN: Perforated pipe Manufactured
Diameter 3 IN Length 15 FEET
Material PVC
Slot Size .020 Set From 572 Feet to 587 Feet
Other information Set K Packer

WAS A PACKER OR SEAL USED? YES NO
If so, what material? 6" x 4" K Packer 4" x 3" bell
Describe packer(s) and location? Packer set at 562'

DISINFECTION: Was well disinfected upon completion?
YES, How: NA
X NO, Why Not? NA

Laboratory sent to for water quality analysis
Respec

STATIC WATER LEVEL 0 Feet
If flowing: closed in pressure 15 PSI
GPM flow 60 through 2 inch pipe
Controlled by Valve Reducers Other
Reduced Flowrate GPM
Can well be completely shut in? Yes

WELL TEST DATA:
 Pumped Describe: AIRLIFT AT 560
 Beited
 Other
Pumping Level Below Land Surface
ft. After Mrs. pumped APR - 7 2008 GPM
ft. After Mrs. pumped WATER RIGHTS PROGRAM GPM
If pump installed, pump rate GPM

REMARKS Dewey Burdock
8-15-2

This well was drilled under license # 745
And this report is true and accurate.
Drilling firm DAVIS Drilling
Signature of License Representative: Stan Davis
Signature of Well Owner or Equitable Property Holder: [Signature]
Date: 4-1-08



4-2-08

SE

Hydro ID 697

SOUTH DAKOTA WATER WELL COMPLETION REPORT

1 of 1 07-92

Location SW 1/4 SE 1/4 Sec 32 Twp 6S Rg 1E
County Custer North

Please mark well location with an "X"

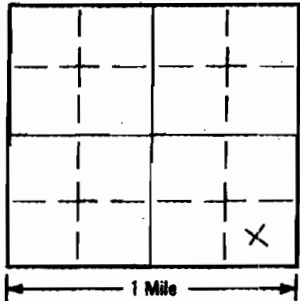

Well-Completion Date

3-18-08

Well Owner: Power Tech
Business Name: Power Tech USA INC
Address: P.O. Box 723
Hot Springs SD 57747

FORMATION	DEPTH	
	FROM	TO
Shull beach Shale	0	415
Fall River	415	550
Fuson Shale	550	635
Lakota S.L	635	682

LOCATION:

Distance from nearest potential pollution source (septic tank, abandoned well, feed lot, etc.)? ft. from NONE Present (identify source).

PROPOSED USE:

- Domestic/Stock
- Municipal
- Business
- Test Holes
- Irrigation
- Industrial
- Institutional
- Monitoring well

METHOD OF DRILLING:

MWD & Rebar

CASING DATA: Steel Plastic Other

If other, describe

PIPEWEIGHT	DIAMETER	FROM	TO	HOLE DIAMETER
SDR 17 LB/FT	6 IN	0 FT	667 FT	8 3/4 IN
LB/FT	IN	FT	FT	IN
LB/FT	IN	FT	FT	IN

GROUTING DATA

Grout Type	No. of Sacks	Grout Weight	From	To
CMG	112	13.0 lb./gal	0 ft	667 ft
		lb./gal	ft	ft

Describe grouting procedure: Pump, Bag Mix, Kelly Process

SCREEN: Perforated pipe Manufactured

Diameter 3 IN Length 15 FEET
Material PVC
Slot Size .020 Set from 667 Feet to 682 Feet
Other information Set h Packer

WAS A PACKER OR SEAL USED? YES NO

If so, what material? 6" x 4" K Packer 4" 13" bell
Describe packer(s) and location? Packer set at 657

DISINFECTED: Was well disinfected upon completion?

YES, How:
X NO, Why Not? NA

Laboratory sent to for water quality analysis

Respec

STATIC WATER LEVEL 0 Feet
If flowing: closed in pressure 40 PSI
GPM flow 30 through 2 inch pipe
Controlled by Valve Reducers Other
Reduced Flowrate _____ GPM
Can well be completely shut in? Yes

WELL TEST DATA:

Pumped Describe: Air lift at 650'
 Bailed
 Other
Pumping Level Below Land Surface
ft. After _____ Hrs. pumped _____ GPM
ft. After _____ Hrs. pumped _____ GPM
If pump installed, pump rate _____ GPM

RECEIVED
APR - 7 2008
WATER RIGHTS
PROGRAM

REMARKS

Dewey Burdock
S-32-12

This well was drilled under license # 745

And this report is true and accurate.

Drilling firm Davis Drilling Inc

Signature of License Representative: [Signature]

Signature of Well Owner or Equitable Property Holder: [Signature]

Date: 4-1-08



Hydro ID 698

SOUTH DAKOTA WATER WELL COMPLETION REPORT

1 of 1 07-92

Location SW 1/4 NE 1/4 Sec 2 Twp 75 Rg 1E
County Fall River North

Please mark well location with an "X"

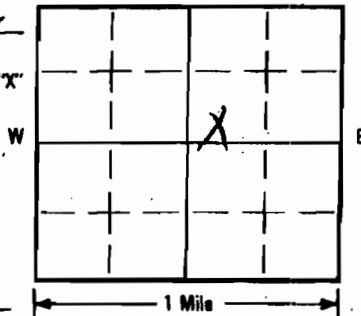

Well-Completion Date

3-25-08

Well Owner: POWER TECH
Business Name: POWER TECH USA INC.
Address: P.O. Box 723
Hot Springs S.D. 57747

FORMATION	DEPTH	
	FROM	TO
Shull Creek Shale	0	75
Fall River S.S.	75	205

LOCATION:
Distance from nearest potential pollution source (septic tank, abandoned well, feed lot, etc.)? _____ ft. from NONE Present (identify source).

PROPOSED USE:
 Domestic/Stock Municipal Business Test Holes
 Irrigation Industrial Institutional Monitoring well

METHOD OF DRILLING:
Mud & Rotary

CASING DATA: Steel Plastic Other
If other describe _____
PIPEWEIGHT DIAMETER FROM TO HOLE DIAMETER
SDR 21 LB/FT 6 IN 0 FT 180 FT 8 1/4 IN
____ LB/FT ____ IN ____ FT ____ FT ____ IN
____ LB/FT ____ IN ____ FT ____ FT ____ IN

GROUTING DATA
Grout Type No. of Sacks Grout Weight From To
CMT 35 15.6 lb./gal 0 ft 180 ft
____ lb./gal ____ ft ____ ft
Describe grouting procedure pump

SCREEN: Perforated pipe Manufactured
Diameter 3 IN Length 25 FEET
Material PVC
Slot Size .020 Set From 190 Feet to 205 Feet
Other information Set K Packers

WAS A PACKER OR SEAL USED? YES NO
If so, what material? 6" x 3" K Packers
Describe packer(s) and location? Packers set at 170'

DISINFECTION: Was well disinfected upon completion?
YES, How: _____
NO, Why Not? NA

Laboratory sent to for water quality analysis
Respec

STATIC WATER LEVEL 34.36 Feet
If flowing: closed in pressure _____ PSI
GPM flow _____ through _____ inch pipe
Controlled by Valve Reducers Other _____
Reduced Flowrate _____ GPM
Can well be completely shut in? Yes

WELL TEST DATA:
 Pumped Describe: Adjust AT 165'
 Bailed
 Other
Pumping Level Below Land Surface
____ ft. After ____ Hrs. pumped ____ GPM
____ ft. After ____ Hrs. pumped ____ GPM
If pump installed, pump rate _____ GPM

REMARKS Dewey Burdock
8-2-1

This well was drilled under license # 745
And this report is true and accurate.
Drilling firm DAU's Drilling
Signature of License Representative: Stan Davis
Signature of Well Owner or Responsible Property Holder: _____
Date: 4/28/08

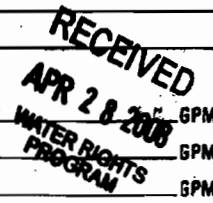



414-08

Hydro ID 703

SOUTH DAKOTA WATER WELL COMPLETION REPORT

1 of 1 07-92

Location SW 1/4 SW 1/4 Sec 1 Twp 75 Rg 1E
County Fall River North

Well Owner: Power Tech
Business Name: Power Tech USA Inc
Address: P.O. Box 723
Hot Springs S.D. 57747

Please mark well location with an "X"

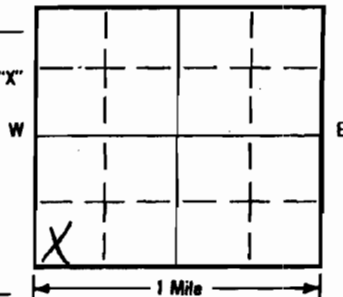

Well Completion Date
4-18-08

WELL LOG:	DEPTH	
	FROM	TO
Fall River	0	100
Fusow	100	150
Leahula	150	305
Mission	305	410
UNK PAPA	410	525

LOCATION:
Distance from nearest potential pollution source (septic tank, abandoned well, feed lot, etc.)? 200 ft. from Septic Tank (identify source).

PROPOSED USE:
 Domestic/Stock Municipal Business Test Holes
 Irrigation Industrial Institutional Monitoring well

METHOD OF DRILLING:
Mud & Rotary

STATIC WATER LEVEL 110 Feet
If flowing: closed in pressure _____ PSI
GPM flow _____ through _____ inch pipe
Controlled by Valve Reducers Other _____
Reduced Flowrate _____ GPM
Can well be completely shut in? YES

CASING DATA: Steel Plastic Other
If other describe _____
PIPEWEIGHT DIAMETER FROM TO HOLE DIAMETER
18 LB/FT 6 IN 0 FT 475 FT 8 1/4 IN

WELL TEST DATA:
 Pumped Describe: A lift at 410
 Bailed
 Other
Pumping Level Below Land Surface
_____ ft. After _____ Hrs. pumped _____ GPM
_____ ft. After _____ Hrs. pumped _____ GPM
If pump installed, pump rate _____ GPM

GROUTING DATA
Grout Type No. of Sacks Grout Weight From To
C-25 92 15.3 lb./gal 0 ft 475 ft
Describe grouting procedure pump

REMARKS DEWEY Burdock
8-1-7

SCREEN: Perforated pipe Manufactured
Diameter 3 IN Length 50 FEET
Material PVC
Slot Size .020 Set From 475 Feet to 525 Feet
Other information SET to Pack-

This well was drilled under license # 745
And this report is true and accurate.
Drilling firm Davis Drilling, Inc
Signature of License Representative: Stan Davis
Signature of Well Owner or Equitable Property Holder:
Date: 5/5/08

WAS A PACKER OR SEAL USED? YES NO
If so, what material? 6" x 3" K Packer
Describe packer(s) and location? Packer SET at 465'

DISINFECTION: Was well disinfected upon completion?
YES, How: _____
X NO, Why Not? NA
Laboratory sent to for water quality analysis
Respic

5-10-08



SOUTH DAKOTA WATER WELL COMPLETION REPORT

Location NW 1/4 NW 1/4 Sec 5 Twp 7S Rg 1E
County Fall River North

Please mark well location with an "X"

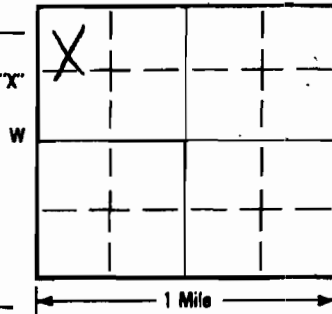

Well Completion Date
4-29-08

Well Owner: Power Tech
Business Name: Power Tech USA INC
Address: P.O. Box 723
Hot Springs S.D. 57747

FORMATION	DEPTH	
	FROM	TO
Skull Creek	0	455
Fall River	455	600
Fuson	600	655
Lakota	655	735
Morrison	735	890
UNH PAPER	890	955

LOCATION:
Distance from nearest potential pollution source (septic tank, abandoned well, feed lot, etc.)? _____ ft. from NONE Present (identify source).

PROPOSED USE:
 Domestic/Stock Municipal Business Test Holes
 Irrigation Industrial Institutional Monitoring well

METHOD OF DRILLING:
Mud & Rotary

CASING DATA: Steel Plastic Other

PIPEWEIGHT	DIAMETER	FROM	TO	HOLE DIAMETER
18 LB/FT	6 IN	0 FT	915 FT	8 3/4 IN
_____ LB/FT	_____ IN	_____ FT	_____ FT	_____ IN
_____ LB/FT	_____ IN	_____ FT	_____ FT	_____ IN

GROUTING DATA
Grout Type: CMT No. of Sacks: 203 Grout Weight: 153 lb./gal From: 0 ft To: 915 ft
Describe grouting procedure: M & S Cementing

SCREEN: Perforated pipe Manufactured
Diameter: 3" IN Length: 40 FEET
Material: PVC
Slot Size: .020 Set From: 915 Feet to: 955 Feet
Other information: 5/2 K Packer

WAS A PACKER OR SEAL USED? YES NO
If so, what material? 3' x 6" K Packer
Describe packer(s) and location? Packer Set 905

DISINFECTION: Was well disinfected upon completion?
YES, How: _____
NO, Why Not? NA
Laboratory sent to for water quality analysis: Respec

STATIC WATER LEVEL: 0 Feet
If flowing: closed in pressure: 42 PSI
GPM flow: 1/2 through 2 inch pipe
Controlled by: Valve Reducers Other
Reduced Flowrate: _____ GPM
Can well be completely shut in? YES

WELL TEST DATA:
 Pumped Describe: A. 1/2 at 900'
 Bailed
 Other
Pumping Level Below Land Surface: _____ ft. _____ GPM
_____ ft. _____ GPM
If pump installed, pump rate: _____ GPM

REMARKS: DEWEY Burdock
8-5-1

This well was drilled under license # 745
And this report is true and accurate.
Drilling firm: DAVID Drilling Inc
Signature of License Representative: Stan Davis
Signature of Well-Owner or Equitable Property Holder: _____
Date: 5/2/08



Hydro ID 705

SOUTH DAKOTA WATER WELL COMPLETION REPORT

07-92

Location NE 1/4 NE 1/4 Sec 21 Twp 65 Rg 1E
County Custer North

Please mark well location with an "X"

Well Completion Date

12-5-09

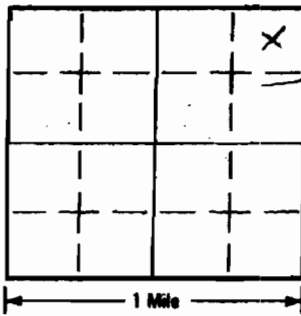

Well Owner: Powertech
Business Name: Powertech USA Inc
Address: P.O. Box 723
Hot Springs S.D. 57747

FORMATION	DEPTH	
	FROM	TO
skull Creek	0	150
Fall River	150	328
Lakota (Fusion + Johnson)	328	480
Morrison	480	550
Dark sand	550	600

LOCATION:
Distance from nearest potential pollution source (septic tank, abandoned well, feed lot, etc.)? _____ ft. from NONE present (Identify source).

PROPOSED USE:
 Domestic/Stock Municipal Business Test Holes
 Irrigation Industrial Institutional Monitoring well

METHOD OF DRILLING: MUD Rotary
SS 2200

CASING DATA: Steel Plastic Other

PIPEWEIGHT	DIAMETER	FROM	TO	HOLE DIAMETER
SDR 17 LB/FT	6 IN	0 FT	428 FT	8 3/4 IN
LB/FT	IN	FT	FT	IN
LB/FT	IN	FT	FT	IN

GROUTING DATA
Grout Type: CMT No. of Sacks: 80 Grout Weight: 15.1 lb./gal From: 0 ft To: 428 ft
Describe grouting procedure: PUMP

SCREEN: Perforated pipe Manufactured
Diameter: 3 IN Length: 30 FEET
Material: PVC
Slot Size: .020 Set From: 428 Feet to: 458 Feet
Other information: 10 Blank 418-428

WAS A PACKER OR SEAL USED? YES NO
If so, what material? K-Packer
Describe packer(s) and location? SET AT 418

DISINFECTED: Was well disinfected upon completion?
 YES, How: Bleach 1 gallon
 NO, Why Not?

STATIC WATER LEVEL: 115 Feet
If flowing: closed in pressure _____ PSI
GPM flow _____ through _____ inch pipe
Controlled by Valve Reducers Other
Reduced Flowrate _____ GPM
Can well be completely shut in?

WELL TEST DATA:
 Pumped Describe: Air lift at 410' 5 GPMs
 Bailed
 Other
Pumping Level Below Land Surface
_____ ft. After _____ Hrs. pumped _____ GPM
_____ ft. After _____ Hrs. pumped _____ GPM
If pump installed, pump rate _____ GPM

REMARKS
* Well Was Overdrilled *
* Set CMT plug 460-600 *
Dewey Burdock 9-21-1

This well was drilled under license # 745
And this report is true and accurate.
Drilling firm: Davis Drilling Inc.
Signature of License Representative: Stan Davis
Signature of Well Owner or Equitable Property Holder: _____
Date: 12/15/09
RECEIVED
DEC 28 2009
WATER RIGHTS PROGRAM



Hydro ID 706

SOUTH DAKOTA WATER WELL COMPLETION REPORT

1 of 1 07-92

Location NE 1/4 NE 1/4 Sec 21 Twp 6S Rg 1E
County CUSTER North

Please mark well location with an "X"

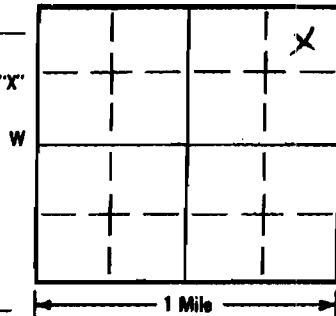

Well Completion Date

12 5. 09

Well Owner: PowerTech
Business Name: PowerTech USA Inc
Address: P.O. Box 723
Hot Springs S.D. 57717

FORMATION	DEPTH	
	FROM	TO
Shull Creek	0	150
Fall River	150	316
Kahela (Ferguson)	316	328

LOCATION:

Distance from nearest potential pollution source (septic tank, abandoned well, feed lot, etc.)? ft. from NONE PRESENT (identify source).

PROPOSED USE:

- Domestic/Stock
- Municipal
- Business
- Test Holes
- Irrigation
- Industrial
- Institutional
- Monitoring well

METHOD OF DRILLING:

Mud Rotary
SS 2200

CASING DATA: Steel Plastic Other

If other describe

PIPEWEIGHT	DIAMETER	FROM	TO	HOLE DIAMETER
5.2 LB/FT	6 IN	0 FT	284 FT	8 3/4 IN
LB/FT	IN	FT	FT	IN
LB/FT	IN	FT	FT	IN

GROUTING DATA

Grout Type	No. of Sacks	Grout Weight	From	To
CMT	56	15.1 lb./gal	0 ft.	284 ft.
		lb./gal	ft.	ft.

Describe grouting procedure PUMP

SCREEN: Perforated pipe Manufactured

Diameter 3 IN Length 30 FEET

Material PVC

Slot Size .020 Set From 284 Feet to 314 Feet

Other information 10' Blank 274-284

WAS A PACKER OR SEAL USED? YES NO

If so, what material? K-Packer

Describe packer(s) and location? SET AT 274'

DISINFECTATION: Was well disinfected upon completion?

YES, How: BLEACH 1 gallon
 NO, Why Not?

STATIC WATER LEVEL 110 Feet

If flowing: closed in pressure PSI

GPM flow through inch pipe

Controlled by Valve Reducers Other

Reduced Flowrate GPM

Can well be completely shut in?

WELL TEST DATA:

- Pumped Describe: Artificial at 274'
- Bailed
- Other

Pumping Level Below Land Surface

ft. After Hrs. pumped GPM

ft. After Mrs. pumped GPM

If pump installed, pump rate GPM

REMARKS

DEWEY Burdock 9-21-2

This well was drilled under license # 745

And this report is true and accurate.

Drilling firm Davis Drilling Inc

Signature of License Representative: Stan Davis

Signature of Well Owner/Available Property Holder:

Date: 12/15/09

RECEIVED

DEC 28 2009

WATER RIGHTS PROGRAM



Hydro ID 707

NE

SOUTH DAKOTA WATER WELL COMPLETION REPORT

Location 1/4 NW 34 Sec 34 Twp 6S Rg 1E

Well Owner: ...
Business Name: Powertech, Inc.
Address: 145 N Chicago Street
City, State, Zip: Hot Springs SD 57747

County Custer County

North

Please mark well location with an "X"

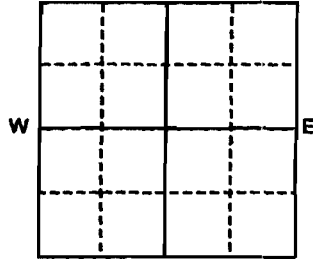

Well Completion Date

May 5, 2011



Distance to nearest potential pollution source (septic tank, abandoned well, feed lot, etc.)?
ft. from Unknown (Identify source)

PROPOSED USE:

- Domestic/Stock Irrigation, Municipal Industrial, Business Institutional, Test holes Monitoring well

METHOD OF DRILLING:

3.25" HSA to 40.0'

4.25" HSA?

4.25"?

CASING DATA:

- Steel, Plastic, Other

If other describe

Table with columns: PIPEWEIGHT, DIAMETER, FROM, TO, HOLE DIAMETER

GROUTING DATA:

Table with columns: Grout Type, No. of Sacks, Grout Weight, From, To

Describe grouting procedure

SCREEN:

- Perforated pipe, Manufactured

Diameter 2.00 Inches Length 10.0 Feet

Material Sch 40 PVC

Slot Size 0.010" Set From 30.0 Feet to 40.0 Feet

Other information 12-20 Silica Sand from 28' to 40'

WAS A PACKER OR SEAL USED?

- Yes, No

If so, what material?

Describe packer(s) and location

DISINFECTION: Was well disinfected upon completion?

- Yes, How?

Lab to which water quality sample sent for analysis

WELL LOG:

Table with columns: FORMATION, DEPTH (FROM, TO)

STATIC WATER LEVEL

FEET

If flowing: closed in pressure

PSI

GPM flow

through

Inch pipe

Controlled by

- Valve, Reducers, Other

Reduced flow rate

GPM

Can well be completely shut in?

RECEIVED

WELL TEST DATA:

- Pumped Describe: NA, Bailed, Other

NOV 09 2011

WATER RIGHTS PROGRAM

Pumping Level Below Land Surface

Ft. After Hrs. pumped GPM

Ft. After Hrs. pumped GPM

If pump installed, pump rate:

GPM

REMARKS

Monitoring well 11-34-4

This well was drilled under license # 678 and this report is true and accurate.

Drilling firm: American Engineering Testing, Inc.

Signature of License Representative:

Handwritten signature

Signature of Well Owner or Equitable Property Holder:

Date:

SOIL BORING AND MONITORING WELL LOG

Hydro ID 707
 JB NO. 17-124 VERTICAL SCALE 1" = 5' BORING NO. 11-24-4 WELL NO. 2 of 3 MW-11-24-4
 PROJECT POWER TECH

Boring No.	Date	Time
Boring Started	<u>5-5-11</u>	<u>10:55</u>
Boring Completed	<u>11</u>	<u>15:00</u>
Finished		
Pulling Casing	<u>NA</u>	<u>NA</u>
Boring Filled		<u>NA</u>
Depth to Frost		

Method of Advancing Boring

Continuous Sampling From To

In. Flite-Auger To

3 1/4 In. Hollow Stem Auger to 40

In. Casing To

In. Casing To

P. D. or C. O. Tube From To

Jet With Water From To

c with Drilling Mud From To

Remarks

State Plane NAD 27

441813 1032064

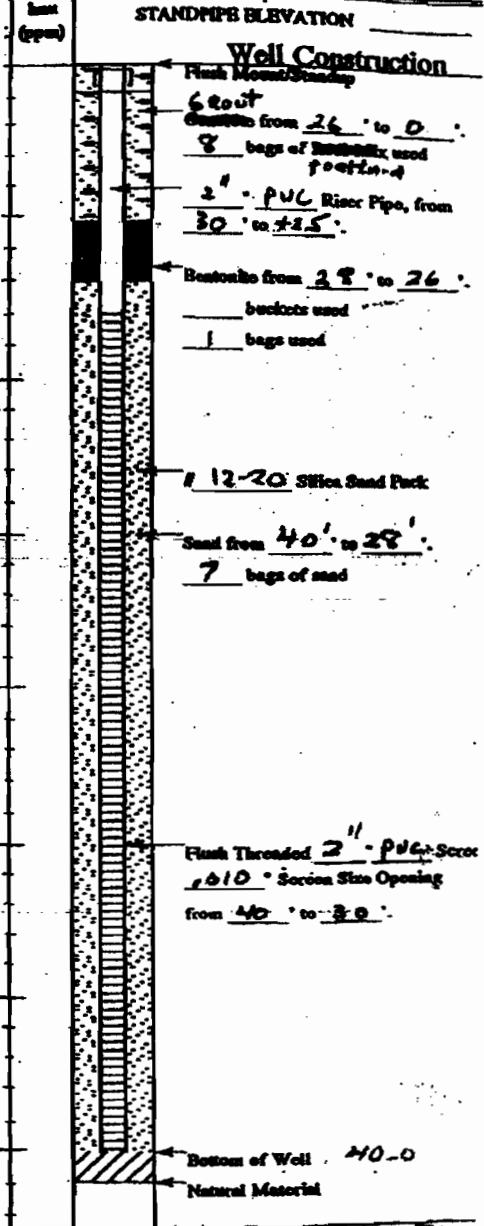

WATER LEVEL MEASUREMENTS						START <u>10:55</u>	COMPLETE <u>15:00</u>
DATE	TIME	SAMPLED DEPTH	CASING DEPTH	WATER LEVEL	WATER ELEVATION	METHOD <u>4 1/2\"/> </u>	
CREW CHIEF/LOGGER:						<u>NA</u>	



GEOTECHNICAL FIELD DATA SHEET

Project Number: 17-1211 Date: 5-5-11 Boring Number: 11-34-4
 Project Location: DEWEY Crew Chief: BTB
 Boring Start Time: 10:55 Boring Completion Time: 15:00

Data Reviewed by:

Depth of Sample	Sample No./Depth	Soil Description	Classification
-0.5'	1	Topsoil - silty sand and moist organic (SM)	
-5'	1	Silty sand - Reddish Brown Dry (SM)	
12.0'	1	Silt/clayey silt with moist c.	
21.0'	1	Silty sand/clay - L+H	
	1	MOIST to WET @ 35.0' (SM)	
	1	EOB 40.0'	
	1	set well	
	1	1-10' SL	
	1	3-10' R	
	1	1-5' R	
	1	7 bags sand 2-20	
	1	1 bag Brit chips	

Method of Advancing Boring

Continuous Sampling From: _____ To: _____

_____ in. Flite Auger To: _____

4 1/2 in. Hollow Stem Auger To: 40

Jet With Drilling Mud From: _____ To: _____

Water Level Checks After Completion of Boring

	Date	Time	Casing In Grnd	W.L.	Cav
At Completion	5-5-11	0:55	-	32	3'
1 st Recheck					
2 nd Recheck					

Additional space

PG GEOT 0004 1/04



Hydro ID 708

11-02

SW

SOUTH DAKOTA WATER WELL COMPLETION REPORT

Location $\frac{1}{4}$ NW $\frac{1}{4}$ Sec 34 Twp 6S Rg 1E

Fall River
County Custer County

Please mark well location with an "X"

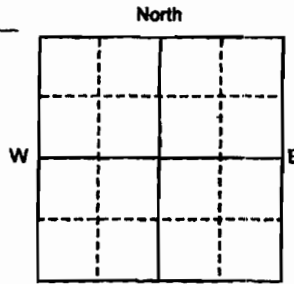

May 4, 2011

Well Completion Date

May 5, 2011

1 Mile

Distance to nearest potential pollution source (septic tank, abandoned well, feed lot, etc.)?
ft. from Unknown (Identify source)

PROPOSED USE:

- Domestic/Stock Irrigation
- Municipal Industrial
- Business Institutional
- Test holes Monitoring well

METHOD OF DRILLING:

4.25" HSA to 22.0' ← 30'

CASING DATA:

Steel Plastic Other

If other describe _____

PIPEWEIGHT DIAMETER FROM TO HOLE DIAMETER

LB/FT 2.00 IN 0.0 FT 22.0 FT 4.25 IN

LB/FT _____ IN _____ FT _____ FT _____ IN

LB/FT _____ IN _____ FT _____ FT _____ IN

GROUTING DATA:

Grout Type No. of Sacks Grout Weight From To

Cement 1 Lb/gal 0.0 FT 8.0 FT

Bentonite 1 Lb/gal 0.0 FT 10.0 FT

Describe grouting procedure

0 to 15 ft

15 to 20 ft

SCREEN:

Perforated pipe Manufactured

Diameter 2.00 Inches Length 10.0 Feet

Material Sch 40 PVC

Slot Size 0.010" Set From 12.0 Feet to 22.0 Feet ← 20 to 30 Feet

Other information 12-20 Silica Sand from 10' to 22' ← 20 to 30 Feet

WAS A PACKER OR SEAL USED? Yes No

If so, what material?

Describe packer(s) and location

DISINFECTION: Was well disinfected upon completion?

Yes, How?

Lab to which water No, Why Not? Monitoring well only.

quality sample sent for analysis

Well Owner: ...

Business Name: Powertech, Inc.

Address: 145 N Chicago Street

City, State, Zip: Hot Springs SD 57747

WELL LOG:

FORMATION	DEPTH	
	FROM	TO
Topsoil - Silty Lean Clay with sand, brown, moist (CL)	0	0.5'
Silty Lean Clay with sand, brn (CL)	0.5'	20'
Silty Gravel with sand, brn, wet (GM)	20'	22'

sl silty CLAY, dry, roots 0 - 22'
silty, sandy, clayey, GRAVEL, wet 22-28'
competent SHALE 28-30'

STATIC WATER LEVEL

_____ FEET

If flowing: closed in pressure _____ PSI

UPM flow _____ through _____ Inch pipe

Controlled by Valve Reducers Other _____

Reduced flow rate _____ GPM

Can well be completely shut in?

WELL TEST DATA:

Pumped Describe: NA

Bailed

Other

Pumping Level Below Land Surface

_____ Ft. After _____ Hrs. pumped _____ GPM

_____ Ft. After _____ Hrs. pumped _____ GPM

If pump installed, pump rate: _____ GPM

REMARKS

Monitoring well 11-3-2 ← 11-3-3

← 20 to 30 Feet

This well was drilled under license # 678 and this report is true and accurate.

Drilling firm: American Engineering Testing, Inc.

Signature of License Representative: *[Signature]*

Signature of Well Owner or Equitable Property Holder:

Date:

RECEIVED
NOV 09 2011
WATER RIGHTS PROGRAM



SOIL BORING AND MONITORING WELL LOG

Hydro ID 708
 JOB NO. 17-12-11 VERTICAL SCALE 1" = 5' BORING NO. 11-3-3 WELL NO. 11-3-3 2 of 3
 PROJECT power tech

Boring No.	Date	Time
Boring Started	<u>5-4-11</u>	<u>10:55</u>
Boring Completed	<u>11</u>	<u>15:00</u>
Finished	<u>NA</u>	<u>NA</u>
Pulling Casing	<u>NA</u>	<u>NA</u>
Boring Filled		<u>NA</u>
Depth to Frost		

STANDPIPE ELEVATION

Well Construction

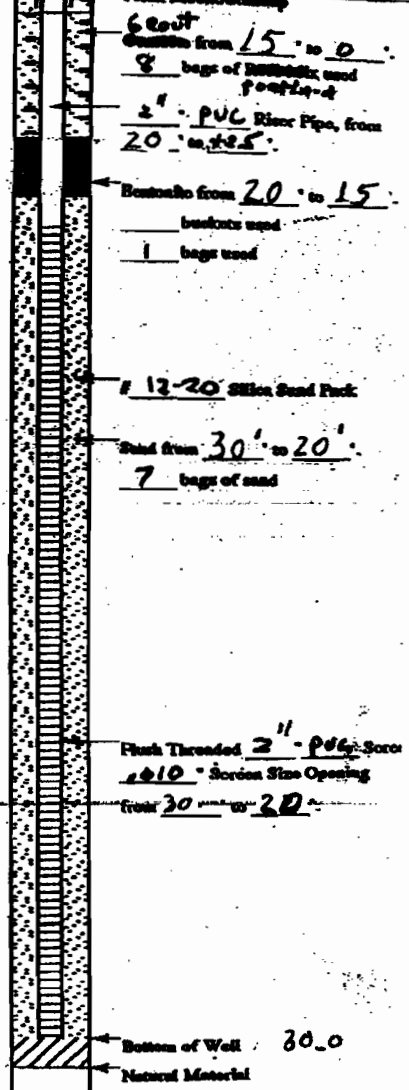

Method of Advancing Boring

Continuous Sampling From _____ To _____
 In. Flite-Auger To _____
3/4 In. Hollow Stem Auger to 30
 In. Casing To _____
 In. Casing To _____
 P. D. or C. O. Tube From _____ To _____
 Jet With Water From _____ To _____
 with Drilling Mud From _____ To _____

Remarks

State Plane NAD 27
N 434098 E ~~120~~ 1030383

WATER LEVEL MEASUREMENTS

DATE	TIME	SAMPLED DEPTH	CASING DEPTH	WATER LEVEL	WATER ELEVATION	METHOD	START	COMPLETE
						<u>3/4" BEA to 30'</u>	<u>10:55</u>	<u>15:00</u>

CREW CHIEF/LOGGER: AK



PowerTech (USA) Inc.

DRILLED WITH: AIR WATER HOLE NO. DB11-3-ALLUV-3

T.D. 30 LOCATION: 434097.55, 1039 532.506 State Plane NAD27

BIT SIZE 4" FA

SAMPLE LOG BY LE LEASE: (PROJECT) Dewey Burdock

DATE 5/4/11 COUNTY Fall River STATE SD

DEPTH	LITHOLOGY	CARBON	PYRITE	Alteration %	SAMPLE DESCRIPTION		T = Trace						
					L= Limonite (Lmn)	(Amounts in Percent, %)	1 = Minor	2 = Moderate	3 = Abundant				
					SOX Surf. Oxidation	POX = Primary Oxid.	BROX = Base of Surf. Oxid.	ZOX = Secondary Oxid.	Tn = Transition Zone	fd = Feldspar			
					Rd. Reduced								
					Rdt. Reduction								
					P = Pyrite (Pyr)								
					Pt = Pyrite Terminus								
0-22'													
10													
20													
22-28'													
30													
28'-30'													
40													
50													
60													

SOUTH DAKOTA WATER WELL COMPLETION REPORT

11-02

Location $\frac{1}{4}$ NW $\frac{1}{4}$ Sec 34 Twp 66 Rg 1E

Fall River

County Custer County

Please mark well location with an "X"

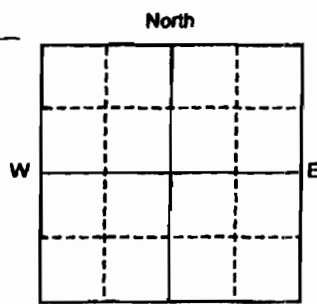

Well Completion Date

May 9, 2011



Distance to nearest potential pollution source (septic tank, abandoned well, feed lot, etc.)? Unknown ft. from (Identify source)

PROPOSED USE:

- Domestic/Stock Irrigation
 Municipal Industrial
 Business Institutional
 Test holes Monitoring well

METHOD OF DRILLING:

4.25" HSA to 38.0'

CASING DATA:

Steel Plastic Other

If other describe 28 FT

PIPEWEIGHT LB/FT	DIAMETER IN	FROM FT	TO FT	HOLE DIAMETER IN
	2.00	0.0	38.0	4.25

GROUTING DATA:

Grout Type	No. of Sacks	Grout Weight Lb/gal	From FT	To FT
Cement	7		0.0	24.0
Bentonite	1		24.0	28.0

Describe grouting procedure

26 to 28 Ft

SCREEN:

Perforated pipe Manufactured

Diameter 2.00 Inches Length 10.0 Feet

Material Sch 40 PVC

Slot Size 0.010" Set From 28.0 Feet to 38.0 Feet

Other information 12-20 Silica Sand from 26' to 38' ← 28 to 38'

WAS A PACKER OR SEAL USED? Yes No

If so, what material?

Describe packer(s) and location

DISINFECTION: Was well disinfected upon completion?

Yes, How?

Lab to which water quality sample sent for analysis No. Why Not? Monitoring well only.

Well Owner: ...

Business Name: Powertech, Inc.

Address: 145 N Chicago Street

City, State, Zip: Hot Springs SD 57747

WELL LOG:

FORMATION	DEPTH	
	FROM	TO
Topsoil - Silty Lean Clay with sand, brown, moist (CL)	0	0.5'
Silty Lean Clay with sand, brn (CL)	0.5'	35'
Silty Gravel with sand, brn, wet (GM)	35'	38'

STATIC WATER LEVEL

If flowing: closed in pressure _____ PSI
 GPM flow _____ through _____ Inch pipe
 Controlled by Valve Reducers Other _____
 Reduced flow rate _____ GPM
 Can well be completely shut in? _____

WELL TEST DATA:

Pumped Describe: NA
 Bailed
 Other
 Pumping Level Below Land Surface
 _____ Ft. After _____ Hrs. pumped _____ GPM
 _____ Ft. After _____ Hrs. pumped _____ GPM
 If pump installed, pump rate: _____ GPM

RECEIVED

NOV 09 2011

WATER RIGHTS PROGRAM

REMARKS

Monitoring well 11-15-4

This well was drilled under license # 678 and this report is true and accurate.

Drilling firm: American Engineering Testing, Inc.

Signature of License Representative:

Signature of Well Owner or Equitable Property Holder:

Date:



SOIL BORING AND MONITORING WELL LOG

NO. 17-1211 VERTICAL SCALE 1" = 5' BORING NO. SB- WELL NO. 2 MW-
 Hydro ID 709 PROJECT powertech 11-15-4 11-15-4

Boring No.	Date	Time
Boring Started	<u>5-9-11</u>	<u>7:15</u>
Boring Completed	<u>11</u>	
Finished		
Pulling Casing	<u>11</u>	<u>12:30</u>
Boring Filled		
Depth to Frost		

Method of Advancing Boring

Continuous Sampling From To

 In. Flite-Auger To

4 1/4 In. Hollow Stem Auger to 38.0

 In. Casing To

 In. Casing To

P. D. or C. O. Tube From To

Jet With Water From To

at with Drilling Mud From To

Remarks State Plane NAD 27
N 426 607 E 1029 415

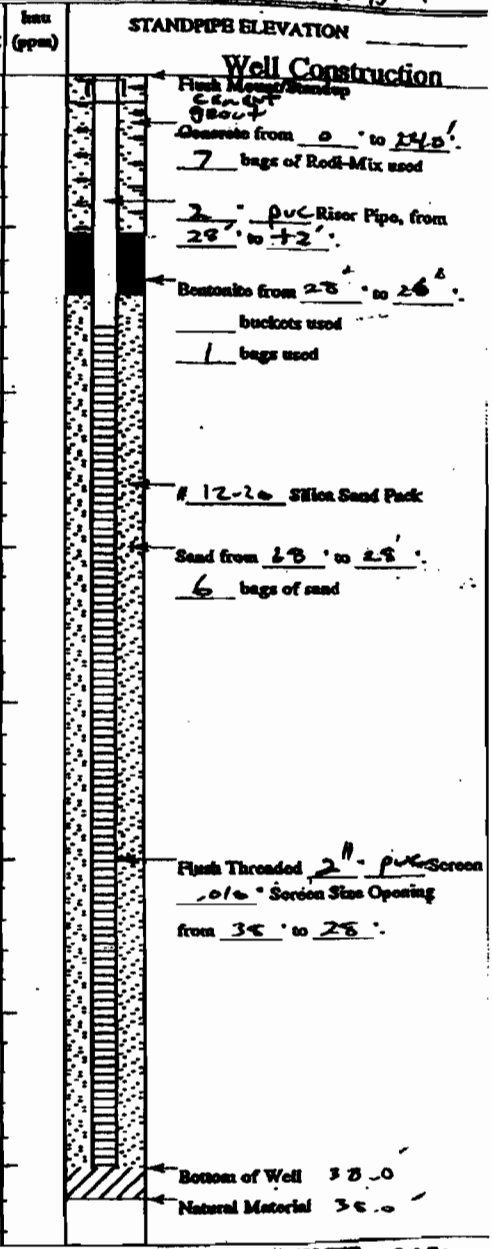

WATER LEVEL MEASUREMENTS						START	COMPLETE
DATE	TIME	SAMPLED DEPTH	CASING DEPTH	WATER LEVEL	WATER ELEVATION		
						<u>9:25</u>	<u>12:30</u>
METHOD <u>4 1/4 HSA to</u>							
CREW CHIEF/LOGGER: <u> </u>							



PowerTech (USA) Inc.

DRILLED WITH: AIR WATER HOLE NO. DA15-ALLUV-4

T.D. 40' LOCATION: 426606.639, 102944.805 State Plane NAD27

BIT SIZE 4" FA

SAMPLE LOG BY LE LEASE: (PROJECT) Dewey Burdock

DATE 5/4/11 COUNTY Fall River STATE SD

DEPTH	LITHOLOGY	Alteration %	SAMPLE DESCRIPTION		T = Trace		
			(Amounts in Percent, %)		1 = Minor	2 = Moderate	3 = Abundant
			L = Limestone (Lm) SOX Surf Oxidation Rd. Reduced Rd. Reduction P = Pyrite (Pyr) Pt = Pyrite Ternish	POX = Primary Oxid. SOX = Base of Surf. Oxid. SOX = Secondary Oxid. Tz = Transition Zone Fd = Feldspar	C = Carbon K = Kaolin	S = Bleached Ch = Chert	
0-35'			silty, sandy, CLAY, lt-med brown, dry, scat roots, (Mw)				
35-40'			silty, sandy, clayey, GRAVEL, med brown, quartzite & chert pebbles, wet, (Akw)				
			weathered GRANITE @ 40' = TD				
			* hole drilled out to 8" w/ 4" HSA & converted to MW.				



380-2

No.

**Office of State Engineer
DOCUMENT FILE**

Darrel Hawthorne

Custer

Ground Water Supply

Well No. 2

NW 1/4 NW 1/4 Sec. 17-6 S-1E

Custer County

Map No. 409-2

No. 380-2

Division No. 2

Fall River District

PERMIT

to appropriate water from

Ground Water Supply

Custer County, South Dakota

Name of applicant

Darrel Hawthorne

Name of diversion works Gordon

Cliff Irrigation Project s.d. No. 2

Date of first receipt at office of State

Engineer June 29 1951

Returned to applicant for correction

19.....

Corrected application received

19.....

Date of water right

June 29 1951

Recorded in Book 3 *Section 4* Page 4

One-fifth of work to be completed

Sept. 12 1952

Whole work to be completed

Sept. 12 1953

Final proof of use of water

Sept. 12 1953

Approved Sept. 12 1951

DEAR ... LOUCKS State Engineer.

NO. 380-2

Water Division No. 2 Fall River
(Blanks to be filled by the State Engineer.)

RECEIVED
District Office P.M.
JUN 20 1955

APPLICATION FOR PERMIT
To Appropriate Water within the State of South Dakota
OFFICE OF STATE ENGINEER
Dakota, S. DAK.

(NOTE)-Draw a line through items not applicable.

12-27-76

1. Name of applicant Harry C. Hallenbeck
State Court, Edgemont 57725
Postoffice address Edgemont, County Edgemont, State S. Dak.

- I. If a corporation None
- (a) Name of same
 - (b) Date and place of incorporation
 - (c) Amount of capital stock:
 - (d) Amount paid in
 - (e) Names and address of directors:

(NOTE)-A certified copy of articles of incorporation must accompany the application.

II. Method of accomplishing the work and financial resources of the applicant:

- (a) Method of accomplishing work (Whether by contract, employment of others, or by direct labor) Direct labor
- (b) Cash on hand, \$ 5000.00 (c) Treasury stock, \$ None
- (d) Bonds to be issued, \$ None (e) Other resources, \$

2. Name of well Golden Cliff Irrigation Project Well No. 2
3. Quantity of water claimed 300 gal. per min.
4. Source of water supply (estimated depth) 275
5. Location of well (subdivision) Sec. 17, T. 6, S. 1, E. 1
6. Annual periods during which water is to be used April 1 to Oct. 1
7. To be used for:

- I. Irrigation or domestic use: Gravity, overhead sprinkling or combination system?
- (a) Number of acres to be irrigated 126.49 acres.
 - (b) Legal subdivisions to be irrigated See List Attached
 - (c) Statement as to domestic use (giving location, etc.) None

(NOTE)-A list of lands to be irrigated, giving such subdivision and fraction, with acreage thereof, should be written here, or may be appended as a part of this application. Same must also be shown on accompanying map.

II. Stockwatering, mining, milling, power, fish culture, fire protection and public recreation:

- (a) Nature of use None
- (b) Amount of power to be generated None horse power.
- (c) Location of plant
- (d) Method of developing power
- (e) Point where return water will be diverted to stream



8. Estimated cost of works:

- (a) Head gates, \$.....
- (b) Pumping plant, \$ 2000.00
- (c) Flaming, \$.....
- (d) Canal-earth, \$.....
- Rock, \$.....
- (e) Other structures 21 ps. 5000.00 \$ 8000.00 Total, \$ 12000.00

9. Description of works:

(a) Head gate: Width feet; height feet; Material

(b) Log of well:

(To be completed when well is drilled)

FEET TO: FROM	LOG OF WELL
0 - 40	Shale and Top Soil
40 - 50	Dakota Sand
50 - 90	Fuson Formation
90 - 370	Lakota Sand
370 - 37	Morrison Formation

(c) Measuring device Pressure Gauge and Nozzle Size

(d) Canal: Total length None miles.

LOCATION BELOW HEADGATE	DEPTH	BOTTOM WIDTH	WIDTH AT WATER LINE	GRADE PER MILE
At Mile feet feet feet feet
At Mile feet feet feet feet
At Mile feet feet feet feet
At Mile feet feet feet feet
At Mile feet feet feet feet
At Mile feet feet feet feet

(Give dimension where reductions in size are made.)

(e) Was water tested for irrigation purpose?

Result: Excellent

10. Time required for completion of work 2 years.

11. Time required for complete application of water to the proposed beneficial use 1 1/2 years.

12. Choice of newspaper for publication of notice of intention to appropriate Custer Chronicle, Custer, S. Dak.

STATE OF SOUTH DAKOTA

County of Custer, S.D.

I, Dora Hanthorne, being first duly sworn on my oath depose and say: That my relation to the above described, undertaking is that of owner, that I have read the above and foregoing statement, and examined the map accompanying the same, and that I know of my own personal knowledge that the matters herein stated and shown, are true.

Signed Daniel Shaw Thorne

Subscribed and sworn to before me this 22 day of June, 19 31

Edna F. Richardson Notary Public (or other qualified officer.)



Hydrofracturing by State Engineer:

.....
.....
.....
.....

STATE OF SOUTH DAKOTA

County of Hughes } ss.
Pierre, South Dakota, Sept. 12, 1951, 19.....

This is to certify that the foregoing application was received at this office at 4:00 o'clock
P. m. upon the 22nd day of JUNE, 1951 and that after examination it
was found to comply with the South Dakota water laws, was published in accordance with the provisions
thereof and consideration given to any and all information presented found to comply with the South
Dakota water laws, was published in accordance with the provisions thereof and con-
sideration given to any and all information presented.

NO PROTESTS WERE RECEIVED.

Robert Loucks
DEAN W. LOUCKS State Engineer.

Number of permit 380-2
Date of first receipt of application June 29, 1951
Date of return to applicant for correction 19.....
Date of receipt of corrected application 19.....
Date from which applicant may claim right June 29, 1951
Approved Sept. 12, 1951, Recorded in Book 3 Page h

This is to certify that I have examined the foregoing application for a permit to appropriate
water of the State of South Dakota, and I hereby grant the same as stated herein, subject, however,
to the following limitations and conditions:

- 1st. The equivalent of at least one-fifth, of the work above specified is to be completed on or
before Sept. 12, 1952.
- 2nd. The whole of said work is to be completed on or before Sept. 12, 1953.
- 3rd. The limit of time for proof of beneficial use of water appropriated in accordance herewith
is Sept. 12, 1953.
- 4th. The water appropriated shall be used for the purpose of Providing Irrigation.
- 5th. The prior right of all persons who, by compliance with the laws of the State of South Da-
kota, have acquired a right to the use of water must not be injuriously affected by this appropriation.
- 6th. The amount of the appropriation herein granted shall not exceed 300
gallons per minute; neither shall it exceed the capacity of the above described system
of diversion works, nor the least amount of water that experience may hereafter indicate as neces-
sary for the production of crops in the exercise of the best husbandry; and further, said appropria-
tion must be limited to not more than one-seventieth (1/70) of one cubic foot of water per second of
time for each acre of land to which water is actually and beneficially applied for irrigation on or
before Sept. 12, 1953; said water to be used during the following described an-
nual period:
April 1 to October 1, Inclusive

Witness my hand this 12th day of Sept., 1951.

Robert Loucks
DEAN W. LOUCKS State Engineer.
Certificate of Construction issued SEPTEMBER 9, 1951
Water License issued SEPTEMBER 9, 1951



Location of Lands to be Irrigated by the Golden Cliff Irrigation Well No. 2.

Location	Sec.	Twp.	Rge.	Acres
N 1/4 M 1/4	17	6 S.,	1 E.,	34.40
N 1/4 M 1/4	17	6 S.,	1 E.,	5.07
N 1/4 M 1/4	17	6 S.,	1 E.,	35.25
N 1/4 M 1/4	17	6 S.,	1 E.,	38.30
N 1/4 M 1/4	18	6 S.,	1 E.,	10.46
Total,				126.48

DISCHARGE OF ONE SPRINKLER HEAD - TWO NOZZLES - 7/32 & 1/4 "

Pressure in Pounds	Discharge in GPM.
25	14.8
30	16.2
35	17.6
40	18.9
45	20.1
50	21.2
55	22.4
60	23.4

STATE OF SOUTH DAKOTA

WATER LICENSE NO. 380-2

(1) WHEREAS, On the 29th day of June, A. D. 19 51
Darrel Hawthorne

made Water Right Application No. 380-2 for a permit to use 1.78 cubic feet per second of the waters
of artesian ground water

County of Custer, State of South Dakota, for irrigation
purpose; and

(2) WHEREAS, On the 12th day of September, A. D. 19 51
Permit No. 380-2, with a date of priority of June 29, 1951

was issued to said applicant for the diversion of said water, and provided for the completion of construction of the water
supply system therein described on or before the 12th day of September, A. D. 19 53 and for the
application to beneficial use of said water on or before the 12th day of September, A. D. 19 53

and, whereas, on the 25th day of November, 1975, the Permit was
transferred to Henry C. Hollenbeck

and:

(3) WHEREAS, It is hereby certified that the applicant has complied with the provisions of the laws of the State of South Dakota
relating to completion of the construction of the water supply system and is entitled to divert .85 cubic feet
per second of water for beneficial use and,

(4) WHEREAS, It is hereby certified that the applicant has complied with the provisions of the laws of the State of South Dakota
relating to the application of water to beneficial use of the following extent.

For irrigating 60 acres in the E1/4 NW1/4, Section 17, T6S, R1E



Hydro ID 710

(5) NOW, THEREFORE, By the virtue of the authority vested in us by the laws of the State of South Dakota, We hereby grant and confirm to

Henry C. Hellenbeck

of

Edgemont

the holder and owner of said permit No. **380-2** a water right, dating from **June 29, 1951**

to use of **.85** cubic feet per second of the waters

of **artesian ground water**

in the County of **Custer** and State of South Dakota, or so much thereof as may be necessary for the

purposes hereinbelow mentioned, to be diverted at **a point in the center of NW¹, Section 17, T6S, R1E**

and conduct to and upon **60 acres in the E¹ NW¹, Section 17, T6S, R1E**

for the purpose of **Irrigation**

Subject to any limitations listed in Water Right Permit No. **380-2** and subject to the laws of the State of South Dakota.

WITNESS, My hand and seal of our office at Pierre, South Dakota

this **9th** day of **September** A. D.

Nineteen Hundred and **Seventy-seven**

WATER RIGHTS COMMISSION

By: **John Hatch**
Chief Engineer, Executive Officer

JOHN HATCH



Form 15.

Permit No. 300-2

Water Diversion No. 2 Fall River Water District

CERTIFICATE OF CONSTRUCTION

This is to Certify, That Henry C. Hollenbeck

the holder of

Permit No. 300-2, issued upon Application No. 300-2, bearing date of priority of June 29,

1931 authorizing the diversion of 1.78 cu. ft. per second of the waters of

artesian ground water county of Custer, State of South Dakota at

a point in the center of the NW 1/4 Section 17, T6S, R1E

for irrigation

purposes, he has complied with the provisions of the laws of the State of South Dakota relating to proof of completion of the works of diversion set out and described in said Permit; that said works are found in satisfactory condition for diverting and conveying to the place of intended use 1.78 cu. ft. per second of water.

Date September 9, 1977

By: **WATER RIGHTS COMMISSION**
John Hatch
JOHN HATCH, Chief Engineer



9--Notice of Intenti to appropriate Water

Nos. 379-2 & 380-2

(First Publication _____, 19__)

APPROPRIATION OF WATER

Office of State Engineer,

Pierre, S. Dak., July 10, 1951

Notice is hereby given that Darrel Hawthorne whose postoffice address is Dewey, South Dakota, has made applications in accordance with the provisions of the water laws of South Dakota for permits to appropriate for beneficial use as follows:

1000 gallons of water per minute of time from ground water supply through the Golden Cliff Irrigation Project, Well No. 1, the point of diversion of which is to be located in the NW $\frac{1}{4}$ of the SW $\frac{1}{4}$ of section 6, Twp. 65., Range 1E. 800 gallons of water per minute of time from ground water supply through the Golden Cliff Irrigation Project, Well No. 2, the point of diversion of which is to be located in the NW $\frac{1}{4}$ of the NW $\frac{1}{4}$ of Section 17, Twp. 65., Range 1E. Said water to be used for the purpose of providing irrigation on the following described land: NW $\frac{1}{4}$ Sec. 17, NE $\frac{1}{2}$ NE $\frac{1}{4}$ Sec. 18, NW $\frac{1}{4}$ Sec. 6, W $\frac{1}{2}$ NE $\frac{1}{4}$ Sec. 6, NW $\frac{1}{4}$ SW $\frac{1}{4}$ Sec 6, E $\frac{1}{2}$ SW $\frac{1}{4}$ Sec. 6, W $\frac{1}{2}$ SE $\frac{1}{4}$ Sec. 6, NE $\frac{1}{4}$ NW $\frac{1}{4}$ Sec. 6, and NW $\frac{1}{4}$ NE $\frac{1}{4}$ Sec. 7. T. 65., R. 1E.

This application will be taken up by the State Engineer at his office at Pierre for consideration upon the 21st day of August 1951, at 10:00 A.M. All persons who believe that their prior rights would be injuriously affected, or that the allowance of the permit would be detrimental to the public welfare shall file such protest with the State Engineer in writing prior to the above date and may appear on the day above mentioned in person for the purpose of discussing further, the information presented.

Appropriate action will be taken by the State Engineer after suitable time has elapsed for the consideration of any or all information presented.

NCS:mt
Inc.
cc: Richardson

DEAN W. LOUCKS
State Engineer



Permit No. 380-2

Water Division 2 Fall River Water District

**REPORT OF EXAMINATION OF WORKS
AND/OR APPLICATION OF WATER TO BENEFICIAL USE**

TO: Water Resources Commission, State Office Building No. 2, Pierre, South Dakota 57501

I have this day made a thorough examination of the water use system constructed by Darrel Hawthorne of Custer, SD holder

of Permit No. 380-2, bearing date of priority of June 29, 1951,
authorizing the diversion of 1.78 cu. ft. per second of the waters of ground water
for irrigation purposes, in Custer County.

I have to report on the condition of the same as follows:

The Water Use System consists of,

A. Works used to divert the water:

376 foot flowing artesian well, steel cased; fill's storage dam, 15 foot high, 30 foot wide at the base and 50 foot in length on the west side and 60 foot in length on the south side.

B. Works used to transport water to place of use,

Approx. 800 feet of natural ditch

C. Works used to apply water to beneficial use.

Flood irrigates by spreading

The system is in the following condition: Fair

The point of diversion is located Center of NW¹, Sec. 17, T6S., R1E., B.H.M.

The works are capable of diverting and conveying to the place of use ≈ 1.78

cu. ft. per second of water which is to be used for irrigation

Water has been put to beneficial use to the maximum extent as follows:

E¹/₂ of NW¹ of Sec. 17, T6S., R1E., B.H.M.

comprising a total of 60 acres of land.

Henry C. Hollenbeck
Star Rt.
Edgemont, SD 57735

Date 8-25-75

Thomas A. Gardner
(Signature)

THOMAS A GARDNER
Water Resources Engineer



Form 20.

No. 380-2

NOTICE OF TRANSFER OF WATER PERMIT

TO: **WATER RIGHTS COMMISSION**
State Office Building No. 2
Pierre, South Dakota 57501

Date _____

This is to notify you that title to the lands described as follows:
E 1/2 NW 1/4 of Sec. 17, T6S., R1E., B.H.M.

formerly owned by Darrel Hawthorne

has been transferred to Henry C. Hollenbeck

together with any rights to the beneficial use of water thereon as evidenced by Water Right Permit No. 380-2 as provided for in Section 61.0127 of the 1960 Supplement to the South Dakota Code of 1939.

You are therefore hereby requested to file this "Notice of Transfer of Water Permit" in its appropriate file at the Office of Water Resources Commission, evidence of the change of ownership.

A fee of one dollar is hereto attached to cover filing fees as required under Section 61.0159 of the 1960 Supplement to the South Dakota Code of 1939.

STATE OF SOUTH DAKOTA }
County of _____ } ss.

I, Henry C. Hollenbeck being first duly sworn on my oath depose and say: That my relation to the above described undertaking is that of Owner, that I have read the above foregoing statement, and I know of my own personal knowledge that the information herein stated is true.

Henry C. Hollenbeck
(Signed)

Subscribed and sworn to before me this 24th day of Nov, 19 75

Waldemar B. Beard
(Notary Public)

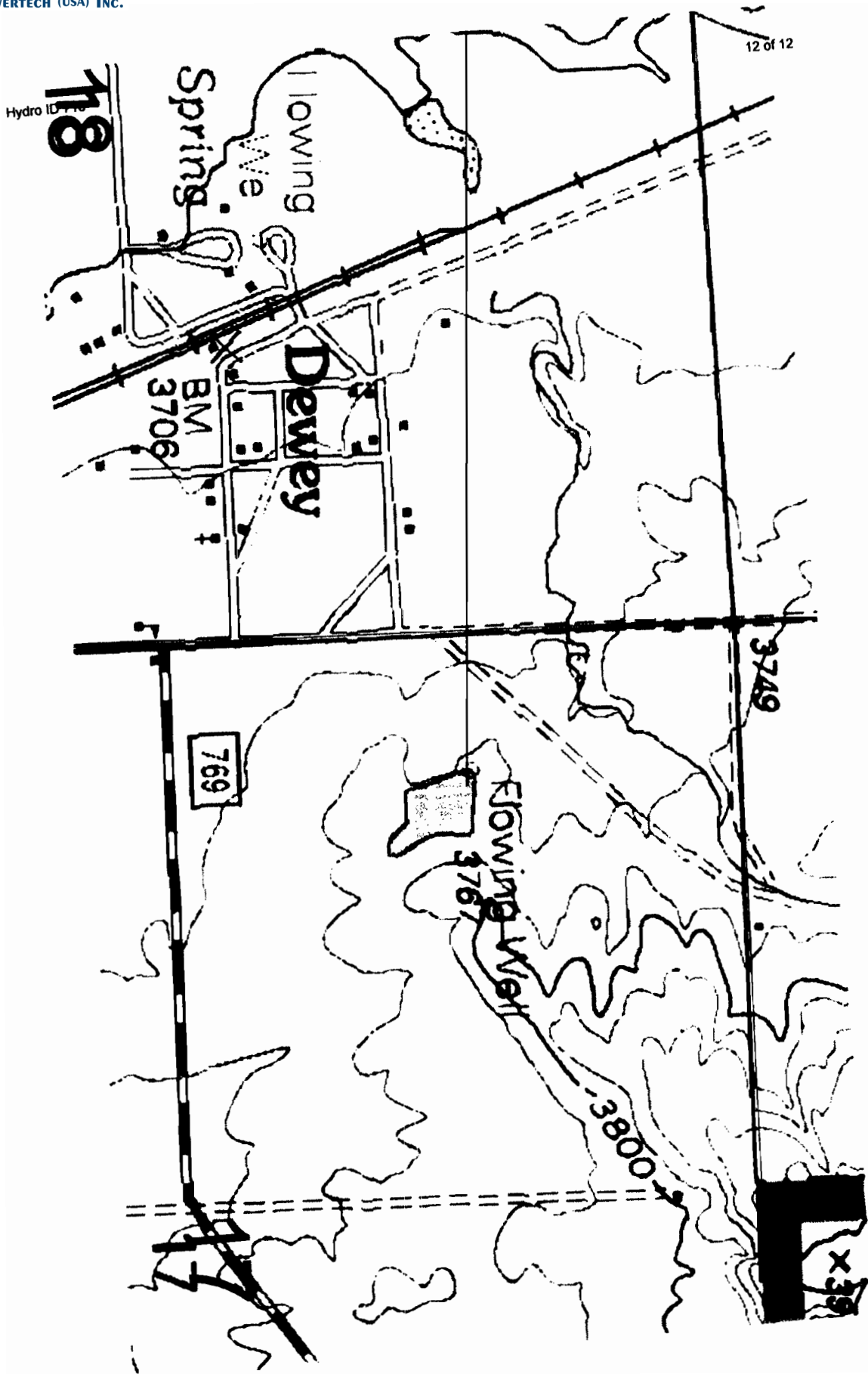



SOUTH DAKOTA WATER WELL COMPLETION REPORT

4-21-08

Location NW 1/4 56 1/4 Sec 1 Twp 75 Rg 1E
County Fall River North

Please mark well location with an "X"

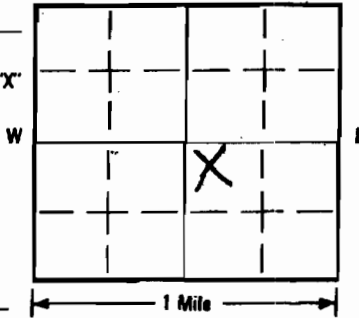

Well Completion Date

3-26-08

Well Owner: Power Tech
Business Name: Power Tech USA Inc
Address: P.O. Box 723
Hot Springs S.D 57747

FORMATION	DEPTH	
	FROM	TO
Full River	0	55
Fusow	55	80
Lakota	80	166

LOCATION:
Distance from nearest potential pollution source (septic tank, abandoned well, lead lot, etc.)? ft. from NONE Present (identify source).

PROPOSED USE:
 Domestic/Stock Municipal Business Test Holes
 Irrigation Industrial Institutional Monitoring well

METHOD OF DRILLING:
MUD + Rotary

CASING DATA: Steel Plastic Other
If other describe _____
PIPEWEIGHT DIAMETER FROM TO HOLE DIAMETER
SDR21 LB/FT 6 IN 0 FT 166 FT 8 3/4 IN

STATIC WATER LEVEL 138 Feet
If flowing: closed in pressure _____ PSI
GPM flow _____ through _____ inch pipe
Controlled by Valve Reducers Other _____
Reduced Flowrate _____ GPM
Can well be completely shut in? YES

GROUTING DATA
Grout Type No. of Sacks Grout Weight From To
CMT 34 152 lb./gal 0 ft. 166 ft.

WELL TEST DATA:
 Pumped Describe: Air lift AT 150'
 Bailed
 Other
Pumping Level Below Land Surface
_____ ft. After _____ Hrs. pumped
_____ ft. After _____ Hrs. pumped
If pump installed, pump rate _____ GPM

RECEIVED
APR 28 2008
WATER RIGHTS PROGRAM

SCREEN: Perforated pipe Manufactured
Diameter 3 IN Length 30 FEET
Material PVC
Slot Size 2020 Set From 166 Feet to 196 Feet
Other information Set K Packer

REMARKS
Dewey Burdock
8-1-6

WAS A PACKER OR SEAL USED? YES NO
If so, what material? 6" x 3" K Packer
Describe packer(s) and location? Packer set AT 156

This well was drilled under license # 745
And this report is true and accurate.
Drilling firm David Dilling
Signature of License Representative: Stan Davis

DISINFECTION: Was well disinfected upon completion?
YES, How: _____
LABORATORY: Laboratory sent to for water quality analysis
Respic
NO, Why Not? NA

Signature of Well Owner or Equitable Property Holder:
Date: 4/22/08



STATE OF WYOMING

OFFICE OF THE STATE ENGINEER
 HERSCHLER BLDG., 4-E CHEYENNE, WYOMING 82002
 (307) 777-6183

5035081
 50.00
 6/11/07

APPLICATION FOR PERMIT TO APPROPRIATE GROUND WATER

APPLICATION FOR WELLS AND SPRINGS

Note: Only springs flowing 25 gallons per minute or less, where the proposed use is domestic and/or stock watering, will be considered as ground water appropriations.

FOR OFFICE USE ONLY

Temporary Filing No. U.W. 463-211

PERMIT NO. U.W. 183561
 WATER DIVISION NO. 2 DISTRICT 1
 U.W. DISTRICT Newcastle

NOTE: Do not fold this form. Use typewriter or print neatly with black ink.
 ALL ITEMS MUST BE COMPLETED BEFORE APPLICATION IS ACCEPTABLE

NAME AND NUMBER OF WELL or SPRING Putnam 21

1. Name of applicant(s) Putnam & Putnam, LLP Phone: (605)662-7448

2. Address of applicant(s) 778 Cedar St. Dewey SD 57735
 (MAILING ADDRESS) (CITY) (STATE) (ZIP)

3. Name & address of agent to receive correspondence and notices John A. Putnam
778 Cedar St. Dewey SD 57735 Phone: (605)662-7448
 (MAILING ADDRESS) (CITY) (STATE) (ZIP)

4. Use to which the water will be applied:

- Domestic: Use of water in 3 single family dwellings or less, noncommercial watering of lawns and gardens totaling one acre or less. Number of houses served? _____
- Stock Watering: Normal livestock use at four tanks or less within one mile of well or spring. Stockwatering pipelines and commercial feedlots are a miscellaneous use. Number of stock tanks? 1 *per call 7/10/07*
- Irrigation: Watering of commercially grown crops (large-scale lawn watering of golf courses, cemeteries, recreation areas, etc., is miscellaneous use).
- Municipal: Use of water in incorporated Towns and Cities. Note 1: use of water in unincorporated towns, subdivisions, improvement districts, mobile home parks, etc. is classified as miscellaneous use. Note 2: a permit may be required by the Wyoming Department of Environmental Quality (WDEQ) if the well will be classified as a public water supply under the WDEQ's rules and regulations.
- Industrial: Long term use of water for the manufacture of a product or production of oil/gas or other minerals (oil field water flood operations, power plant water supply, etc.). (Describe in REMARKS)
- Miscellaneous: *Per call 7/10/07*
 Any use of water not defined under previous definitions such as stock water pipelines, subdivisions, mine dewatering, mineral/oil exploration drilling, potable supplies in office, etc. Describe in Remarks. Note: a permit may be required by the WDEQ if the well will be classified as a public water supply under the WDEQ's rules and regulations.
- Coalbed Methane: Water produced in the production of coal bed methane gas. Note: wells used in the production coal bed methane will require a permit from the Wyoming Oil and Gas Conservation Commission.
- Monitor, Observation: Note: a WDEQ permit may be required Test Well: (Describe in REMARKS)

5. Location of the well or spring: (NOTE: Quarter-quarter (40 acre subdivision) MUST be shown. EXAMPLE: SE 1/4 NW 1/4 of Sec. 12, Township 14 North, Range 68 West.)
Niobrara County, SW 1/4 SW 1/4 1/4 of Sec. 28, T. 41 N., R. 60 W. of the 6th P.M. (W.R.M.), Wyoming. If located in a platted subdivision, also provide Lot/Tract Block of the Subdivision (or Adm'n) of _____ Resurvey Location: Tract _____ (or Lot) _____

6. Estimated depth of the well or spring is 600 feet. Estimated production interval is Unknown to _____ ft.

7. (a) MAXIMUM instantaneous flow of water to be developed and beneficially used: 10 gallons per minute. NOTE: If for domestic and/or stock use, this application will be processed for a maximum of 25 gallons per minute. For a spring, after approval of this application, some type of artificial diversion or improvement must be constructed to qualify for a water right.

(b) MAXIMUM volumetric quantity of water to be developed and beneficially used per calendar year: 5 *per call 7/10/07*
 Circle appropriate units: (Gallons) (Acre Feet) A four person family utilizes approximately one (1) acre-foot of water per year or 325,000 gallons.

8. Mark the point(s) or area(s) of use in the tabulation box below.

TABULATION BOX																TOTAL			
TWP	RNG	SEC	NE 1/4				NW 1/4				SW 1/4				SE 1/4				
			NE 1/4	NW 1/4	SW 1/4	SE 1/4	NE 1/4	NW 1/4	SW 1/4	SE 1/4	NE 1/4	NW 1/4	SW 1/4	SE 1/4	NE 1/4	NW 1/4	SW 1/4	SE 1/4	
41	60	28												X					1 Stock Tank

Permit No. U.W. 183561 SEE REVERSE SIDE Book No. 1329 Page No. 61



- a. Describe MAXIMUM acreage to be irrigated in each 40 acre subdivision in the tabulation box above.
- b. Land will be irrigated from this well only.
- c. Land is irrigated from existing water right(s) with water from this well to be additional supply. Describe existing water right(s) under REMARKS.

10. If for irrigation use, describe method of irrigation, i.e. center pivot sprinkler, flood, etc.:

11. The well or spring is to be constructed on lands owned by Putnam & Putnam, LLP
(The granting of a permit does not constitute the granting of right-of-way. If any easement or right-of-way is necessary in connection with this application, it should be understood that the responsibility is the applicant's. A copy of the agreement should accompany this application, if the land is privately owned and the owner is not the co-applicant.)

12. The water is to be used on lands owned by Putnam & Putnam, LLP
(If the landowner is not the applicant, a copy of the agreement relating to the usage of appropriated water on the land should be submitted to this office. If the landowner is included as co-applicant on the application, this procedure need not be followed.) NOTE: Water rights attach to the area(s) and/or point(s) of use.

REMARKS: Existing well is not currently water producing. Well was dug 1936

Under penalties of perjury, I declare that I have examined this application and to the best of my knowledge and belief it is true, correct and complete.
Signature of Applicant or Authorized Agent: [Signature] Date: 20 07

THE LEGALLY REQUIRED FILING FEE MUST ACCOMPANY THIS APPLICATION

DOMESTIC AND/OR STOCK WATERING USES <small>(Domestic use is defined as use of water in 3 single family dwellings or less, noncommercial watering of lawns and gardens totalling one acre or less.)</small>	\$25.00
IRRIGATION, MUNICIPAL, INDUSTRIAL, MISCELLANEOUS, COAL BED METHANE	\$50.00
MONITOR (For water level measurements or chemical quality sampling) or TEST WELL	No Fee

IF WELL WILL SERVE MULTIPLE USES, SUBMIT ONLY ONE (THE HIGHER) FILING FEE.

THIS SECTION IS NOT TO BE FILLED IN BY APPLICANT

THE STATE OF WYOMING)
) ss
STATE ENGINEER'S OFFICE)
This instrument was received and filed for record on the 12th day of June, A.D. 20 07, at 9:18 o'clock A.M.

Permit No. U.W. 133501 [Signature] for State Engineer

THIS IS TO CERTIFY that I have examined the foregoing application and do hereby grant the same subject to the following limitations and conditions:

This application is approved subject to the condition that the proposed use shall not interfere with any existing rights to ground water from the same source of supply and is subject to regulation and correlation with surface water rights, if the ground and surface waters are interconnected. The use of water hereunder is subject to the further provisions of Chapter 169, Session Laws of Wyoming, 1957, and any subsequent amendments thereto.

Granting of a permit does not guarantee the right to have the water level or artesian pressure in the well maintained at any specific level. The well should be constructed to a depth adequate to allow for the maximum development and beneficial use of ground water in the source of supply.

If the well is a flowing artesian well, it shall be so constructed and equipped that the flow may be shut off when not in use without loss of water into sub-surface formations or at the land surface.

Coal Bed Methane wells have Additional Conditions and Limitations on attachment sheet. This permit and accompanying notices serve to register an existing well and establish a valid water right for the same. Time limit for Completion of Construction and Completion of Beneficial Use is waived.

Approval of this application may be considered as authorization to proceed with construction of the proposed well or spring. A Statement of Completion will be filed within thirty (30) days of completion of construction, including pump installation.

Completion of construction and completion of the beneficial use of water for the purposes specified in Item 4 of this application will be made by December 31, 20 07.

The amount of appropriation shall be limited to the quantity to which permittee is entitled as determined at time of proof of application of water to beneficial use.

Witness my hand this 29th day of October, A.D. 20 07.

[Signature] for PATRICK T. TYRRELL, State Engineer

October 16, 2007 - Statement of Completion on 1936 received. Beneficial Use assumed as of date of completion.

FORM U.W.8
Rev. 1/07

STATE OF WYOMING
OFFICE OF THE STATE ENGINEER
HERSCHLER BLDG., 4-E
CHEYENNE, WYOMING 82002
(307) 777-6163

STATEMENT OF COMPLETION AND DESCRIPTION OF WELL OR SPRING

NOTE: Do not fold this form. Use typewriter or print neatly with black pen.

PERMIT NO. U.W. 183561 NAME OF WELL/SPRING Putnam 21

1. NAME OF OWNER PUTNAM & PUTNAM, LLP

2. ADDRESS 778 CEDAR ST

City DEWEY State SD Zip Code 57735 Phone No. 605-662-7448

3. USE OF WATER Domestic Stock Watering Irrigation Municipal Industrial Miscellaneous
 Monitor or Test Coal Bed Methane Explain proposed use (Example: One single family dwelling)

1 stock tank

4. LOCATION OF WELL/SPRING SW 1/4 SW 1/4 of Section 28 T. 41 N., R. 60 W., of the 6th P.M. (or W.R.M.)

Subdivision Name _____ Lot _____ Block _____

Resurvey Location Tract _____ or Lot _____ Datum NAD27 NAD83

Geographic Coordinates: Latitude _____ N Longitude _____ W (degrees, minutes, seconds)

UTM: Zone 13 Northing 7816400 Easting 574367 (meters) per rec'd

State Plane Coordinates: Zone _____ Northing _____ Easting _____ (feet) 1012367

Land surface elevation (ft. above mean sea level) _____ Datum NAVD29 NAVD88

Source GPS Map Survey Unknown Other Altimeter (for elevation only)

5. TYPE OF CONSTRUCTION Drilled _____ Dug Driven Other

Describe _____

6. CONSTRUCTION Total depth of well/spring 639 ft.

Depth of static water level 0 Flows ft. (below land surface) Casing height 2 ft. above ground

a. Diameter of borehole (bit size) 5 inches inches

b. Casing schedule New Used Joint type Threaded Glued Welded

_____ diameter from _____ ft. to _____ ft. Material _____ Gage _____

_____ diameter from _____ ft. to _____ ft. Material _____ Gage _____

c. Cemented/grouted interval, from _____ ft. to _____ ft.

Amount of cement/grout used _____ type _____ (example: 10 sacks) (example: bentonite pellets)

d. Type of completion Customized perforations Open hole Factory screen

Type of perforator used _____

Size of perforations _____ inches by _____ inches.

Number of perforations and depths where perforated

_____ perforations from _____ ft. to _____ ft.

_____ perforations from _____ ft. to _____ ft.

Open hole from _____ ft. to _____ ft.

Well screen details

Diameter _____ slot size _____ set from _____ ft. to _____ ft.

Diameter _____ slot size _____ set from _____ ft. to _____ ft.

e. Well development method _____ How long was well developed? _____

f. Was a filter/gravel pack installed? Yes No Size of sand/gravel _____

Filter/gravel pack installed from _____ ft. to _____ ft.

g. Was surface casing used? Yes No Was it cemented in place? Yes No

Surface casing installed from _____ ft. to _____ ft.

7. NAME AND ADDRESS OF DRILLING COMPANY UNKNOWN

8. DATE OF COMPLETION OF WELL (including pump installation) OR SPRING (first used) 1936

9. PUMP INFORMATION Manufacturer None Type _____

Source of power _____ Horsepower _____ Depth of pump setting or intake _____ ft.

Amount of water being pumped _____ gal./min.* (For springs or flowing wells, see item 10)

Total volumetric quantity used per calendar year. 5 AE/yr per U.W. 5

*If these amounts exceed permitted amount an enlargement is required.

10. FLOWING WELL OR SPRING (Owner is responsible for control of flowing well)

If artesian flow or spring, yield is 5 gal./min. *Surface pressure is _____ lb./sq.inch, or _____ feet of water.

The flow is controlled by Valve Cap Plug

Does well leak around casing? Yes No

Permit No. U.W. 183561 Book No. 1329 Page No. 61

SEE REVERSE SIDE

11. IF SPRING, HOW WAS IT CONSTRUCTED? (Some method of artificial diversion, i.e., spring box, cribbing, etc., is necessary to qualify for a water right) _____
12. PUMP TEST Was a pump test conducted? Yes No
 If so, by whom _____
 Yield _____ gal./min. with _____ ft. drawdown after _____ hours
 Yield _____ gal./min. with _____ ft. drawdown after _____ hours
13. LOG OF WELL Total depth drilled 6.35 ft.
 Depth of completed well _____ ft. Diameter of well _____ inches
 Depth to first water bearing formation _____ ft.
 Depth to principal water bearing formation Top _____ ft. to Bottom _____ ft.

DRILL CUTTINGS DESCRIPTION

From Feet	To Feet	Rock Type or Description	Formation	Water Bearing? (Yes or no)
Surface				
		Not Available		

14. DOES A GEOPHYSICAL LOG ACCOMPANY THIS FORM? Yes No
15. QUALITY OF WATER INFORMATION
 Does a chemical and/or bacteriological water quality analysis accompany this form? Yes No
 It is recommended that chemical and bacteriologic water quality analyses be performed and that the report(s) be filed with the records of this well (contact Department of Agriculture, Analytical Lab Services, Laramie, 742-2984).
 If not, do you consider the water as: Good Acceptable Poor Unusable
- REMARKS _____

Under penalties of perjury, I declare that I have examined this form and to the best of my knowledge and belief it is true, correct, and complete

John A. Burdick for Dewey-Burdock & Burdick LLP _____ 10.15.07 _____
 Signature of Owner or Authorized Agent Date

FOR STATE ENGINEER'S USE ONLY

Permit No. U.W. 188361
 Date of Receipt OCT 15 2007 Date of Approval 10-29 2007
 Date of Priority June 12 2007 Cheryl Verplancke
 for State Engineer



SOUTH DAKOTA WATER WELL COMPLETION REPORT

07-92

Location SW SW 1/4 Sec 15 Twp 65 Rg 1E
 County Custer
 Please mark well location with an "X"
 Well Completion Date Jan 98
 1 Mile

Well Owner: Don Spencer
 Business Name:
 Address: Box 59 Box 74 Edgemont SD 57735

FORMATION	DEPTH	
	FROM	TO
<u>Mowry Shale</u>	<u>0</u>	<u>80</u>
<u>Newcastle Sand</u>	<u>80</u>	<u>140</u>

LOCATION:
 Distance from nearest potential pollution source (septic tank, abandoned well, feed lot, etc.)? _____ ft. from None (identify source).

PROPOSED USE:
 Domestic/Stock Municipal Business Test Holes
 Irrigation Industrial Institutional Monitoring well

METHOD OF DRILLING:
Air Rotary

CASING DATA: Steel Plastic Other
 If other describe _____
 PIPEWEIGHT DIAMETER FROM TO HOLE DIAMETER
200 LB/FT 5 IN 0 FT 140 FT 7 7/8 IN
 _____ LB/FT _____ IN _____ FT _____ FT _____ IN
 _____ LB/FT _____ IN _____ FT _____ FT _____ IN

STATIC WATER LEVEL 90 Feet
 If flowing: closed in pressure _____ PSI
 GPM flow _____ through _____ inch pipe
 Controlled by Valve Reducers Other _____
 Reduced Flowrate _____ GPM
 Can well be completely shut in?

GROUTING DATA
 Grout Type Cement No. of Sacks 11 Grout Weight 694 lb./gal From 0 ft. To 80 ft.
 _____ lb./gal _____ ft. _____ ft.
 Describe grouting procedure Pumped

WELL TEST DATA:
 Pumped Describe: Air lift 15-20 gpm
 Bailed
 Other
 Pumping Level Below Land Surface
 _____ ft. After _____ Hrs. pumped _____ GPM
 _____ ft. After _____ Hrs. pumped _____ GPM
 If pump installed, pump rate _____ GPM

SCREEN: Perforated pipe Manufactured
 Diameter 5 IN Length 60 FEET
 Material pvc
 Slot Size 2.5 Set From 80 Feet to 140 Feet
 Other information _____

REMARKS

WAS A PACKER OR SEAL USED? YES NO
 If so, what material? Rubber packer @ 80ft
 Describe packer(s) and location?

This well was drilled under license # 1003
 And this report is true and accurate.
 Drilling firm Jeff Miller Drilling
 Signature of License Representative Jeff Miller
 Signature of Well Owner or Eligible Property Holder: Don Spencer
 Date: January 20, 1999

DISINFECTION: Was well disinfected upon completion?
 YES, How: Chlorine Tablets
 NO, Why Not?
 Laboratory sent to for water quality analysis



WATER PERMIT NO. 1954-2

MAP No. SAME

Name of Applicant Burlington Northern RR

Post Office Address Box 597 Alliance, Neb.

Amount of Water Claimed 0.17 cfs Total Acres N.A.

Source of Water Supply Ground water (one well ≈ 250 ft)

Water to be used for sanitary purposes in maintenance building County Custer

About 23 miles SW of Custer

PROOF OF PUBLICATION: Received April 14, 1986 Not Received _____

APPLICATION: Approved May 14, 1986 Subject to _____

F.F.& C.L. Adopted _____ Not Approved _____ Deferred _____

PRIORITY : Date Received 1-27-86 Fee \$150.00 Remarks _____

Corrected Application Received _____ Period of Annual Use Jan to Dec-31

WATER QUALITY APPROVAL RECEIVED N.A. APPROVED/CONDITIONAL (Circle one)

WI-1 Description same as Application YES NO REMARKS _____

Diversion Point SW 1/4 NE 1 section 18 T6S-R1E

Land to be Irrigated N.A.

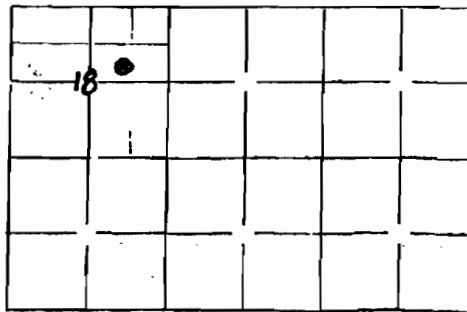

Well Log: Driller Ruby Daly Licensed YES NO

Depth of Well ≈ 250 ft. REMARKS _____

Type of Map Plat. PREPARED BY Burlington Northern Reviewed and the Number

assigned on Feb. 4, 1986 By K.C. Larson



NO MATCH SWNE 18-6S-1E BNRR
FORM 2: Application for uses other than irrigation (type or print)

2 of 23
Mail to: Water Rights Div.
DWNR, Foss Bldg.
Pierre, SD 57501
(605) 773-3352

No. 1984-2 Hydrologic Unit 10120107
Map No. Same Basin Upper Cheyenne
Newspaper Custer Co. Chronicle, Box 557, Custer (WFO)

Application For Permit To Appropriate Water Within The State Of South Dakota

Check use of water: Industrial Commercial Municipal Other Common Distribution System
Rural Water System Suburban Housing Geothermal Heat Institutional Recreational
Domestic (above 18gpm) Other

Type of Application: Check one or more of the following

New Vested Right Future Use Change Use
 Amend Permit No. _____ with old priority date retained
Change diversion point(s) Add diversion point(s) Other _____
 Application to: Change diversion point(s) Add diversion point(s) on Permit No. _____
 Construction to use water reserved by Future Use Permit No. _____

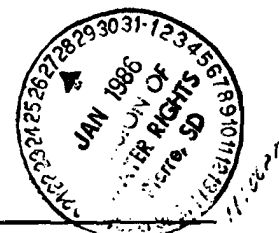

1. Name of Applicant Burlington Northern R.R. Co. Phone No. (308) 762-6000 Ext: 2238
Post Office Address Box 597, Alliance, State Ne 69301
(Street, R.R. or Box) Zip Code

2. Amount of water claimed (c.f.s) 75 gpm (0.17 cfs)

3. Source of water supply Ground water

4. Location of point of diversion SW 1/4 NE 1/4 section 18 T6S-R1E

County Custer

5. Counties where water will be used Custer

6. Annual period during which water is to be used January 1 until December 31

7. Give a brief description of proposed project. When available include any preliminary engineering report or other reports or information that will help explain the project. (Attach sheet if more space is needed)
Installing 12' X 48' modular Bldg. at Dewey, S.D. as headquarters for track gangs and signal maintainer. Will include 1-lavatory , 1-water closet with tank and 1-Electric water cooler. Water use will be very minimal

Attachments: Attach Form 2A if diversion from a well or dugout, or if storage of water, is proposed. Attach map (see instruction)

STATE OF SOUTH DAKOTA)
County of _____)

I, Burlington Northern Railroad Co. the applicant, certify that I have read the foregoing application, have examined the attached map and that the matters herein stated are true and that I intend, and am able to complete the necessary construction.

Signed R. A. Wozniak

Subscribed and sworn to before me this 30th day of December 19 85

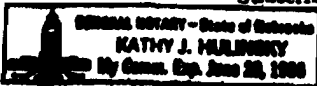

Kathy J. Hulensky
Notary Public (or other qualified officer)



WATER PERMIT

The Water Management Board hereby approves Water Permit Application No. 1954-2

Burlington Northern R.R. Co Box 597, Alliance
(Applicant) (Post Office Address)

NE 59301 With the following qualifications.
(State) (Zip Code)

The well casing shall be pressure grouted with cement (bottom to top) above the water producing formation (Fall River) and construction shall be in compliance with Water Management Board Well Construction Rules, Chapter 74:02:04.

The well approved under this Permit shall be valved and the flow reduced to the amount needed or to a minimum when not being used. The well shall also be equipped with a pressure gauge and a record kept of any pressure fluctuations. Such records shall be available to the Chief Engineer upon request. If this well is abandoned or the Permit cancelled, the well must be plugged in accordance with rules of the Water Management Board.

The well approved under this Permit will be located near domestic wells and other wells which may obtain water from the same aquifer. The well owner, under this Permit shall control his withdrawals so there is not a reduction of needed water supplies in adequate domestic wells or in adequate wells having prior water rights.

Date of first receipt of application January 27, 1986.

Date of return to applicant for correction, amendments or changes required January 28, 1986.

Date of receipt of corrected application Feb 3, 1986. Approved May 14, 1986.

The Water Management Board hereby approves this Water Permit No. 1954-2 authorizing the construction of the water use system and the placing of water to beneficial use as stated in the Application and as qualified in the Water Permit approval, subject, however, to the following limitations and conditions:

- 1. The date from which applicant may claim right is January 27, 1986.
- 2. The equivalent of at least one-fifth of the specified work is to be completed on or before October 14, 1988.
- 3. The whole of said work is to be completed on or before May 14, 1991.
- 4. The limit of time from proof of beneficial use of water appropriated in accordance herewith is May 14, 1995.
- 5. The water appropriated shall be used for the purpose of sanitary use in a maintenance building.
- 6. The prior right of all persons who, by compliance with the laws of the State of South Dakota, have acquired a right to the use of water must not be unlawfully impaired by this appropriation.
- 7. The amount of the appropriation herein granted shall not exceed .17 cubic feet per second; neither shall it exceed the capacity of the above described water supply system nor shall it exceed the amount of water needed for beneficial uses served and to which water is actually and beneficially applied for commercial use on or before May 14, 1995; said water to be used during the following described annual period: Jan 1 - Dec 31

WATER MANAGEMENT BOARD

By: John Hatch
Chief Engineer

JOHN HATCH
Division of Water Rights
Dept. of Water and Natural Resources

JUN 20 1986



Supplemental Information

(type or print in ink)

1. Well Information - Proposed construction *SEE ATTACHED PLAN SHEET*

- a) Drill Hole Diameter 8 3/4 Depth 200-250
6" HOSE THROUGH LAROTA SAND UNIT WITH 4" SCREEN
- b) Casing Type PVC Diameter 6" ID Thickness SCH 200
- c) Screen Type PVC Diameter 4" ID Thickness SCH 200
- d) Gravel Pack Thickness NO Length of Gravel Pack NO
- e) Depth to Top of Water Bearing Material TOP OF FALL RIVER 60' TOP OF LAROTA 200-250
- f) Depth of Water (ground surface to water level) WELL WILL BE ARTESIAN (EXPECT 20-60 GPM FLOW)
- g) Distance to nearest existing domestic well: 300 FT

On applicants property BN PROPERTY On property owned by others _____

2. Dugout Information Estimates

- a) Surface Dimensions _____ Depth _____
- b) Depth to water (ground surface to water level) _____

3. Water Storage Dams

If the proposed water use system contains one or more storage dams, please furnish the information requested below. The locations of each dam should be shown on the map submitted with the application.

- a) If a private engineering firm or government agency was involved in the design of this dam please give their name and address

b) Freeboard _____

c) Crest Width _____

Crest Length _____

d) Height _____

e) Outlet Dimensions:

Pipe diameter _____

Spillway width _____

f) X & Y Slope

Upstream _____

Downstream _____

Surface Area of Impoundment _____

Storage _____ acre feet

Drainage area above dam _____

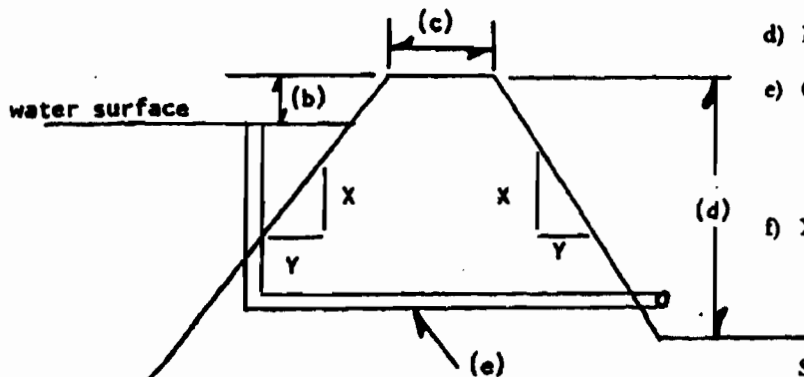

R. L. Wolven for B.N.R.R.

Signature of Applicant

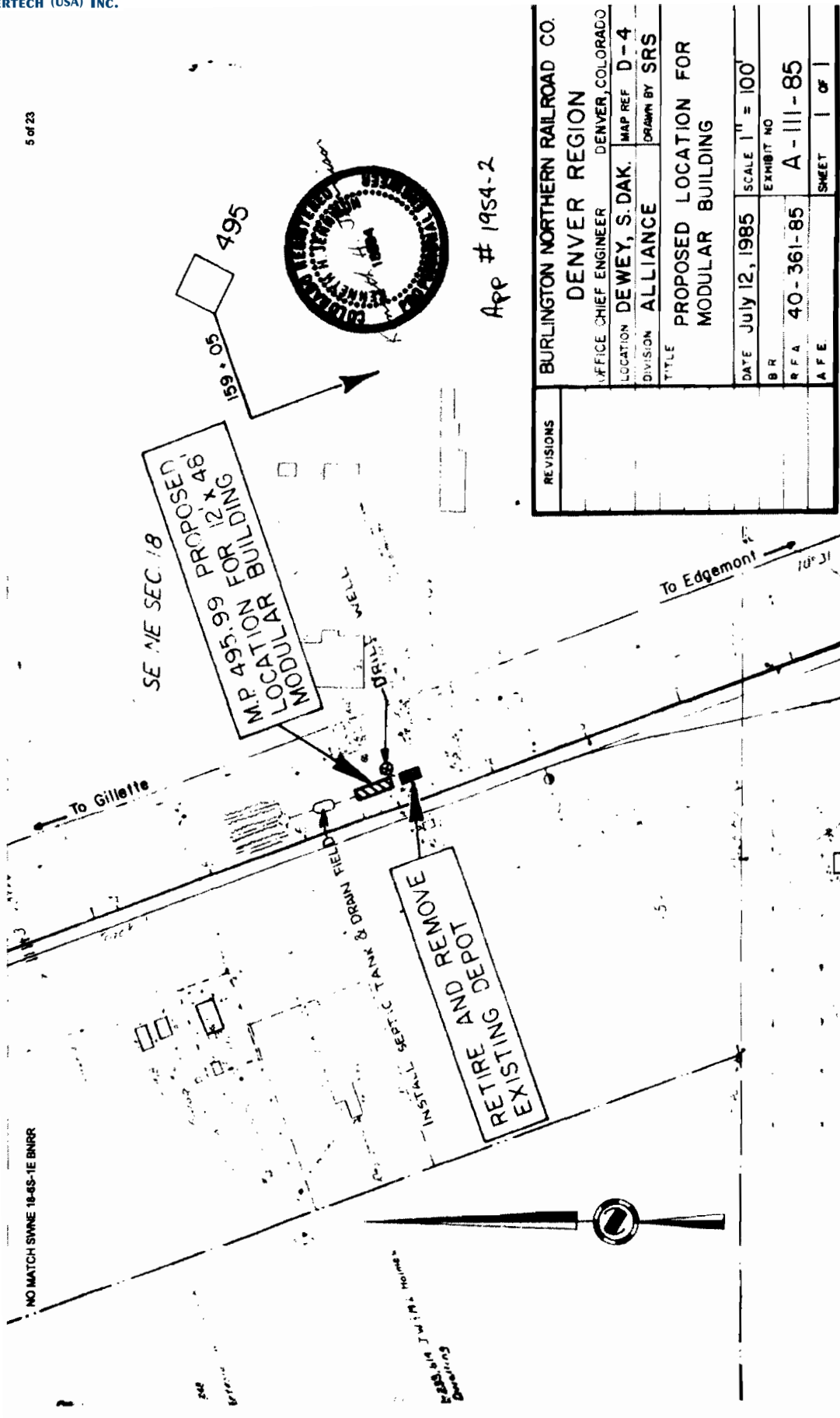



WELL CUMMINGTON SWINE 1805-1E BURDACK
OR BA WELL AT DEWEY S.D.
JESPER COUNTY
BY RABY DRILLING & EXP
FOUNTAIN, S.D. DAK.

6" TO 2" S.C.P. FLANGE 80122/ UNCL
TO CONTROL FLOW
6" SCH 200 WELL CASING (PVC)
SURFACE TO TOP OF CUMMINGTON
UNIT

SKULL CREEK

8 3/4" DRILL PIPE

FALL RIVER - FUSON

CUMMINGTON UNIT SURFACE TO
BOTTOM OF 6" WELL CASING

LAKOTA

TOP OF AQUIFER

6" DRILL HOLE THROUGH AQUIFER

4" SLOTTED W.S.U. SCREEN
P.A. 11.00

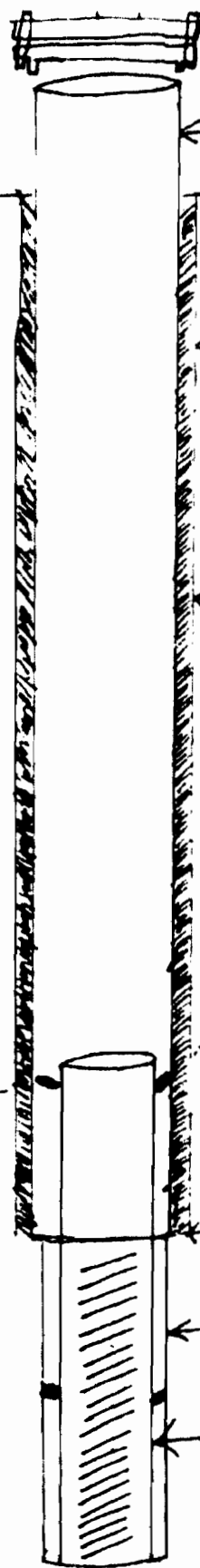

NO MATCH SWINE 18-08-1E BNRR
RECEIPT
 Division of Water Rights
 South Dakota Department of Water and Natural Resources

7 of 23

No 4 10313 -

Pierre, South Dakota 57501-1001

RECEIVED OF South Dakota Department of Water and Natural Resources

the following amount in fees for services rendered as provided for by law:

Fee for Application for Permit No. <u>1954-2</u> to Appropriate Water, to construct works and to put water to beneficial use	
Fee for Application for Permit No. <u> </u> to Appropriate Water for Future Use	
Fee to retain Future Use Permit No. <u> </u> after period of seven years	
Fee for Inspecting Constructed Works, confirming beneficial use and issuing Water License No. <u> </u>	
Fee for Filing Transfer Form	
Fee for Filing Extension Request	
Fee for Certified Copy of <u> </u>	
Fee for Print Copy of Map <u> </u>	
Fee for Certifying <u> </u>	
Fee for <u> </u> (Any Other Work Provided by Law)	
Total	

By
 Chief Engineer



NO MATCH SWNE 18-6S-1E BNRR

8 of 23

South Dakota
Department of
Water & Natural Resources

Joe Foss Building
523 East Capitol
Pierre, South Dakota 57501-3181

Water Rights Division
605 773-3352

January 28, 1986

Burlington Northern RR Co.
ATTN: R.L. Wolzen
Box 597
Alliance NE 69301

Mr. Wolzen:

I am in receipt of your water permit application in Custer County. Before we can complete processing of your application we will need:

1. The amount of water you plan on utilizing from the well.
2. A filing fee based on water use.

0-45 gpm	\$50.00
45-75 gpm	150.00
75-150 gpm	225.00

When we receive the above information we can continue to process your application. If you have any questions, please contact this office.

Thank you,

KEVIN C LARSON
Natural Resources Engineer

KCL:ks

RECOMMENDATION OF CHIEF ENGINEER FOR WATER PERMIT

APPLICATION No. 1954-2, Burlington Northern Railroad

Pursuant to SDCL 46-2A-2, the following is the recommendation of the Chief Engineer, Water Rights Division, Department of Water and Natural Resources concerning Water Permit Application No. 1954-2, Burlington Northern Railroad, Box 597, Alliance NE.

The Chief Engineer is recommending APPROVAL of Application No. 1954-2 because 1) there is reasonable probability that there is unappropriated water available for the applicant's proposed use, 2) the proposed diversion can be developed without unlawful impairment of existing rights, 3) the proposed use is a beneficial use and 4) in the public interest with the following qualifications:

1. The well casing shall be pressure grouted with cement (bottom to top) above the water producing formation (Fall River) and construction shall be in compliance with Water Management Board Well Construction Rules, Chapter 74:02:04.
2. The well approved under this Permit shall be valved and the flow reduced to the amount needed or to a minimum when not being used. The well shall also be equipped with a pressure guage and a record kept of any pressure fluctuations. Such records shall be available to the Chief Engineer upon request. If this well is abandoned or the Permit cancelled, the well must be plugged in accordance with rules of the Water Management Board.
3. The well approved under this Permit will be located near domestic wells and other wells which may obtain water from the same aquifer. The well owner, under this Permit shall control his withdrawals so there is not a reduction of needed water supplies in adequate domestic wells or in adequate wells having prior water rights.

See the attached report for additional information.

JOHN HATCH, Chief Engineer
March 10, 1986

REPORT ON APPLICATION NO. 1954-2

BURLINGTON NORTHERN RAILROAD

February 6, 1986

Application No. 1954-2 proposes to appropriate 0.17 cfs from one well approximately 250 feet deep, located in the SW $\frac{1}{4}$ NE $\frac{1}{4}$ Section 18, T6S, R1E. Water will be used for sanitary purposes in a maintenance building.

Aquifer: Fall River Sandstone - Inyan Kara Group

The Fall River Sandstone is the youngest member of the lower Cretaceous aged Inyan Kara Group. The Fall River overlies the Fuson Shale member of the Lakota Formation. The Fuson acts as a leaky aquitard between the Fall River and Lakota aquifers. However, an aquifer test conducted approximately 5 miles south of the applicant's proposed well site suggests a direct hydrologic connection between the Lakota Formation and the Fall River Sandstone. The Lakota is composed of a crossbedded channel-filled sandstone, shale, some localized limestone, and thin conglomerate lenses. The Fall River consists of well-bedded, fine-grained sandstone and less abundant interbedded siltstone and claystone. Conformably overlying the Fall River is the Skull Creek Shale, which acts as a confining bed.

The Inyan Kara underlies approximately 360,960 acres of Custer County and contains an estimated 8,121,600 acre-feet of recoverable water in storage (Allen, 1984). The average annual recharge to the Inyan Kara has not been quantified and the source has not been identified. Possible sources of recharge include: Meteoric water and downward leakage through the overlying shale; water taken in at the outcrop; and upward migration of water from the underlying Paleozoic Limestones, along solution collapses and breccia pipes associated with fractures. The Inyan Kara aquifers are under artesian conditions, and wells completed in the Fall River and Lakota flow in this area.

The Division of Water Rights does not monitor any observation wells in this area, and there are few domestic wells from which information can be obtained.

Review of Existing Permits

<u>Permit</u>	<u>Owner</u>	<u>Location</u>
0181-2	Grand Island & Wyo Cent RR. Co.	Sec 18, T6S, R1E
0182-2	Grand Island & Wyo Cent RR. Co.	Sec 18, T6S, R1E
0183-2	Grand Island & Wyo Cent RR. Co.	Sec 18, T6S, R1E
379-2	Henery C Hollenbeck	Sec 6, T6S, R1E
380-2	Darrel Hawthorne	Sec 17, T6S, R1E

Conclusions

1. Water is available for appropriation from the Inyan Kara in the area of the proposed well.
2. Because the amount of water requested is minimal, there will be no significant impacts on the water levels in the aquifer.



Application No. 1954-2

Page 2

3. The well should be constructed according to the Well Construction Standards of South Dakota, Chapter 74:02:04.
4. The three permits held by Grand Island and Wyoming Central Rail Road divert water from three springs located near the applicant's proposed well site. Review of the geologic map of the area indicates the source of the springs may be the Inyan Kara (Brobst, 1961). If the specific capacity of the well is low and the springs are located high on the potentiometric surface, interference could be a problem.

KENT BUHLER

Natural Resources Engineer

References

- Allen, J.C., Iles, D.L., Petres, A.K., 1984, Analysis of Groundwater and Streamflow Data, Western Dakotas Region of South Dakota, Tasks 3 & 4: Groundwater Resources Inventory, U.S. Army Corps of Engineers, DWNR, Division of Geologic Survey, Vermillion, SD, Contract DAWC 45-82-C-0151.
- Brobst, D.A., 1961, "Geology of the Dewey Quadrangle, Wyoming-South Dakota", Geology of Uranium Deposits in South Black Hills, Geological Survey Bulletin 1063-B.

Instruction to Newspaper - Publish first publication of the following Notice on or before March 26, 1986 with 2nd publication 1 week later. The applicant is responsible for payment.

No. 1954-2

NOTICE OF HEARING on Application No. 1954-2 to Appropriate Water and/or to Amend Water Permit or Water Right No. _____

Notice is hereby given that Burlington Northern R.R. whose mailing address is Box 597, Alliance, Nebraska, ~~South Dakota~~ has made an application for a permit

to appropriate 0.17 cubic feet per second from one well approximately 250 feet deep (Fall River Sandstone - Inyan Kara Group) located in the SW 1/4 NE 1/4 Section 18-T6S-R1E. Water will be used for sanitary purposes in a maintenance building.

Pursuant to SDCL 46-2A-2 the Chief Engineer of the Water Rights Division recommends **APPROVAL** of Application No. 1954-2 because 1) unappropriated water is available, 2) will be no unlawful impairment of existing rights, 3) is beneficial use of water and 4) is in the public interest.

This application will be considered by the Water Management Board at Room 216, Joe Foss Building, 523 E. Capitol, Pierre, South Dakota, May 14 1986 at 10:00 am.

The recommendation of the Chief Engineer is not final or binding upon the Board and the Board is authorized to 1) approve, 2) approve with qualifications, 3) defer, or 4) deny this application after it reaches a conclusion based upon facts presented at the public hearing. Any interested person who may be affected by a Board decision and who intends to participate in the hearing before the Board and present evidence or cross-examine witnesses according to SDCL May 2, 1986 must file a written petition with BOTH the applicant and the Chief Engineer by May 2, 1986. The petition may be informal, but it must include a statement describing the petitioners interest in the application, the reasons for the petitioner's opposition to or support of the application, and the signature and mailing address of the petitioner or his legal counsel if legal counsel is obtained. The applicant need not file a petition.

This application is made pursuant to the provisions of SDCL 46-1-1 thru 46-1-9, 46-1-12 thru 46-1-15; 46-2-3.1, 46-2-9, 46-2-11, 46-2-13, 46-2-17; 46-2A-1 thru 46-2A-10, 46-2A-12, 46-2A-14, 46-2A-15; 46-5-1 thru 46-5-11, 46-5-13 thru 46-5-15, 46-5-24, 46-5-25, 46-5-30.2 46-5-30.4, 46-5-31; ~~(ground)~~ 46-6-3, 46-6-3.1, 46-6-6.1, 46-6-10, 46-6-13, 46-6-14; ~~(future use)~~ ~~46-5-38 thru 46-5-40; (transfer lands) 46-5-30.4, 46-5-33 thru 46-5-35; (10,000 AFA) 46-5-30.1, 46-5-8.1; and Board Rules ARSD 74:02:01:01 thru 74:02:01:15; (future use) 74:02:01:24 thru 74:02:01:25; (10,000 AFA) 74:02:01:15:02 thru 74:02:01:15:05.~~

This hearing is an adversary proceeding. The applicant or any person, after filing a petition, has the right to be present or to be represented by a lawyer. These and other due process rights will be forfeited if they are not exercised. Decisions of the Board may be appealed to the Circuit Court and the State Supreme Court as provided by law.

Any person wishing a copy of the Chief Engineer's recommendation, further information on this application or to assure access to the hearing by the handicapped can contact the Water Rights Division, DWNR, Joe Foss Bldg, Pierre SD (605 773-3352) for assistance prior to the hearing date. The time of the hearing will be automatically extended for at least twenty days upon written request of the applicant or any person who has filed a petition to oppose or support the application. The request for extension must be filed with the Chief Engineer by May 2, 1986.



Form 10-1 Publication Notice of Hearing to Appropriate Water

Notice of Hearing

NOTICE OF HEARING on Application No. 1954-2 to Appropriate Water

Notice is hereby given that Burlington Northern R. R. whose mailing address is Box 597, Alliance, Nebraska, has made an application for a permit to appropriate 0.17 cubic feet per second from one well/ approximately 250 feet deep (Fall River Sandstone - Iowan Kara Group) located in the SW 1/4 NE 1/4 Section 18 - T6S - R1E. Water will be used for sanitary purposes in a maintenance building.

Pursuant to SDCL 46-2A-2 the Chief Engineer of the Water Rights Division recommends APPROVAL of Application No. 1954-2 because 1) unappropriated water is available, 2) will be no unlawful impairment of existing rights, 3) is beneficial use of water and 4) is in the public interest.

This application will be considered by the Water Management Board at Room 214, Joe Foss Building, 523 E. Capitol, Pierre, South Dakota, May 14, 1986 at 10:00 a.m.

The recommendation of the Chief Engineer is not final or binding upon the Board and the Board is authorized to 1) approve, 2) approve with conditions, 3) defer, or 4) deny this application after it reaches a conclusion based upon facts presented at the public hearing. Any interested person who may be affected by a Board decision and who intends to participate in the hearing before the Board and present evidence or cross-examine witnesses according to SDCL 1-35, must file a written petition with BOTH the applicant and the Chief Engineer, *May 8, 1986*. The petition may be informal, but it must include a statement describing the petitioner's interest in the application, the reasons for the petitioner's opposition to or support of the application, and the signature and mailing address of the petitioner or his legal counsel if legal counsel is obtained. The applicant need not file a petition.

This application is made by the provisions of SDCL 46-1-1 through 46-1-12; 46-1-13; 46-3-1, 46-3-2, 46-3-3, 46-3-4, 46-3-5, 46-3-6, 46-3-7, 46-3-8, 46-3-9, 46-3-10, 46-3-11, 46-3-12, 46-3-13, 46-3-14, 46-3-15, 46-3-16, 46-3-17, 46-3-18, 46-3-19, 46-3-20, 46-3-21, 46-3-22, 46-3-23, 46-3-24, 46-3-25, 46-3-26, 46-3-27, 46-3-28, 46-3-29, 46-3-30, 46-3-31, 46-6-1, 46-6-2, 46-6-3, 46-6-4, 46-6-5, 46-6-6, 46-6-7, 46-6-8, 46-6-9, 46-6-10, 46-6-11, 46-6-12, 46-6-13, 46-6-14; and Board Rules ARSD 74:02.01:01 thru 74:02.01:15;

This hearing is an adversary proceeding. The applicant or any person, other than the petitioner, has the right to be present or to be represented by a lawyer. These and other due process rights will be forfeited if they are not exercised. Decisions of the Board may be appealed to the Circuit Court and the State Supreme Court as provided by law.

Any person wishing a copy of the Chief Engineer's recommendation, further information on this application or to attend access to the hearing by the handicapped can contact the Water Rights Division, DWRN, Joe Foss Bldg, Pierre SD (605) 773-3352 for assistance prior to the hearing date. The time of the hearing will be automatically extended for at least thirty days upon written request of the applicant or any person who has filed a petition to oppose or support the application. This request for extension must be filed with the Chief Engineer by May 8, 1986.

0112 05-25-86
04-02-86

PROOF OF PUBLICATION

STATE OF SOUTH DAKOTA

County of _____

_____ hereby

certified that attached printed copy of Notice of Hearing to Appropriate

Water was published in the _____

A newspaper of general circulation in the _____ and published on _____

_____ and State of South Dakota _____ was published in the following _____

[Signature]

Notary Public





Department of Water & Natural Resources

1954-2

Joe Foss Building
523 East Capitol
Pierre, South Dakota 57501

Water Rights Division
605 773-3352

JUN 20 1986

Burlington Northern Railroad Company
Box 597
Alliance, Nebraska 59301

Dear Sir:

Enclosed herewith is your Water Permit No. 1954-2 as approved by the Water Management Board authorizing you to construct your water diversion system and the water to beneficial use, not exceeding the limits as specified in said Water Permit No. 1954-2.

Also enclosed is Form 10, Notice of Completion of Works and Application of Water to Beneficial Use, which you are to complete and submit to the Chief Engineer when you have completed the system and/or have put the water to beneficial use. An inspection can then be scheduled so that your Water License may be issued to you, thus completing your acquisition of a Water Right.

Very truly yours,

JOHN HATCH, Chief Engineer
Water Rights Division

JH:MS

enclosure

PLEASE NOTE: Certain changes can be made in your permit within the five year construction period, usually without affecting the priority date provided an application to amend your permit is made within the five year period-i.e. changes in location or number of diversion points (wells) or location of land to be irrigated. Well locations for wells into the same aquifer can be moved up to 660 feet without application.

Applications to amend a permit after the five year construction period will be assigned a new priority date. Applications to change water sources, to add lands or increase original diversion rates, if approved will usually receive the date of the new application as a priority date regardless of the five year construction period.

WNR-809-5/83



NOTICE OF COMPLETION OF WORKS AND/OR APPLICATION OF WATER TO BENEFICIAL USE

Post Office Alliance, NE.

Date July 2, 1986

TO: Water Rights
Joe Foss Building
Pierre, South Dakota 57501

Dear Sirs:

This is to inform you that I have completed the construction of the water diversion system and/or that I have put the water to beneficial use to maximum extent it is going to be used, not exceeding the amounts as specified in Water Right No. 1954-2.

Water Right Permit No. 1954-2 states that the diversion system is to be constructed by 1-30-86, and that the water is put to beneficial use by 2-30-86.

The diversion system was completed on 1-22-86. Applying the water to beneficial use was completed on 3-15-86.

You may schedule an inspection so that the Certificate of Construction and/or the Water License may be issued, thus completing my acquisition of a water right.

R. J. Wojan - Burlington Northern R.R.
(Signature)

WNR-810-7/79
Notice of Completion of Works and/or
Application of Water to Beneficial Use



195623

SOUTH DAKOTA WATER WELL COMPLETION REPORT

10-85

Location SW 1/4 NE 1/4 Sec 18 Twp 6S Rg 1E

County CUSTER

Please mark well location with an "X"

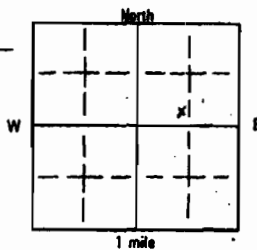

Well Completion Date Sep. 10-86

PROPOSED USE:

- Domestic
- Municipal
- Test Holes
- Irrigation
- Industrial
- Stock

Method of Drilling:

ROTARY MUD

CASING DATA:

- Steel
- Plastic
- Other

If other describe

PIPEWEIGHT	DIAMETER	FROM	TO	MOLE DIAMETER
5/8" 200 LB/FT	6" IN	0 FT	240 FT	8 3/4" IN
5/8" 200 LB/FT	4" IN	200 FT	340 FT	6" IN
_____ LB/FT	_____ IN	_____ FT	_____ FT	_____ IN
_____ LB/FT	_____ IN	_____ FT	_____ FT	_____ IN

GRAOUT:

Was the well grouted? YES NO

To what depth? 340 FEET

What is grouting material? TYPE II CEMENT MIX

If cement, number of sacks? 40

Describe grouting procedure MIXED CEMENT 5 GAL TO 1 BAG CEMENT 4 1/2% GEL PUMPED CEMENT THROUGH CASING & UP OUTSIDE

What was grout weight? 94 LBS TO 5 GAL LB/GAL

SCREEN: Perforated pipe Manufactured

Diameter 4 IN Length 100 FEET

Material 5/8" 200 PVC

Slot Size .064 Set From 240 Feet To 340 Feet

Slot Size _____ Set From _____ Feet To _____ Feet

Slot Size _____ Set From _____ Feet To _____ Feet

Other information PACKERS ON SCREEN 200' 260' 300'

Was packer or seal used? YES NO

If so, what material? NEOPRENE

Describe packer(s) and location? PACKERS ON SCREEN ASSY FOR CENTRALIZERS AND POSSIBLE SAND SCUFF

Was well disinfected upon completion? YES NO

Explain _____ D.D.F. CEMENT MIXED WITH LAST BATCH

Bacteriological analysis YES NO

Laboratory sent to _____

Well Owner:

Name BN RAIL ROAD (ATTN) RL WOLZEN

Address Box 97 Alliance NEB 69301

Well Log: _____ Depth _____

Formation	From	To
SHULL CREEK SHALE	0	90
FALL RIVER	90	180
FUZON	180	190
LAKOTA SHALE LIMBONE-CLAY	190	230
LAKOTA SANDSTONE	230	240
" " "	240	330
SHALE & CLAY	330	340

STATIC WATER LEVEL 267 RUNNING Feet

If flowing: closed in pressure 8 LBS PSI

GPM flow 16 through 6" inch pipe

Controlled by Valve Reducers Other

If other, specify _____

Can well be completely shut-in? YES, SCREEN SYSTEM

WELL TEST DATA:

Pumped

Bailed

Other

Describe: _____

Pumping Level Below Land Surface

_____ ft. After _____ Hrs. pumped _____ GPM

_____ ft. After _____ Hrs. pumped _____ GPM

_____ ft. After _____ Hrs. pumped _____ GPM

REMARKS:



This well was drilled under license # 415

And this report is true and accurate.

Drilling firm RABY DRILLING

Signature of License Representative:

Richard P. Raby

Signature of Well Owner: REPRESENTATIVE

Richard L. Wolzen BNRR

Date Oct 1-86

SOUTH DAKOTA WELL AND TEST HOLE PLUGGING REPORT

10-85

Location SW 1/4 NE 1/4 Sec 18 Twp 65 Rg 1E

County Custer

Please mark well location with an "X"

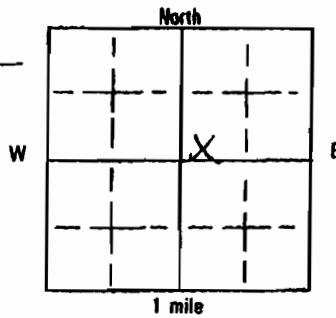

Well Owner:

Name Burlington Northern Santa Fee Railway

Address 80-44th Ave NE, Minneapolis, MN 55421

Plugging completion Date 7-31-98

CHECK APPROPRIATE BOX

EXISTING WELL

TEST HOLE

Well depth 340 ft.

Hole depth _____

Casing material steel

Hole size _____

Casing size(s) 8 5/8" O.D.

Casing condition good

Describe plugging procedure: pressure grouted through tremie line
Filled with cement grout bottom to top w/ 120 sacks
well is in a pit, top of casing at -4 ft. ~~top~~
pit filled in with native material

Describe grout or plugging material: cement grout type I/II
6 gal. water / bag

Type of non-slip plug: none

This well or test hole was plugged under license # 331 And this report is true and accurate.

Drilling firm Taylor Drilling

Signature of Licensed Representative [Signature]

Signature of Well Owner _____

Date _____

TRANSMITTAL LETTER

TO: Mr. Don Stroup
Water Rights Section
30 DEW 12

DATE: June 1, 2001
 PROJECT NO _____
 FROM: John Trumble

Cordilleran Environmental Consultants, Inc.
 7230 W. Ellsworth Ave.
 Lakewood, CO 80226 (303) 274-5583
 FAX (303) 274-9542

PROJECT NAME Well Abandonment - Dewey, SD

RESPONSE REQUIRE YES
 NO

WE ARE SENDING YOU VIA:

EXPRESS COURIER MESSENGER SERV.
 U.S. EXPRESS MAIL HAND DELIVERY
 REGULAR MAIL OTHER

THE FOLLOWING:

ITEM NO.	NO. OF COPIES	DESCRIPTION
1	1	SD well and test hole plugging report

FOR YOUR APPROVAL AS REQUESTED
 FOR YOUR INFORMATION FOR REVIEW AND COMMENT

OTHER _____

REMARKS _____



transct.wk1



CORDILLERAN ENVIRONMENTAL CONSULTANTS, INC.



**DEPARTMENT of ENVIRONMENT
and NATURAL RESOURCES**

JOE FOSS BUILDING
523 EAST CAPITOL
PIERRE, SOUTH DAKOTA 57501-3182
www.state.sd.us/denr

June 11, 2001

MEMO

To: File
From: *Donald E. Stroup*
Donald E. Stroup, DENR Natural Resources Project Engineer
Subject: Permit # 1954-2

I spoke with Burlington Northern Santa Fe Railway personnel at Alliance, NE and Edgemont, SD concerning the use of the well at their Dewey, SD depot. I was advised by the Train Master, Kenny White, at Edgemont that the depot was closed and the well was plugged. I requested and received the attached SD Well and Test Hole Plugging Report from Cordilleran Environmental Consultants. This permit can be cancelled.



**DEPARTMENT of ENVIRONMENT
and NATURAL RESOURCES**

JOE FOSS BUILDING
523 EAST CAPITOL
PIERRE, SOUTH DAKOTA 57501-3182
www.state.sd.us/denr

October 22, 2001

NOTICE OF CANCELLATION

TO: R L Wolzen, Burlington Northern Railroad Company
PO Box 597, Alliance, NE 69301

FROM: Ron Duvall, Natural Resources Engineer
for Garland Erbele, Chief Engineer
Water Rights Program

SUBJECT: Cancellation of Water Permit No. 1954-2

Water Permit No. 1954-2 authorizes diversion of ground water for sanitary purposes in the maintenance building at the Dewey, South Dakota railroad depot. On June 11, 2001, Don Stroup, a staff engineer with our program, met with railroad personnel from Alliance, NE and Edgemont, SD concerning the use of the well at the depot. Don was advised by Kenny White at Edgemont that the depot was closed and the well had been plugged. The Chief Engineer of the Water Rights Program is recommending cancellation of Water Permit No. 1954-2, due to abandonment and/or forfeiture.

The Water Management Board will consider cancellation of Water Permit No. 1954-2 at 10:00 am, December 5, 2001, in the Floyd Matthew Training Center, Joe Foss Building, 523 E Capitol, Pierre, SD.

The recommendation of the Chief Engineer is not final or binding upon the Board. The Board is authorized to 1) cancel, 2) cancel portions of, 3) delay action on, or 4) take no action on Water Permit No. 1954-2 based upon facts presented at the public hearing. Our records show you to be the owner of property covered by this water permit. If you wish to oppose the cancellation and if you intend to participate in the hearing before the Board and present evidence or cross-examine witnesses according to SDCL 1-26, you must file a written petition with the Chief Engineer by November 26, 2001. The petition may be informal, but it must include a statement describing the reasons for your opposition to the cancellation, and your signature and mailing address or your legal counsel if legal counsel is obtained. The Board may consider any abandoned or forfeited water to be available for appropriation subject to the provisions of SDCL 46-1, 46-2, 46-2A and 46-5.

The hearing(s) will be conducted pursuant to the provisions of SDCL 46-1-1 thru 46-1-10, 46-1-14 thru 46-1-15; 46-2-3.1, 46-2-9, 46-2-11, 46-2-17; 46-5-36, 46-5-37, 46-5-37.1; 46-2A-1 thru 46-2A-7; and Board Rules ARSD 74:02:01:36 thru 74:02:01:41. These are contested cases pursuant to procedures contained in SDCL 1-26.



October 22, 2001
Burlington Northern Railroad Co
Page 2

These hearings are adversary proceedings. Any party has the right to be present or to be represented by a lawyer. These and other due process rights will be forfeited if they are not exercised. Decisions of the Board may be appealed to the Circuit Court and State Supreme Court as provided by law.

The time of the hearing will be automatically extended for at least twenty days upon your written request to the Chief Engineer after a petition has been filed to oppose the cancellation. If an extension is requested, the hearing on the cancellation will be continued until the next regular Board Meeting. Any request for extension must be filed with the Chief Engineer by November 26, 2001.

Prior to November 26, 2001, contact the Water Rights Program, Joe Foss Building, 523 E Capitol, Pierre, SD (605-773-3352) if assistance is needed with the following: 1) further information on the proposed cancellation; 2) to assure access to the meeting room for the handicapped; or 3) to obtain an interpreter for the hearing impaired.



**DEPARTMENT of ENVIRONMENT
and NATURAL RESOURCES**

JOE FOSS BUILDING
523 EAST CAPITOL
PIERRE, SOUTH DAKOTA 57501-3182
www.state.sd.us/denr

RECOMMENDATION OF CHIEF ENGINEER

FOR WATER PERMIT NO. 1954-2, BURLINGTON NORTHERN RAILROAD COMPANY

Pursuant to SDCL 46-2A-2 and 46-5-37.1, the following is the recommendation of the Chief Engineer, Water Rights Program, Department of Environment and Natural Resources concerning Water Permit No. 1954-2.

The Chief Engineer is recommending cancellation of the above Water Permit due to abandonment and/or forfeiture. An investigation by Donald Stroup, June 11, 2001, found the well at the Dewey, SD depot had been plugged and the depot was closed.

**RON DUVALL, Natural Resources Engineer
for Garland Erbele, Chief Engineer
October 22, 2001**



**DEPARTMENT of ENVIRONMENT
and NATURAL RESOURCES**

JOE FOSS BUILDING
523 EAST CAPITOL
PIERRE, SOUTH DAKOTA 57501-3182
www.state.sd.us/denr

December 7, 2001

1954-2

NOTICE

R L Wolzen
Burlington Northern Railroad Company
PO Box 597
Alliance, NE 69301

Dear Mr. Wolzen:

This will notify you that the Water Management Board cancelled Water Permit No. 1954-2 on December 5, 2001. The water permit had authorized use of ground water for sanitary purposes in the maintenance building at the Dewey, South Dakota railroad depot.

This action was taken under the conditions outlined in our notice to you dated October 22, 2001. If you have any questions concerning the Board action, please contact Genny McMath, with our program, at (605) 773-3352.

Sincerely,

Garland Erbele, Chief Engineer
Water Rights Program



PLEASE COMPLETE ENTIRE FORM

WELL DRILLERS REPORT
Division of Water Rights
Department of Water & Natural Resources

6/60

Well Owner: Name Silver King Mines
Address: Sisseton, SD

Water Level Information:
Static water level 34 below land surface
If flowing: closed in pressure ___ PSI
rate of flow ___ GPM
Controlled by:
[] Valve [] Reducers [] Other

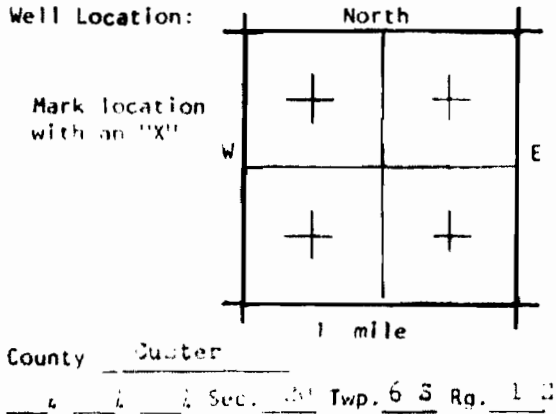

Well Test Data:
[] Pumped
[] Bailed Describe: bailed 7 hrs.
[] Other air lifted 3 hrs.
Pumping Level Below Land Surface
ft. After ___ Hrs. pumped ___ GPM

Proposed Use:
[] Domestic [] Municipal [x] Test Holes
[] Irrigation [] Industrial [] Stock

Well Log table with columns: Formation, From, To, Depth. Rows include: nowery, skull creek, fall river, fusion, lakota, merrison.

Method of Drilling:
[x] Forward Rotary [] Bored [] Jetted
[] Reverse Rotary [] Cable [] Other

Well Construction:
Diameter of Hole 15"
Depth ___
Casing [x] Steel [] Concrete
[] Plastic [] Other
If other, specify ___
Was casing end left open no
Was a well screen installed yes
Describe Well Screen
Diameter 6 5/8 Material gal.
Slot size ___
Was well gravel packed yes
Was well grouted yes
Was water sample taken yes

Date Completed: 10-27-81

Driller: Forward Drilling 412
Driller's or Firm's Name License NO.
2203 Lincoln, Hot Springs, SD
Address
T H Tefertiller 10-12-81
Signed By Date

Remarks:





749-79 Smith & Assoc. Cor. No. #1
 10-31-78 (MENE (SEC 27) T₆₅ 1 R,
 S. Dist. 0-2 surface (65 1 R)
 2-76 Red silty shale streaks of Cyp.
 surface pipe set at 72 ft. Down
 5 ft. cemented with 18 sack bag cement.
 20 ft from surface 9-26 15 ft. cement in
 pipe
 76-95 Red silty shale streaks of Cyp
 95-102 White & pink Cyp.
 107-151 Red silty shale
 151-198 White & gray Cyp.
 194-205 Red silty shale streaks of Cyp
 205-285 hard gray limy Cyp streaks of
~~285-346~~ Red silty shale
 285-396 Red silty shale
 386-427 pink & light lavender limestone
 427-429 Red & lavender limy shale
 429-455 Red silty shale
 455-482 White Cyp. streaks of Red-silty shale
 482-505 Red silty shale
 505-517 white Cyp. streaks of pink limestone
 517-520 Red silty shale test Cyp. 0-20
 520-539 Red sandy shale
 539-541 Pink limestone
 541-570 White & pink sand
 570-592 ANT. hydrite white
 592-621 Pink & lavender limestone
 621-639 Pink sandstone
 639-667 Buff limestone of pink sand
 667-723 Gray limestone
 723-727 Gray shale & calcareous
 727-747 Gray Dolomite & shale
 747-784 Gray & pink dolomite
 cased with 640 ft. 1 1/2 inch black pipe
 cemented @ 40 sacks cement to 5' shows



NOTICE OF WELL CONSTRUCTION

Custer

(1) WELL CONSTRUCTION

Location of well: NW 1/4 NE 1/4 Section 25 Township 6S Range 1E

Well owner Silver King Mines Box 49 Edgemont, South Dakota 57735
(Name) (Address)

Date well drilling completed 7-14-80 Purpose of well observation
(domestic, irrigation, municipal, industrial, other)

WELL LOG

Layers, top to top in feet	Description of layer	Depth to top of water producing aquifer _____ ft.
<u>6-550</u>	<u>dkgy sh & mdst</u>	Depth to static water level <u>flowing</u> _____ ft.
<u>550-599</u>	<u>interbed fgs & sh</u>	Name of producing aquifer (if known) <u>Lakota</u>
<u>599-619</u>	<u>fgs</u>	Total depth of drill hole <u>860</u> _____ ft.
<u>619-622</u>	<u>mdst</u>	Depth to bottom of casing <u>800</u> _____ ft.
<u>622-640</u>	<u>fgs</u>	Casing information: in the space below show kind, size, weight, lengths per diameter, etc., for production casing and surface casing, if used.
<u>640-700</u>	<u>variegated mdst</u>	
<u>700-707</u>	<u>mdst & xlst</u>	Screen information: in the space below show length of screen below bottom of casing, diameter and kind of screen or casing perforations.
<u>707-716</u>	<u>fgs</u>	
<u>716-731</u>	<u>mdst</u>	60 ft. open hole
<u>731-755</u>	<u>fgs w/60' thin mdst layers</u>	
<u>755-767</u>	<u>mdst</u>	shut in pressure <u>3160</u> PSI if a flowing well, flow of completed well _____ G.P.M.
<u>767-815</u>	<u>fgs</u>	
<u>815-820</u>	<u>mdst</u>	<u>Silver King Mines</u> # <u>406</u> Name of Drilling Contractor
<u>820-844</u>	<u>fgs</u>	
<u>844-860</u>	<u>mdst</u>	

(2) PUMP INSTALLATION

Company name and size of pump _____ HP

Type of pump _____ Capacity of installed pump _____ G.P.M.

Depth of pump placement _____ ft., Date of pump installation _____

(3) WATER SURFACE MEASURING TUBE

On some wells an air-tight water surface measuring tube is required. See Section 48.408 of Chapter 48A, MINIMUM WELL CONSTRUCTION STANDARDS.

Show exact vertical length of water surface measuring tube, when installed _____ ft., tube diameter _____

tube material _____

Name of Pump Installation Contractor



POWERTECH (USA) INC.

NO MATCH 2-78-4E LINC

Farm Lynch

Index 2002

County Fall River

Company _____

Sec. 2 T. 78 R. 1E

Drilled by _____

Date _____

Authority Mrs. Lynch (owner)

Type of log _____

Type of drill _____

Samples _____

Elevation _____

by _____

method _____

Remarks Top information obtained verbally April 1952

		?	

1st water — — — — —

Stinking water — — — — —

Well flows size of thumb.

Talks downed site of well from a bottom. Possibly
in wrong. In any case, the flow
can't be enhanced

2nd
Lynch is in
production and the
flow is in the
well is in the
well is in the

177
369



NO MATCH 20-7S-1E TUBBS

1 of 1

Water Tubbs Feb. 4, 1927
Fall River County Sec. 26 Twp. 7S Range 1E

Total Depth 40' Static 26'
Dia. 30"

1-3 top soil
3-26 sand
26-28 gravel
28-4 blue shale

150x

Hydro ID Cross Reference			
Count	Powertech ID	Hydro ID	Log Date
1	DB07-11-2	682	5/24/2007
2	DB07-11-11C	680	10/16/2007
3	DB07-11-14C	684	11/2/2007
4	DB07-11-15	686	11/4/2007
5	DB07-29-7	683	11/19/2007
6	DB07-32-3C	681	11/27/2007
7	DB07-32-5	687	11/17/2007
8	DB08-32-10	689	1/26/2008
9	DB08-1-6	3026	3/24/2008
10	DB08-1-7	703	no date
11	DB08-2-1	698	3/21/2008
12	DB08-5-1	704	4/19/2008
13	DB08-11-17	688	3/25/2008
14	DB08-11-18	690	4/1/2008
15	DB08-11-19	692	4/4/2008
16	DB08-15-2	696	3/11/2008
17	DB08-15-3	694	3/19/2008
18	DB07-32-4C	685	12/4/2007
19	DB08-32-9C	691	1/15/2008
20	DB08-32-11	693	2/8/2008
21	DB08-32-12	697	2/26/2008
22	DB08-32-13	695	3/7/2008
23	DB09-21-1	705	11/19/2009
24	DB09-21-2	706	11/24/2009
25	DB-GW675	675	n/a
26	DB-GW676	676	n/a
27	DB-GW677	677	n/a
28	DB-GW678	678	n/a
29	DB-GW679	679	n/a
30	DB-11-34-ALLUV-4	707	n/a
31	DB-11-3-ALLUV-3	708	n/a
32	DB-11-15-ALLUV-4	709	n/a

This page intentionally left blank

SOURCE D
SOUTH DAKOTA OIL AND GAS RECORDS

This page intentionally left blank



Oil and Gas Search for: <i>api_no_like</i> '40 047 20045'		
Page 1 of 1	<u>Download Database</u> (Excel spreadsheet format)	Page: 1

Record 1 of 1

Well Information

API No:	40 047 20045	County:	FALL RIVER
Well Name:	PETRO LEWIS 5-22 PETERSON	Location:	SWNW 22-7S-1E
Permit No:	606	Total Depth:	2545
Operator Name:	PETRO-LEWIS CORPORATION	Bottom Hole:	Minnelusa
Permit Date:	10-21-1970	KB Elevation:	3542
Spud Date:	11-17-1970	Ground Elevation:	3534
Plug Date:	11-27-1970	Latitude:	43.429484
		Longitude:	-103.992869
Well Field	WILDCAT	Status	P&A
Class:	DRY HOLE	Type:	DRY HOLE

Formation Tops

<u>Formation</u>	<u>Depth (ft.)</u>
Fall River	324
Lakota	452
Morrison	700
Sundance	848
Goose Egg	1441
Spearfish	1704
Minnekahta	1704
Opeche	1738
Minnelusa	1815
Converse	1838
Red Marker	2237
2nd Leo	2353

Page 1 of 1 (goto top)	Page: 1
---	----------------

COUNTY: FALL RIVER
LEGAL LOCATION: SWNW 22-7N-1E
API NO: 40 047 20045
PERMIT NO: 606
WELL NAME: PETRO-LEWIS #5-22
PETERSON
OPERATOR: PETRO-LEWIS
CORPORATION
PERMIT ISSUED: 10/21/1970
PERMIT CLOSED: 12/29/1971
FILE LOCATION: 7N-1E-12 SWNW

TARGET CODES:

WELL HISTORY / CHECKLIST

PERMIT TO DRILL / INTENT TO DRILL

WELL INSPECTION / SCOUT REPORTS

OPERATOR'S TECHNICAL REPORTS / MAPS

ADMINISTRATIVE / SUNDRY REPORTS

CORRESPONDENCE

SURETY

MISCELLANEOUS

WELL HISTORY / CHECKLIST



Well History

Well Name Petro-Lewis #5-22 Peterson Permit No. 606

Location SNW 22-7S-1E Fall River Date of Permit 10-21-70

Elev. 3534' Gr. API No. 40 047 20045

Confidential From To

Logs Received Dual Induction-Laterlog, Sonic-Gamma Ray

Cuttings Received _____ Cores Received _____

Drill Stem Records _____

Cap Plug and Marker Set _____

Surface Restored _____

Plugging Affidavit Signed _____ Date _____

Bond Released YES Date 12-29-71

Summary of Scout Reports

11-27-70 FVS Logging. Drilled to T.D.

6-21-71 RL Site approved.



WELL HISTORY

Well Name Peter Lewis # 5-22 Peterson Permit Number 606
 Location SW NW 22-7a-1E Date of Permit Oct 22, 1970
 Elevation 3542 KB API Number _____
 Confidential Yes From 11-27-70 To 5-27-71
 Logs Received Dual Ind, Sonic Grimme - Ray, sample
 Cuttings Received Yes Cores Received _____
 Drill Stem Records Run Out - No Copy 12-8-70

Cap Plug and Marker Set Approved June 23, 1971
 Surface Restored Approved June 23, 1971
 Plugging Affidavit Signed _____ Date _____
 Bond Released _____ Date _____

Summary of Scout Reports
No Cuttings 29 Apr 1971



PERMIT TO DRILL / INTENT TO DRILL



State Pub. Co., Pierre

APPLICATION FOR PERMIT TO:

S. Dak. Oil & Gas Board FORM 2

<input checked="" type="checkbox"/> DRILL	<input type="checkbox"/> DEEPEN	<input type="checkbox"/> PLUG BACK	FARM OR LEASE NAME
<input type="checkbox"/> OIL WELL	<input type="checkbox"/> GAS WELL	<input type="checkbox"/> SINGLE ZONE	Peterson
		<input type="checkbox"/> MULTIPLE ZONE	WELL NO
OPERATOR			5-22
PETRO-LEWIS CORPORATION			FIELD AND POOL OR WILDCAT
ADDRESS			Wildcat
1224 Denver Club Building, Denver, Colorado, 80202			NO. ACRES IN LEASE
LOCATION (1/8th feet from an established corner of the legal subdivision)			4 1/4 SEC. TWP. RGE
1980' FNL, 660' FWL, SW-NW Section 22, T7S, R1E			SW-NW Sec. 22, T7S, R1E
Fall River County, South Dakota			Fall River
NAME AND ADDRESS OF SURFACE OWNER			NO. OF WELLS ETC.
Mrs. M. Lenore Peterson			3534' Gr.
NAME AND ADDRESS OF CONTRACTOR			PROPOSED DEPTH
Will follow			2490'
IF LEASE PURCHASED WITH ANY WELLS DRILLED, FROM WHOM PURCHASED (Name and address)			NO. OF WELLS ETC.
			Rotary
			APPROXIMATE DATE WORK WILL START
			October 21, 1970

PROPOSED CASING AND CEMENTING PROGRAM					
SIZE OF HOLE	SIZE OF CASING	WEIGHT PER FOOT	NEW OR SECOND HAND	DEPTH	SACKS OF CEMENT
12-1/4"	8-5/8"	24#	New	165' Minimum	To Surface

DESCRIBE PROPOSED OPERATIONS. IF PROPOSAL IS TO DEEPEN OR PLUG BACK, GIVE DATA ON PRESENT PRODUCTIVE ZONE AND PROPOSED NEW PRODUCTIVE ZONE. GIVE BLOW OUT PREVENTER PROGRAM IF ANY

We propose to drill this well with rotary tools to an approximate depth of 2490' to test the Leo Sand. If commercial production is encountered a 5-1/2" OD 14# oil string will be run and cemented with sufficient cement to displace 1000'.

Certified Surveyors plat attached (3 copies)
Blanket drilling bond #1672873

SIGNED R. J. Doubek TITLE Manager of Operations DATE 10/7/70

PERMIT NO. 666 CHECKED BY Policy Handler, Land Date

APPROVAL DATE October 2, 1970 Secretary

CONDITIONS:
 COMPLETE SET OF SAMPLES, AND CORES IF TAKEN, MUST BE SUBMITTED.
 SAMPLES, AND CORES IF TAKEN, BELOW DEPTH, MUST BE SUBMITTED.

INSTRUCTIONS

General: This form is designed for submitting proposals to perform certain well operations, as indicated, on all types of lands and leases for appropriate action by either a Federal or a State agency, or both, pursuant to applicable Federal and/or State laws and regulations. Consult applicable Federal or State regulations, or appropriate officials, concerning approval of the proposal before operations are started.

If the proposal is to re-drill to the same reservoir at a different subsurface location or to a new reservoir, use this form with appropriate notations.

If the well is to be, or has been, directionally drilled, so state and show by attached sheets, if necessary, the coordinate location of the hole in any present or objective productive zones.

File 3 copies of this form with Secretary, Oil & Gas Board, Pierre.

(*Sample location: 800' South and 800' East of the Northwest Corner of Section 16)



R. 1 E.

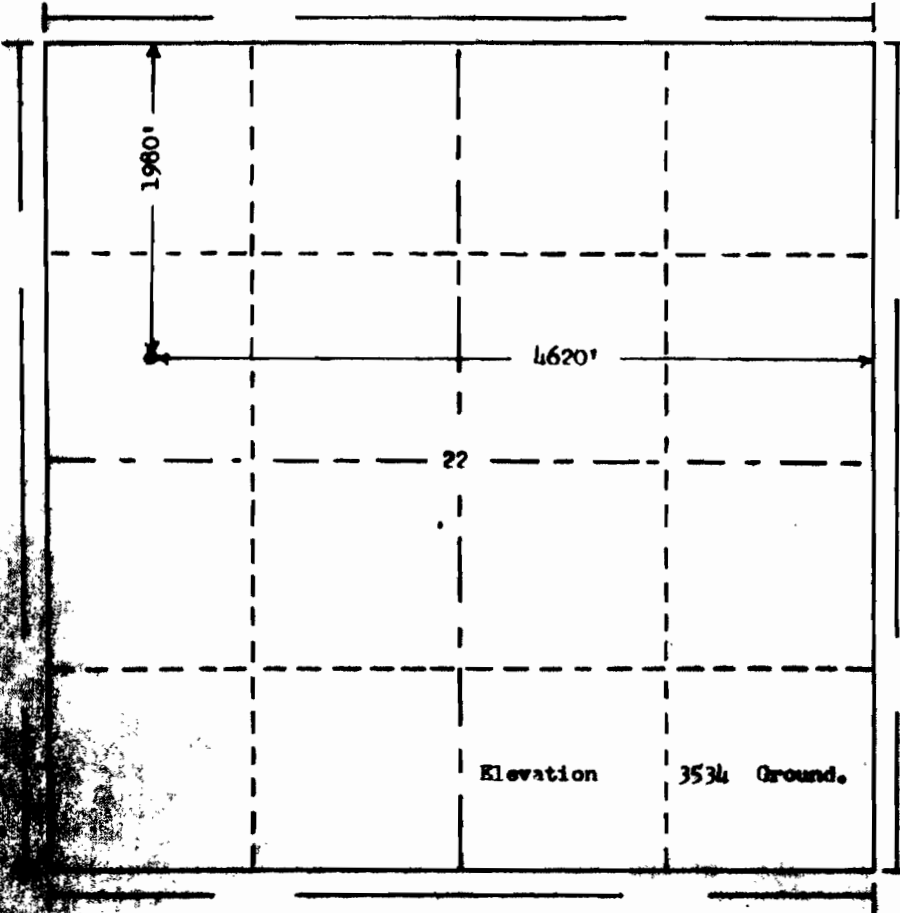

T.
7
S.

Scale... 1" = 1000'

Survey Elevation Company, Inc. of Denver, Colorado
in accordance with a request from Owen Stevens

Petro Lewis Corporation
located the location of #231 Driftwood Area
1980' FN & 4620' PE Section 22 Township 7 S.
1 E. of the Black Hills Meridian
Fall River County, South Dakota

I hereby certify that this plot is an
accurate representation of a correct
survey showing the location of
#231 Driftwood Area

Date: 7-28-70

[Signature]
Licensed Land Surveyor No. 1212 PE
State of South Dakota

STATE PUB. CO., PISHER

ORGANIZATION REPORT

Full Name of the Company, Organization, or Individual

Petro-Lewis Corporation

Post Office Address (Box or Street Address)

122 1/2 Denver Club Building, Denver, Colorado, 80202

Plan of Organization (State whether organization is a corporation, joint stock association, firm or partnership, or individual)

Corporation

If a reorganization, give name and address of previous organization

(1) If foreign corporation, give State where incorporated (2) Name and postoffice address of State agent (3) Date of permit to do business in state

May 28, 1970

Principal Officers or Partners (in partnership) NAME	TITLE	POSTOFFICE ADDRESS
SEE THE ATTACHED SHEET...		

DIRECTORS NAME

POSTOFFICE ADDRESS

SEE THE ATTACHED SHEET

Executed this the 7th day of October, 19 70

State of Colorado

County of Denver

R. J. Doubek
Signature of Affiant R. J. Doubek

Before me, the undersigned authority, on this day personally appeared R. J. Doubek known to me to be the person whose name is subscribed to the above instrument, who being by me duly sworn on oath states, that he is duly authorized to make the above report and that he has knowledge of the facts stated herein, and that said report is true and correct.

Subscribed and sworn to before me this 7th day of October, 19 70.

SEAL
My commission expires Nov. 3, 1971

Betty J. Burrows
Notary Public in and for Colorado
County, Denver

DO NOT WRITE BELOW THIS LINE

PETRO-LEWIS CORPORATION

Attachment to Annual Corporate Report
Attachment dated May 15, 1970

Current Officers of the Corporation:

Title:	Name:	Street Address:	City:	State:
President	Jerome A. Lewis	3680 South Downing	Englewood	Colorado
Vice-President	Don E. Mettler	5741 East Nassau Place	Englewood	Colorado
Vice-President	Dwight C. Moorhead	1437 South Fairfax	Denver	Colorado
Vice-President	David A. Frawley	7343 E. Jefferson Drive	Denver	Colorado
Vice-President	Hal H. Wolfe	800 Lotus Way	Broomfield	Colorado
Vice-President	Herbert G. Allen			Colorado
Vice-President	Jim H. Hanlon	2195 Urban Drive	Lakewood	Colorado
Secretary-Treasurer	Robert B. Huffman	3162 South Gaylord	Englewood	Colorado

Current Directors of the Corporation:

Name:	Street Address:	City:	State:
Jerome A. Lewis	3680 South Downing	Englewood	Colorado
Don E. Mettler	5741 East Nassau Place	Englewood	Colorado
Ted P. Stockmar	15 Cherry Street	Denver	Colorado
W. Dale Schouweiler	5212 Indiana	Fort Wayne	Indiana
Cortlandt S. Dietler	888 Logan Street	Denver	Colorado
Carl K. Erpf	960 Park	New York	New York
James W. Vickers	346 North	Wichita	Kansas



WELL INSPECTION / SCOUT REPORTS



Number 2

SCOUT REPORT
South Dakota Geological Survey

Date Scouted 6-21-71

Operator Petro-Lewis Permit Number 606

Farm/Lease Name #5-22 Peterson API Number 40 047 20045

SW Sec. 22, T. 7S, R. 1E, Fall River County

Elev. 3534, Est. T.D. 2490, Actual T.D. 2545, Spudded 11-18-70

Contractor A. L. Schlaikjer Geologist Al Nelson

WORK IN PROGRESS:

DEVELOPMENTS SINCE LAST VISIT:

FORMATION TOPS:

PLUGGING RECORD:

Date Plugged 11-27-70

CASING RECORD:

4 1/2 From 0 To 367 Feet _____ From _____ To _____ Feet
_____ From _____ To _____ Feet _____ From _____ To _____ Feet

REMARKS:

Site approved. Converted to water well, good running well. Area restored and policed.

SCOUTED BY Ross Lamphere
Ross Lamphere, Ass't. Geologist

Fred V Steece, Jr
Fred V. Steece, Principal Geologist

SCOUT REPORT
South Dakota Geological Survey

Number 1

Date Scouted 11-27-70

Operator Petro-Lewis Permit Number 506

Farm/Lease Name # 5-22 Peterson API Number 40 047 20045

S&W Sec. 22, T. 7S, R. 1E, Fall River County

Elev. 3534 Gr., Est. T.D. 2490, Actual T.D. 2545, Spudded 11-18-70

Contractor A. L. Schlaikjer Geologist Al Nelson

WORK IN PROGRESS:

Logging

DST #1-2381-2395: IHP 1111, FH 1106, IF 20, FF20, IF 30, FF 75, SIP 963, SIP₂ 907, Flow, 15 min, SIP. 15 min, Flow₂ 45 min, SIP₂ 15 min, BHT 96°, mud wt. 9.5, viscosity 60; tool opened w/very weak blow and remained op 5 min, tool op w/very weak blow 1/4" under water, remained for 10 min, then intermittent blow. Rec: 140 fluid; 60' GCM w/sulfur smell, 80' water w/scum of oil and sulfur smelling gas; water flow throughout test; Resistivity: water 40.62 pf cl content 18,000ppm mud pit spl 2.6 @ 60 Of cl content 2,500 ppm.

DEVELOPMENTS SINCE LAST VISIT:

Drilled to T.D.

FORMATION TOPS: (Al Nelson)

Fall River-----324	Gooseegg-----1441	2nd Converse-----1961-1991
Fuson-----452	Forellels-----1599	3rd Converse-----2076-2094
Lakota-----469	Glendo-----1618	4th Converse-----2154-2165
Morrison-----700	Minnekahta-----1704	Red Marker-----2237-2247
Sundance-----848	Opeche-----1738	2nd Leo-----2353
Lak-----966	Minnelusa-----1815	Des Moines-----2416
Basal Sund Sd-----1061	1st Converse-----1838	
Spearfish-----1174	Massive Anhydrite 1911-1942	

PLUGGING RECORD:

Date Plugged 11-27-70

- 40 sax--2410-2300 Leo
- 30 sax--1850-1750 Converse
- 30 sax--1130-1030 Basal Sand

CASING RECORD:

_____ From _____ To _____ Feet	_____ From _____ To _____ Feet
_____ From _____ To _____ Feet	_____ From _____ To _____ Feet

REMARKS:

Plugged back to Morrison, 1/2 casing ran to 367 and well completed as water well for Peterson farm; flows approx. 25.35 gal per min.

SCOUTED BY Fred V. Steece

Fred V. Steece, Principal Geologist



~~Peterson~~ Lewis #5- 2 Peterson
SW NW 22-7S-1E Fall River
1980 FNL and 4620 FEL

10-29-70

No activity, location
staked, but no work
done.

PERMIT: 606 (10-21-70)

11-19-70

API: 40 047 20045

ELEV: 3534 Gr 3542 KB

CONTR: A.L. Schlaikjer 5662-7244

GEOL: Al Nelson ^{Rambona Hotel} Edgemont

ENGR: W.J. Mc Peters

SPUD: 11-18-70 (1:15 AM)

EST T.D.: 2490

CASING: 879-167

CORES: None

DST'S: 2381-2395

LOGS: DIL & Sonic GR

T.D.: 2545 Drlr 2544 Cog

PLUG: 11-27-70

Phone call from
Al Nelson saying
well was started and
that he would let
me know when
ready to plug.
Said, Petro Lewis plans
3 tests in Edgemont
area.

11-26-70

Nelson called saying
would be logging
late tonight, ready
to plug in A.M.



Hydro ID 3

15 of 69

Plug Program:

40 day	2410-2300	Leo
30 day	1850-1750	Cover
30 day	1130-1030	Road

blow and remained -
op 5 min, tool open very weak
flow 1/4" under water,
remained for 10 min, then
intermittent flow. Try passed

Plan to run 360 - 4 1/2
casing and convert to
water well. Schlumberger w/
do this before they
tear down.

to see if plugged. Rec
140 fluid; 60' gas GCM
w/sulfur smell, 80' water w/
smell of oil & sulfur smelling
gas. Water flowed through
out test.

DST #1 (Leo Sand)
2391-2395:
HP III, FH 1106, IF 20
FF 20, IF 30, FF 75, SIP, 963,
SIP, 907, Flow 1.5 min,
SIP 1 - 15 min, Flow 2 - 45 min,
SIP 2 - 15 min, BHT 96, Mud
wt 9.5, viscosity 60; Tool
opened with a very weak

Resistivity: water 4 @ 62
of Cl content 18,000 ppm
mud pit spl 2.6 @ 60 of
Cl content 2600 ppm



Formation ops.

Kd	324
Fuson	447 452
Lakota	588 469
Morr.	700
Sund	848
Lak	966
Basal Sd.	1061
Spear	1174
Gooseg	1441
Forelle Lime	1599
Glendo Sh	1618
Mk	1704
Opedhe	1738
Mimnelusa	1815
1st Converse	1838
Massive Halysite	1911
Boise "	1942
2 nd Converse	1961 - 1991

3 rd Conw	2076 - 2094
4 th Conw	2154 - 2165
Basal Conw	2226
Red Mark	2237 - 2247
2 nd Leo	2353 -
Des Moines	2416
TD	2545 Driller
	2544 Log
Site Imp.	
Converted to H ₂ O well in a good running well. Area is restored not seal level. area paved.	

Page:

OPERATOR'S TECHNICAL REPORTS / MAPS



PHONE 522-1206 AREA 303

VIRG'S TESTERS, INC.

BOX 712 STERLING, COLORADO

Contractor A. L. Schlaikjer, Inc. Top Choke 1"
 Rig No. 4 Bottom Choke 9/16"
 Spot SW-NW Size Hole 7 7/8"
 Sec. 22 Size Rat Hole None
 Twp. 7 S Size & Wt. D. P. 3 1/2" 13.30
 Rng. 1 E Size Wt. Pipe None
 Field Wildcat I. D. of D. C. 2 1/2"
 County Fall River Length of D. C. 512'
 State South Dakota Total Depth 2395'
 Elevation 3534' "Ground" Interval Tested 2381-2395
 Formation "2nd Leo" Sand Type of Test Straight
 Tool Open @ 10:00 A.M.
 Flow #1 5 Min. SIP #1 15 Min. Flow #2 45 Min SIP #2 15 Min.
 Flow #3 _____ Min. SIP #3 _____ Min. Flow #4 _____ Min. SIP #4 _____ Min.
 B. H. T. 96° Gravity _____
 Mud Wt. 9.0 Viscosity 60

TOOL SEQUENCE

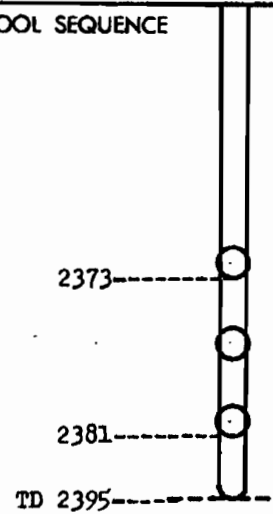

Operator Petro-Lewis Corp.
 address See Distribution

Well Name and No. Peterson #5-22
 Ticket No. 0786
 Date 11-25-70

DST No. 1
 No. Final Copies 10

T-0786

R-4153-N

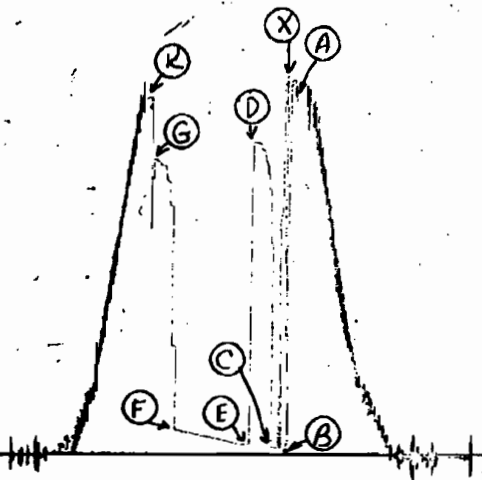

PRD Make <u>Kuster AK-1</u>			
No.	Cap.	2000	@ 2361
Press	Field	Corrected	
IH	A	1111	1102 ✓
FH	K	1106	1100 ✓
Flow #1-IF	B	20	1 ✓
FF	C	20	21 ✓
SIP #1	D	963	969 ✓
Flow #2-IF	E	30	31 ✓
FF	F	75	76 ✓
SIP #2	G	907	914 ✓
Flow #3-IF	H	None	Taken
FF	I	"	"
SIP #3	J	"	"
Pressure Below Bottom Packer Blsd To			
Our Tester: <u>Lloyd Welty</u>			
Witnessed By: <u>S. A. Nelson</u>			

RECOVERY IN PIPE

DID WELL FLOW - Gas No Oil No Water No

140' Total fluid
60' Gas-cut mud with a sulphur smell = .29 Bbl.
80' Water with a scum of oil & sulphur smelling gas = .39 Bbl.

REMARKS:

1st Flow - Very weak blow throughout period.
2nd Flow - Tool opened with a very weak blow (3/4" under water), remained for 10 minutes, then decreased to intermittent blow for remainder of test.
By-passed tool after 50 minutes (point "X") to see if it was plugged.
Well had 3" to 4" water flow from annulus throughout test. 3' fillup on bottom.
Breakdown of Shut-in curves not practical because of very bad stair-stepping on Shut-in curves, caused by tight formation.

TIGHT HOLE



Phone 522-1206

VIRG'S TESTERS, INC.

Box 712 - Sterling, Colo.

Fluid Sample Report

Date 11-25-70 Ticket No. 0786
 Company Petro-Lewis Corp.
 Well Name & No. Peterson #5-22 DST No. 1
 County Fall River State South Dakota
 Sampler No. 02 Test Interval 2381-2395

Pressure in Sampler 11 PSIG BHT 96 OF

Total Volume of Sampler: 2150 cc.
 Sample: 2150 cc.
 Oil: 10 cc.
 Water: 2140 cc.
 Mud: None cc.
 Gas: None cu. ft.
 Other: None

Resistivity

Water: 1.4 @ 62° of Chloride Content 17,200 ppm.

Mud Pit Sample 2.6 @ 60° of Chloride Content 2,550 ppm.

Gas/Oil Ratio _____ Gravity _____ °API @ _____ OF

Where was sample drained Rig Floor

Remarks: _____

DISTRIBUTION OF FINAL DST REPORTS

Company Operating Well Petro-Lewis Corp. Tkt. No. 0786
Lease Peterson Well No. 5-22 Field Wildcat
County Fall River State South Dakota Sec. 22 Twp. 7 S Rng. 1 E Spot SW-NW
DST. No. 1 Date of Test 11-25-70 Interval Tested 2381-2395

BE SURE AND SHOW CORRECT ADDRESS AND NUMBER OF COPIES. STATE ADDRESS TO WHICH ORIGINAL CHART WILL BE MAILED.

- ✓ Original & 5 copies: Petro-Lewis Corp., 1224 Denver Club Bldg., Denver, Colo. 80202
- ✓ 2 copies: Amarillo Oil Co., Box 151, Amarillo, Texas 79105
- ✓ 1 copy: George Wolf, 811 1st Nat'l Bank Bldg., Casper, Wyo. 82601
- ✓ 1 copy: John Trotter, 313 Consolidated Royalty Bldg., Casper, Wyo. 82601
- 1 copy: Al Nelson, 408 Majestic Bldg., Denver, Colo. 80202

Our Tester _____ Approved by _____

G. ALLAN NELSON

21 of 89

408 CONSULTING PETROLEUM GEOLOGIST
ROOM 408, MAJESTIC BLDG. CODE 303
~~303-336-255~~ 255-7750 Res. 322-0325
DENVER, COLORADO, 80202

1971

GEOLOGICAL WELL REPORT

PETRO-LEWIS
#5-22 PETERSON

C SW NW SEC. 22, T. 7 S., R. 1 E.
FALL RIVER COUNTY, SOUTH DAKOTA

(Wildcat)



INDEX

	<u>Page</u>
Well Data	2
Log Formation Tops	6
Sample Lithologic Description	9
Drill Stem Test	27
Log Calculations	29
Hole Deviation Surveys	30
Bit Record	31
Drilling Progress Summary	32

WELL DATA

LOCATION: 4620' from the East line and 1980' from the North line, C SW NW of Section 22, Township 7 South, Range 1 East, Fall River County, South Dakota.

ELEVATION: 3534 ground (before and after grading).
3542 kelly bushing (7.6' from ground to K.B.).
(Surveyed by Powers, 7-24-70).

TYPE WELL: Wildcat (Driftwood Canyon Prospect).

SPUD DATE: 1:15 A. M., November 18, 1970.

COMPLETION DATE: Approximately 5:00 P. M., November 27, 1970
(Finished plugging).

CASING RECORD: Ran 4 joints of new 8 5/8" surface casing, totalling 167', 8 round, 20 pound. Cemented with 100 sax regular cement with 3% Calcium chloride (Plug down at 10:15 A. M., November 18, 1970. Cement circulated). Pipe set at 177 K. B.

TOTAL DEPTH: 2545 Driller.
2544 Schlumberger.

DEEPEST FORMATION PENETRATED: Pre-Second Leo Sand (Des Moines or older).

DEPTH DATUM: 3542 K. B.

WELL STATUS: Plugged and abandoned (Landowner ran pipe into Dakota Sand to complete as flowing water well from Dakota-Lakota).

MUD PROGRAM: Mixed mud while drilling surface hole to combat lost circulation in river bed sands and gravels; mixed gel. Came out from under surface with native mud and gel and water and a 32-33 vis. Make-up water from nearby Beaver Creek.



WELL DATA (Continued)

Jetted pits at 953 in Sundance in order to convert to red bed type mud. Added 4 sacks of Caustic, 2 sacks of Soda Ash, and 6 sacks of Stabil-Vis. Requirements: 32-35 vis., wt. low as possible. On first trip below surface at 1086 in Sundance hole was flowing a 2" stream of water.

HOLE SIZE: 12 1/4" from surface to 178.
7 7/8" from 178 to 2545 T. D.

CORES: (None).

DRILL-STEM TEST: D.S.T. #1 2379-93 P. D. (Second Leo Sand).

LOGS: Ran Schlumberger Dual Induction-Laterolog first, running a logarithmic 5" and a logarithmic 2" from 2544 T. D. up above the Minnekahta. Then dropped back to bottom and came up to 1736 just above base of Opeche with another logarithmic 5" (repeat) and a linear 2". From above the Minnelusa ran a linear 2" and a linear 5" to base of surface casing at 177 K. B.

Second logs run consisted of the Borehole Compensated Sonic Log with Gamma Ray-Caliper Logs. Ran 5" Sonic, etc., from 2544 T. D. up above Minnelusa to 1732. Then ran a 5" repeat over same interval to see if variance was above 2%. Sonic was repeating good in Minnelusa so continued all the way out to base of surface casing at 177 K. B., running a 5" and 2".

At approximately 1700 added 2 sacks of C.M.C. (Driscose) to lower water loss to 10 cc. or less going into Minnelusa Converse section. At 2206 in lower Converse added 1320 gallons of #2 Diesel to speed drilling and prevent drill column getting stuck in hole. At approximately 2150 added 2 sacks of C.M.C. to lower water loss to 5 cc. or less for drilling Leo Section of Minnelusa. In this part



WELL DATA (Continued)

of section vis. was 38-40, wt. 9.9, Ph. 9.5 or more. Raised vis. to 72 for D.S.T. of Second Leo Sand.

Raised vis. with Gel and detergent for logging at 2545 T. D. Could not get vis. above 44 due to Dakota-Lakota water flow in upper hole; had no problems logging.

Mud furnished by American Mud Company, Gillette, Wyoming. Mud checks on location made every 1-2 days by engineer, Dick Myers, Gillette.

Est. mud bill at 2540, 5' above T. D.: \$3,344.35.

Logging truck and personnel from Gillette, Wyoming. Engineer: Mr. Golas. (Calculations in rear of report).

PLUGGING RECORD:

40 sacks from 2420 to 2300 across Red Marker.
30 sacks from 1850 to 1750 across top of Converse.

30 sacks from 1130 to 1030 across Basal Sand of Sundance.

Cementing by Halco.

Finished plugging at approximately 5:00 P.M., November 27, 1970. (Left Dakota-Lakota open for flowing water well for landowner; contractor ran pipe into Dakota).

CONTRACTOR AND RIG EQUIPMENT:

Schlaikjer Drilling Company, Newcastle, Wyoming.

Pusher: C. W. McPeters, part owner.

Rig. No. 4.

Spencer-Harris 6000 - Made in 1969 (trailer-mounted rig).

Spencer-Harris 97' derrick (pulls doubles) and trailer.

Bethlehem S-45E with 15" double T. W. in Hydromatic.

WELL DATA (Continued)

- 1 335 H.P. Cummins Diesel engine powering drawworks.
- 1 D-300 Emsco mud pump, 7 1/4" x 14", with 5 1/2" liners.
- 2 6-71 (twins) G.M.C. engines with H.D. gear box, 300 H.P., powering mud pump. Space-Saver Cameron S.S. 8" blow-out preventer with 2 valve Cameron hydraulic closing unit.
- 19 5 1/2" O.D. drill collars with 2 1/4" bore.
- 6,000' 3 1/2" I.F. Reed drill pipe with square shoulder tool joints.
Caterpillar D-315 generator with 25 K.W. gas engine standby.
32' trailer house.
- 1 auxiliary 4 x 6 Gardner-Denver mud-mixing pump.
New General Electric 2-way radio system on rig, in pusher's car, and in Newcastle office.

SAMPLE STORAGE:

Samples were shipped to American Stratigraphic in Casper where library cut will be made. Operator's complimentary cut will be sent to South Dakota Geological Survey as required.

DRILLING TIME RECORDS:

Original copy of Geograph 1' drilling time charts is on file in Denver office of G. A. Nelson.



LOG FORMATION TOPS

All depths are measured from 3542 K. B.

<u>FORMATION</u>	<u>DEPTH</u>	<u>DATUM</u>
LOWER CRETACEOUS		Surface
MOWRY SHALE		Surface
MUDDY SAND (NEWCASTLE)		(Behind pipe in surface hole)
SKULL CREEK SHALE		(Behind pipe in surface hole)
DAKOTA FORMATION (FALL RIVER FORMATION)	324	+3218
FUSON SHALE (FUSON MEMBER OF LAKOTA FORMATION)	452	
LAKOTA SANDS	469	+3073
UPPER JURASSIC	700	+2842
MORRISON FORMATION	700	+2842
SUNDANCE FORMATION	832	+2710
REDWATER SHALE MEMBER	832	
LAK MEMBER	966	
TENTATIVE HULETT SAND	1061	
BASE OF SAND	1092	
TENTATIVE STOCKADE BEAVER SHALE	1092	
TENTATIVE TOP OF BASAL SAND	1144	
TRIASSIC	1174	+2368
SPEARFISH FORMATION	1174	+2368
PERMIAN	1441	+2101

LOG FORMATION TOPS (Continued)

<u>FORMATION</u>	<u>DEPTH</u>	<u>DATUM</u>
GOOSE EGG FORMATION	1441	+2101
FORELLE LIME MEMBER	1594	
GLENDO SHALE MEMBER	1618	
MINNEKAHTA LIME MEMBER	1704	+1838
OPECHE SHALE MEMBER	1738	
MINNELUSA FORMATION (REWORKED MINNELUSA)	1815	+1727
UPPER MINNELUSA (PERMIAN)	1815	+1727
FIRST CONVERSE SAND	1838	+1704
MASSIVE ANHYDRITE	1911	
BASE ANHYDRITE	1942	
SECOND CONVERSE SAND	1961	
BASE OF SAND	1991	
TENTATIVE TOP OF THIRD CONVERSE SAND	2089	+1453
BASE OF SAND	2094	
FOURTH CONVERSE SAND	2154	+1388
BASE OF SAND	2165	
BASAL CONVERSE SAND	2226	
RED MARKER	2237	+1305
BASE RED MARKER	2247	
PENNSYLVANIAN	2247	+1295
MIDDLE MINNELUSA (LEO SECTION)	2247	+1295
VIRGIL	2247	+1295
MISSOURI	2353	+1189
SECOND LEO SAND	2354	+1188



LOG FORMATION TOPS (Continued)

<u>FORMATION</u>	<u>DEPTH</u>	<u>DATUM</u>
BASE OF SANDS	2396	
DES MOINES (?)	2416	+1126
TOTAL DEPTH DRILLER	2545	
TOTAL DEPTH SCHLUMBERGER	2544	

SAMPLE LITHOLOGIC DESCRIPTION

All depths are from 3542 K. B.

All sample depths following have been corrected for lag, and then matched to drilling time breaks wherever possible. *Sample lithology is then matched to log lithology so all lithology following matches log.

All shows are underlined with a solid line. Possible shows are shown with a dashed line.

<u>DEPTH</u>	<u>LITHOLOGY</u>
Surface	LOWER CRETACEOUS
Surface	MOWRY SHALE (Surface pipe to 177 K. B.; Muddy Sand or Newcastle Sand probably behind surface pipe). (Samples below are caught and described every 30').
180-200	Silty shale, steel gray, very soft Skull Creek; muddy cave: sandstone, gray, dark gray, shaly, dirty, limy, glauconitic, biotitic, very hard and tight; trace light gray inoceramus prism veinlet on same gray shale; trace sandstone, light gray, very fine, soft, porous; no fluorescence.
200-32	Same shale.
232-64	Same dark steel gray, very soft shale.
264-324	Same shale; trace light brown inoceramus prisms; trace loose pyrite.
324 (+3218)	DAKOTA FORMATION (FALL RIVER FORMATION)
324-28	Abundant sandstone, light gray, lot of sandstone laminated with black silty shale, no show, slightly dirty, very fine to fine, well-cemented, poor visible porosity, hard to soft, also gray; sandstone, fine, soft, porous, no show, white, friable; loose pyrite, crystalline to sandy with embedded sand grains; all with no fluorescence.

- Shaly siltstone, light gray with thin blackish shaly laminations; sandstone, fine, slightly sugary, visible porosity, some glauconite, no show, soft, also very fine, light gray, few carbonaceous spots; also dark gray, very shaly siltstone; sandstone has spotty white cementation; no fluorescence; in stoppered shell vial Dakota cuttings above 354 are cut in C. Tet. solution with no fluorescence in resulting solution; this indicates no oil in samples.
- 354-78 Abundant shaly siltstone, dark gray; some friable, porous sand as above, no show; first traces of waxy clay, tannish light gray, grayish brown and gray (possibly Fuson); lot of small black carbonaceous spots and streaks in siltstone, no visible porosity, no show, no fluorescence.
- 378-452 Same dark gray shaly siltstone and fine light gray sandstone as above with good porosity, soft, white clay spots, no show; limited same waxy clay, tannish gray mottled with black (Fuson?); very shaly siltstone, gray mottled blackish, hard, tight; gray waxy clay.
- 452 FUSON SHALE
- 452-55 Abundant very soft clay, waxy, light gray, tannish light gray, whitish; grayish light green, very waxy, very soft; part sandy where light gray.
- 455-469 Same whitish, light gray clay; also mostly grayish purple and red.
- 469 (+3073) LAKOTA SANDS
- 469-98 Abundant snow white sandstone, highly kaolinitic with abundant white waxy clay cementation, no show, non-calcareous, very fine to fine, no visible porosity, mushy soft, abundant pyrite, few fine grains (Lakota top marked by extremely fast drilling).
- 498-522 Same as above, mostly loose sand grains, clear, very fine to fine to fine-plus, unconsolidated, few medium grains; very abundant pyrite; limited light gray sandstone, no show, fine, cleaner, friable, porous; all with no fluorescence; shale breaks of very waxy clay, bluish white, very pale green; trace chert, smoky gray with tiny white spots, very coarse, subangular.



- 522-45 Traces sandstone, slightly tannish light gray possibly stained, very fine to mostly fine, excellent visible porosity, friable, no fluorescence; abundant very sandy lime, grayish tan, very hard, dense, earthy; abundant loose pyrite, limited medium crystalline, mostly very sandy with embedded sand grains, very fine to fine, part all fine-plus; abundant chert, light gray translucent, tan; loose clear quartz sand grains, fine to medium to medium-plus.
- 545-77 All very dark gray shale (sand on log), slightly waxy, almost black, part slightly sandy; traces conglomeratic sandstone, clean, very sugary, fine to medium, no show; trace loose clear chert, coarse, angular, also frosted, milky white; ironstone (?) stringer, tannish brown, part very sandy, dense, very hard (Morrison-type shale).
- 577-620 Same greenish black shale, slightly waxy, very soft; trace chert, clear, angular, very coarse; traces brown sand, very fine, very well-cemented, no show, no visible porosity, very hard, tight, limy.
- 620-48 Abundant pebbles, mostly very coarse-plus, sub-angular, brown, milky white, clear angular; loose pyrite (pebbles surface cave?); same shale.
- 648-62 (Poor sample, mostly cave).
- 662-700 Loose chert, clear, pink opaque, yellow, subangular, very coarse to pebble size; loose sand grains, very poorly sorted very fine, fine, medium, coarse, very coarse, mostly clear; abundant loose pyrite.
- 700 (+2842) JURASSIC
- 700 (+2842) MORRISON FORMATION
- 700-42 Abundant pale green waxy clay, very soft, with embedded tan lime spots.
- 742-74 Same green clay; increasing tan dense lime.
- 774-803 Same green clay, becoming dark gray; limited limestone stringers, tan with green spots; traces sandstone, gray, light gray, very fine to fine, no show, no visible porosity, hard, tight, limy cementation.
- 803-32 Limestone, very light tan, cream, very dense, very hard; traces dark brown limestone, highly microfossiliferous, hard; trace sandstone, cream, very limy, very fine, very well-cemented, scat-

tered orange grains, no visible porosity, hard, tight.

832 (+2710) SUNDANCE FORMATION

832 REDWATER SHALE MEMBER

832-33 Trace dark gray shaly siltstone, highly glauconitic with dark green grains, very soft; trace shaly siltstone, greenish gray, highly glauconitic, very fine and finer grains.

833-86 (Missing samples).

886-920 Silty shale, dark gray, very soft; very shaly sand to siltstone, dark gray, very, very fine where sand, very silty, highly biotitic and glauconitic, very soft, no porosity.

920-40 Waxy shale, pale green, very soft; dense limestone stringer, light gray, very hard; sandstone, light gray, very fine and finer, limy, scattered dark green glauconite grains, slightly soft.

940-66 Same waxy green shale; same very, very fine sandstone, cream, limited glauconite, no show, soft to slightly soft, no porosity.

966 LAK MEMBER OF SUNDANCE

966-70 Very shaly sand, dark orange, very fine and finer, excellent sorting, no visible porosity, no show, slightly soft; very silty shale, orange red, soft.

970-98 Same sand, orange brown, very fine, no show, soft.

998-1002 Waxy shale, dark gray to blackish.

1002-52 Black waxy shale, very soft.

1052-61 TENTATIVE HULETT SAND

1061-76 (Circulated 20" sample at 1076 before trip for bit in prospective zone). Traces light gray sandstone, very, very fine, excellent sorting, no show, friable, porous; also slightly greenish light gray sandstone, very fine to very, very fine, excellent sorting, no show, glauconitic, porous, soft to slightly soft where more cemented, no fluorescence.

1076-92 Same as above, becoming slightly shalier grayish; trace very pale green waxy shale laminations on sand; all with no show; trace light gray sandstone, very fine, excellent sorting, no show, well-cemented but porous, soft; all with no fluorescence.



1092	TENTATIVE STOCKADE BEAVER SHALE
1092-1144	(Shale on log).
1144	TENTATIVE TOP OF BASAL SAND OF SUNDANCE
1144-74	Sandstone, clean, friable, excellent visible porosity; traces tannish light gray sandstone, very fine, excellent sorting, spotty clay cementation in part.
1174 (+2368)	TRIASSIC
1174 (+2368)	SPEARFISH FORMATION
1174-1207	Smooth shale, red, part silty, all soft.
1207-37	Abundant silty shale, brownish red, finely biotitic, few small light gray spots.
1237-68	Same silty shale, orange red, brownish red, finely biotitic, soft to slightly soft.
1268-1304	Same shale, traces sandy.
1304-36	Same shale, trace greenish gray large spot.
1336-67	Same shale and silty shale.
1367-97	Same shale; trace fibrous white anhydrite veinlet in shale.
1397-1441	Same silty shale, brownish red, orange red; traces loose white fibrous anhydrite; traces white anhydrite inclusions in shale.
1441 (+2101)	PERMIAN
1441 (+2101)	GOOSE EGG FORMATION
1441-48	(7' of slower drilling). (Probably anhydrite --none visible in samples).
1448-61	Silty shale, brick red; small round light green spots in smooth red shale.
1461-81	Silty shale, brick red.
1481-96	Anhydrite, white, orange white, dense, hard.
1496-1524	Silty shale, orange red, white anhydrite inclusions; anhydrite, white, grayish white, dense, hard; white fibrous anhydrite trace, veinlet.
1524-94	Same shale, orange red, few small round light green spots; anhydrite interbeds, white, gray, dense, as above.
1594	FORELLE LIME MEMBER OF GOOSE EGG



1594-98	Abundant anhydrite, white mottled violet dense, hard; trace dolomite, bright orange adjacent to cream, dense, hard.
1598-1604	Anhydrite, white mottled with purple, dense, hard, becoming very shaly dark purple.
1604-14	Trace tan lime, dense, flaky; traces pink dolomitic lime to limy dolomite.
1614-18	Traces limestone, dolomitic limestone, cream, dense, very hard; trace dark tan dense lime.
1618	GLENDON SHALE MEMBER OF GOOSE EGG
1618-25	Shale, silty, finely sandy, dark orange, soft to hard.
1625-41	Same shale, very silty, few anhydrite inclusions and streaks.
1641-48	Same shale.
1648-59	Same shale; trace whitish anhydrite inclusion.
1659-67	Same as above; few white anhydrite inclusions, few small light green round spots.
1667-77	Same orange red silty shale with few white anhydrite inclusions.
1677-90	Same as above, trace anhydrite as veinlet on shale.
1690-1708	(Missing due to no circulation for sample just before trip at 1708 in nonprospective zone).
1704 (+1838)	MINNEKAHTA LIME MEMBER OF GOOSE EGG
1708-13	Limestone, cream to white chalky soft grading into tannish brown dense hard; trace light red slightly chalky limestone; trace dark orange anhydrite, very hard.
1713-22	Pink dense limestone, hard; tannish pink limestone, dense hard; also lime, chalky white to dense tan.
1722-38	(Missing).
1738	OPECHE SHALE MEMBER OF GOOSE EGG
1738-40	Silty shale, brownish red, reddish brown.
1740-49	(Poor sample, mostly cave).
1749-59	Silty shale, orange, orange red, soft to slightly soft.
1759-69	Silty shale, brick red, soft.
1769-79	Silty shale, brick red, soft to slightly soft, few greenish gray spots.



- 1789-1815 Top 4' white anhydrite, microcrystalline, soft, to dense gray; bottom 6' same silty shale as above, few white anhydrite inclusions, small round green spots also; trace very sandy anhydrite to anhydritic sand trace, light gray, fine to fine-plus grains which powder under pressure. Same brick red silty shale with few green small round spots; abundant white anhydrite, microcrystalline, part dense gray, hard.
- 1815 (+1727) MINNELUSA FORMATION (REWORKED MINNELUSA)
- 1815 (+1727) UPPER MINNELUSA (PERMIAN)
- 1815-16 Trace very shaly sand, fine, orange, soft, no show, no visible porosity; trace dark brown possibly stained sand, very quartzitic, very fine, excellent sorting, no visible porosity, very hard and tight, tiny pyrite specks, very well-cemented, to quartzite, no fluorescence.
- 1816-27 (No consolidated sand). Loose sand grains, light orange clear, poorly sorted very fine to fine to medium to medium-plus, also all clear, subround to round.
- 1827-33 Trace grayish tan possibly stained sand, very fine, well sorted, very well-cemented, no visible porosity, dolomitic cementation in part, trace pyrite speck; traces very anhydritic sandstone, conglomeratic, very poorly sorted very fine to fine to medium grains, light orange grains, * like those disintegrated just above, in white anhydrite matrix, no show, very well-cemented, no visible porosity, hard to slightly soft; all with no fluorescence.
- 1833-38 Trace same shaly sand as above, very fine to fine grains in orange red shaly matrix, no visible porosity, very well-cemented, no show, slightly soft, light orange clear grains when disintegrated, no fluorescence.
- 1838 (+1704) FIRST CONVERSE SAND
- 1838-43 (Fast drilling of 1+"/ft. suggests soft, porous sand). (Poor sample, mostly Sundance cave due to water-flow from Dakota-Lakota thinning mud or mudcake). Traces white anhydritic sandstone, very fine, clear grains, soft, no show, to fine, sugary, clean, excellent visible porosity, non-

- calcareous, loosely consolidated; traces dark red very shaly sandstone, very fine, well-cemented, less porous, no show, same as white sand but abundant red silty shale spots; all with no fluorescence.
- 1843-52 Same as above, mostly clean, white, light gray sugary sandstone, very anhydritic cementation, non-calcareous, fine to fine-plus, clear round to subround grains, excellent visible porosity, traces red shaly sandstone, very fine; all with no show, no fluorescence.
- 1852-56 (Slower drilling, tighter sand). (Poor sample due to abundant Sundance cave from water flow uphole). Traces same white sandstone, no show, fine, friable, no show, excellent visible porosity, no fluorescence.
- 1856-70 (Mostly very rapid drilling like very soft, porous sand). (Very poor sample, all cave, no visible sand or sand grains).
- 1870-94 (Same rapid drilling like very soft, porous sand). (Very poor sample, all cave, no visible sand nor sand grains).
- 1894-1911 (Top slower drilling like tight sand or anhydrite-dolomite; bottom fast drilling like soft, porous sand).
- 1911 **MASSIVE ANHYDRITE**
- 1911-21 Anhydrite, all hard, white finely crystalline to denser tannish cream, grading into very anhydritic dolomite, pinkish tan, and chalky white limestone; also white anhydrite mottled with orange to reddish denser anhydrite.
- 1921-29 Anhydrite, snow white, microcrystalline, slightly soft, to denser gray, hard, with tiny round white spots embedded; trace red silty shale on white anhydrite; trace white anhydrite with red shaly anhydritic dolomite.
- 1929-42 (Circulated 20" sample at 1945 just before trip for bit). Very dense hard anhydrite, white to denser orange red to purplish red; also chalky dolomite, dark pink, silty, limy where whiter, all purplish pink, slightly soft.
- 1942 **BASE OF ANHYDRITE**
- 1942-45 (Missing due to intentionally not circulating longer).

- (Poor sample, mostly cave following trip at 1945). Dolomite, anhydritic dolomite, tan, cryptocrystalline, distinctive tiny red silty shale spots scattered in part.
- 1956-60 (Missing).
- 1960-61 Tan anhydritic dolomite; mostly pink slightly silty anhydritic dolomite with light red shaly streaks, few small clear finely crystalline anhydrite spots.
- 1961 SECOND CONVERSE SAND
- 1961-65 Trace sandstone, light orange, very fine to fine, well-cemented but soft, no show, anhydritic cementation, light orange clear grains, no fluorescence, trace dolomitic cementation, porous, few small white spots.
- 1965-85 (1965 top of best porosity, breakdown to less than 1"/ft. from 1965 to 1968, same from 1970 to 1977, and from 1980 to 1985). (Very poor sample, mostly Sundance cave). Trace sandstone, white, very fine, friable, excellent visible porosity, no show; trace reddish orange sandstone, very fine, excellent sorting, shaly, no visible porosity, no show, silty; all with no fluorescence; trace same light orange sandstone; loose grains very fine to fine, light orange clear, subround.
Increasing sandstone, tannish light gray, possibly stained, as above, very fine, well-sorted, porous, friable, becoming less sorted very fine to fine, slightly dolomitic cementation, slightly yellowish, clear grains slightly yellowish, sub-round to round; trace pink silty well-cemented, soft; all with no fluorescence; sandstone, light orange white, very fine to fine, friable, soft, excellent visible porosity, no show, no fluorescence.
(Representative cuttings from Second Converse Sand were cut in C. Tet. in stoppered shell vial; resulting solution had no fluorescence, indicating no oil in cuttings).
- 1985-88 (Drills like sand but slower than above, suggesting less porous sand). (Poor sample, abundant cave). Trace sandstone, pinkish light gray, very fine, good sorting, porous, friable, no show, few tiny white spots like clay; traces sandstone, snow white with abundant clay cementation, no

- 1988-91 porosity, no show, non-calcareous, very fine to fine-plus, clear grains, round, friable. Trace fairly clean light gray sandstone, sugary very fine to fine-plus, excellent visible porosity, friable, no show.
- 1991 BASE OF SECOND CONVERSE SAND
- 1991-2006 Trace very anhydritic dolomite to dolomitic lime, grayish brown, slightly cherty, with tiny black spots of possible microfossils; trace light brown limestone, hard, brittle, dense; trace chalky limestone, light brown, mottled with light green shale, highly microfossiliferous with tiny round "bugs."
- 2006-18 Limestone, silty, chalky, grayish tan to tannish gray with small blackish spots, also tannish light gray to whitish chalkier with same black spots, slightly soft to hard and brittle where grayer (* good pre-Second Converse Sand marker bed).
- 2018-26 (Slower drilling, harder). (Poor sample, unusable, all cave).
- 2026-41 (Poor sample, cave). Traces very anhydritic dolomite, light to dark greenish brown, cryptocrystalline, intermingled with snow white anhydrite, microcrystalline; trace dark brown limestone, cherty, dense, with trace round microfossil fragment.
- 2041-46 Silty dolomite to limestone, tan, light tan, grayish tan denser, part lighter tan anhydritic denser; trace very dense limestone, cherty, tannish brown, highly microfossiliferous with cream "bugs" in brown limestone matrix, with encrusting waxy; trace chalky limestone, green shaly.
- 2046-59 Silty limestone, dolomitic, chalky, dark tan, light tan, cream, slightly soft where chalky to hard where dark tan.
- 2059-69 Anhydrite, white to tannish white, finely crystalline, denser dark gray.
- 2069-75 Abundant orange red dolomite (?) with anhydrite inclusions; top anhydrite, white to brown; trace brown limestone, slightly silty, hard, brittle; bottom faster drilling possibly sandstone with some porosity: loose sand grains, very fine to fine, clear.
- 2075-86 Anhydritic dolomite, greenish dark tan, dense, cryptocrystalline, slightly limy on fresh surface,

- hard, brittle, part siltier, greenish gray, slightly soft to soft.
Snow white anhydrite.
- 2086-89
- 2089 TENTATIVE THIRD CONVERSE SAND
- 2089-94 Abundant greenish white quartzite, also gray, grading into greenish white sandstone and white sandstone, very fine, excellent sorting, all very well-cemented, no visible porosity, very hard and tight where quartzitic to soft where greenish white silty to white silty; trace white sandstone, very fine to fine, anhydritic; all with no show; non-calcareous, anhydritic; less of shaly light red sandstone mottled with same white sandstone, few fine grains; all with no fluorescence.
- 2094 BASE OF THIRD CONVERSE SAND
- 2094-2115 Abundant anhydrite, snow white finely crystalline to denser tan to limited brown dolomitic; shale break, brick red; trace very shaly sand, light red with pale green spot, very silty, very soft, no show, no visible porosity, very fine sand grains in a silty shale matrix.
- 2115-25 Same brown and white anhydrite; shaly sandstone streaks as above, red and white mottled, very fine, hard, tight, no show, no visible porosity.
- 2125-54 Same white anhydrite with brown to gray denser parts.
- 2154 (+1388) FOURTH CONVERSE SAND
- 2154-65 Abundant well-cemented sand, 50% white, pinkish white, anhydritic-looking, very fine, excellent sorting, no visible porosity, no show, slightly soft to some hard; 50% same sand but light red to dark pink, no show; white more anhydritic spot in red sand; all possibly slightly dolomitic, no fluorescence; trace white sandstone, cleaner, very fine, soft, porous, no show.
- 2165 BASE OF FOURTH CONVERSE SAND
- 2165-66 Anhydrite, white, gray denser; silty limestone, pinkish tan, soft to hard, white anhydrite spot, few dark purple silty shale streaks; dense brown

- dolomite grading into chalky limestone, tannish cream.
- 2166-76 Traces limestone to dolomite, creamy white, slightly soft to hard; silty dolomite to limy dolomite, pinkish cream, purplish shaly streaks, soft to slightly soft, becoming anhydritic dolomite, reddish purple, dense, hard.
- 2176-89 (Missing).
- 2189-92 Very anhydritic dolomite, few small limy spots, pink to light red with few small red silty shale spots, very cherty and hard, brittle, semi-crystalline, trace clear crystalline anhydrite veinlet on dolomite.
- 2192-2201 Abundant brick red shale, silty shale, smooth, with small round green spots; anhydrite, white, denser pink, light red; cream dolomite to limy dolomite, becoming very anhydritic dolomite as above, pink, light red, few yellow spots.
- 2201-12 Abundant anhydrite, snow white, finely crystalline.
- 2212-24 Anhydritic dolomite, tannish pink, small reddish spots, cherty, hard, brittle.
- 2224-26 Anhydrite, white to denser gray; abundant brick red shale with small green round spots, soft; anhydritic dolomite, pink, cherty, to limestone, hard, brittle.
- 2226 **BASAL SAND OF CONVERSE**
- 2226-37 Traces sandstone, white, pinkish white, very fine, few fine grains, no show, well-cemented, soft, anhydritic to traces of dolomitic cementation, no fluorescence, poor or less visible porosity, purplish part.
- 2237 (+1305) **RED MARKER**
- 2237-47 (All faster drilling 3"-4"/ft.). Shale, smooth, brick red, also silty; trace white anhydrite veinlet in shale; small round green spots in red shale.
Typical shiny, splintery Red Marker, platy, very soft.
- 2247 **BASE OF RED MARKER**
- 2247 (+1295) **PENNSYLVANIAN**

2247 (+1295) MIDDLE MINNELUSA (LEO SECTION)

2247 (+1295) VIRGIL

2247-56 (Faster drilling from 2250 to 2256 like well-cemented sand). Trace light red sand (cave?), very fine to fine, no show, slightly soft, poor porosity, pinkish clear grains; remainder of interval anhydritic dolomite, cream chalky to hard tan dense, dolomite is slightly limy. Trace sand, brown possible staining, very fine, excellent sorting, friable, porous, very limy, no rainbows on acid, no fluorescence.

2256-66 (Dries like anhydrite and dolomite--poor sample).
2266-77 (Poor sample, mostly Red Marker cave; drills slow like anhydrite and dolomite). Traces very well-

cemented sand, purplish white, very fine, few fine grains, no show; trace snow white sandstone (cave?), very well-cemented, very fine, white clay cementation, slightly soft, no show; trace tannish gray possibly stained sandstone, very fine to fine to fine-plus, friable, porous, clear grains, clay cementation; all with no fluorescence. (All sand may be cave).

2277-79 Traces anhydritic dolomite, tan, cherty, hard, dark tan; traces sandstone, white, cream-white, very fine, silty, soft, no show, possibly porous, no fluorescence, few fine grains, anhydritic cementation.

2279-81 (Missing due to no circulation for sample at 2281 just before trip for bit in slow drilling).

2281-85 Silty dolomite, gray, very silty, limy, some black spots; sandstone streaks, white, light gray, very fine, well-cemented, few black shale spots, no show, no visible porosity, soft.

2285-90 (Slightly faster drilling like sand). Traces white sandstone, very fine, good sorting, well-cemented, poor to no visible porosity, no show, slightly salt and pepper with few blackish grains scattered, soft; trace cleaner white sandstone, less cemented, no show, porous, friable, very fine, excellent sorting; all with no fluorescence (shale break on log).

2290-93 Dolomite, part slightly limy, tan to brown, flaky, no show, no porosity.

2293-2302 (Slightly faster drilling). Trace chalky cream dolomite, slightly soft to soft, limy.

2310-16 Same dark tan dolomite as 2290 to 2293, limy.
2316-26 (Slightly faster drilling, like sand). Traces sandstone, white, very anhydritic-looking, abundant white cementation, silty, very fine, few fine grains, angular to subround, few purplish shaly spots, no show, soft; traces white sand, very fine, few fine grains, no show, silty, white, possibly some porosity.

2326-36 Same dark tan dolomite as 2290 to 2293.
(Very poor unusable sample, almost all cave, not screened). (All drills very slow like hard dolomite, possibly anhydrite also).

2336-47 Dolomite, anhydritic dolomite, brown where more anhydrite, also dark gray dense to dark gray siltier.
(Very poor sample, almost all cave). (All drills slow like dolomite above). Traces white sandstone, probably in streaks, light gray, no show, well-cemented, very fine; part less cemented very fine to fine friable with porosity (cave?).

2347-51 (Circulated 20" sample at 2351 before trip for bit). Anhydrite, white to tan, finely crystalline, grading into dark tan dolomite and limy dolomite.

2351-53 Same as above.

2353 (+1189) MISSOURI

2353-54 (Highly radioactive shale on log).

2354 (+1188) SECOND LEO SAND

2354-57 Loose sand grains, very fine, clear, also fine; trace clean sandstone, light gray, very fine, good visible porosity, friable, no show.

2357-60 (Drills 4" to 5"/ft.). Traces well-cemented sand, very fine, no show, poor visible porosity, soft, light gray, white, slightly silty, no fluorescence; loose sand grains, very fine, fine, clear grains, round to subround.

2360-64 (Circulated 20" sample at 2365). Limited sandstone, white, light gray, well-cemented, shaly, very fine, no show; part less cemented with some porosity, friable, no show; 2% light brown possibly stained, cleaner less cemented, very fine, soft, porous; all with no fluorescence (5⁺"/ft.).

2364-65 (Circulated 30" sample at 2365). Same well-cemented sand, very fine, no show, few fine grains, anhy-

dritic-looking cementation; trace same cleaner sand, very fine, very light brownish possibly stained, porous, friable.

* All above sand from 2354 to 2365 has no hydrocarbon cut nor fluorescence after cutting representative cuttings in C. Tet. in stoppered shell vial.

2365-66

Traces clean sandstone (probably above 2365), friable, excellent visible porosity, no show, light gray, so soft disintegrates when picked up with tweezers; trace friable white sandstone, abundant white cementation like clay, very fine to abundant fine, porous, clear grains, no show, loosely consolidated, non-calcareous; trace same well-cemented sand, very fine sand as above; all with no fluorescence; trace white sandstone, very fine, excellent sorting, well-cemented, no show, soft; trace light tan possibly stained sandstone, fine to very fine, limy, porous, friable.

2366-73

Dolomite stringer, grayish dark tan; greenish gray anhydritic dolomite to dolomitic lime; trace sandstone, light tan possibly stained, no live oil on freshly broken surface, friable, excellent visible porosity, salt and pepper with scattered dark gray shale grains, clear to slightly frosted grains, non-calcareous.

2373-75

(Circulated 20" sample at 2378). 75% jet black shale, coaly, strong hydrocarbon odor.

2375-78

25% gray chalky dolomite.

* Representative sand cuttings from 2354 to 2373 were cut in C. Tet. with no fluorescence in resulting solution, indicating no live oil in cuttings.

2378-82

(Top 2' are 2"/ft., bottom 2' are 1"/ft.). Abundant sandstone, light to medium tan oil staining when wet, dries to fair or better tan stain, definite abundant tiny brown live oil spots scattered, 80% fair yellowish fluorescence to 20% with good bright yellow fluorescence, anhydritic to dolomitic cementation, silty, very fine, good visible porosity, friable.

2382-93

(Circulated 20" sample at 2393). Abundant sandstone, light gray with tannish cast plus tiny dark brown live oil spots scattered, limy cementation, very fine to fine more sugary, friable, excellent visible porosity, acid cuts immediate rainbows, clear subround quartz grains; sandstone soaked with tan oil stain in very fine, cemented sand-

stone, some spotty white cementation like clay, tiny dark brown live oil stains scattered, acid brings out tiny dark brown oil bubbles, fair or better visible porosity, soft to slightly soft. * Representative cuttings of show zone were cut in C. Tet. in cork stoppered shell vial: there was no fluorescence in solution until several hours later when it was a faint grayish to yellowish.

2393-96 (Sand on log).

2396 BASE OF SECOND LEO SANDS

2396-2404 Chalky limy dolomite to dolomitic lime, cream-tan, denser tan also, few grayish streaks; limited associated anhydrite, finely crystalline white.

2404-15 Slightly silty dolomite, very finely sandy, grayish dark tan, minute pyrite specks.

2415-17 Coaly black shale, hard, brittle (probably a radioactive shale marker on log).

2416 DES MOINES (?)

2417-26 Abundant red shale in fast drilling breaks, orange red, silty to finely sandy, abundant small round light green spots in shale, with few anhydrite inclusions; remainder anhydritic dolomite, gray, few small limy streaks, part dark gray very shaly with few dark green spots; limited very sandy dolomite, limy, gray, flaky; limited sand streaks, gray, very well-cemented, no show, no porosity, hard, tight, very fine to fine; trace white sandstone, lot cleaner, very fine to fine, well-cemented, no show, possibly porous, soft (cave?).

2426-29 (Fast drilling shale break at 2429 to 2430). Same anhydritic dolomite, light grayish tan with dark gray shaly spots, minute pyrite specks, also dark tan with blackish spots, trace gray very sandy.

2429-30 Possibly jet black coaly shale (highly radioactive shale on log).

2430-35 Same as from 2426 to 2429.

2435-46 Shale break from 2440 to 2441, orange red smooth plain to silty; same anhydritic dolomite, gray to tan, less of silty limy dolomite, light gray, chalky; few sandstone streaks, grayish brown, slightly quartzitic-looking, very fine, very well-cemented, no show, poor to no visible poros-



- ity, part slightly soft; trace gray sandstone, very shaly and well-cemented, no show, no visible porosity, very fine to fine.
- 2446-53 Dolomite, limy dolomite, grayish tan to tan, cryptocrystalline, some associated white anhydrite, hard, brittle, few pyrite specks.
- 2453-55 Faster drilling plus shale on log.
- 2455-56 Sandstone stringer, white, fine, no show, very well-cemented, no visible porosity, same but shalier tannish gray, soft where white.
- 2456-59 Abundant sandstone, (possibly Third Leo Sand), snow white, very fine, fine, good sorting, no show, porous, anhydritic-looking, dolomitic to anhydritic cementation, part hard and tight, grayish yellow to yellow fluorescence, probably from dolomitic cementation, soft, part all fine grained.
- 2459-73 No odor in fresh sackfull, same sandstone as above; part softer, cleaner, more porous, trace more porous with slight tannish possible staining, same fair or better fluorescence; trace fine sandstone, sugary, friable, excellent visible porosity; becoming gray slightly quartzitic, poorly sorted fine to few medium grains, hard, tight.
- 2473-85 Abundant anhydrite, snow white, grayish where denser; abundant red shale, orange red, plain, silty, soft to slightly soft, few small light gray round spots.
- 2485-91 (Missing due to no circulation for sample before trip at 2491).
- 2491-2501 Mostly shaly dolomite, gray, dark gray, tannish dark gray, part limy, with abundant associated snow white anhydrite, finely crystalline; thin sand beds, white, light gray, fine, fairly clean, good visible porosity, no show, slightly soft, some black carbonaceous streaks; also dark gray shaly sand, soft, fine, porous to nonporous, black carbonaceous streaks; all with no fluorescence.
- 2501-10 Faster drilling sand, traces sand, white, very well-cemented, no show, very fine, no visible porosity to limited porosity, soft to slightly soft, possible faint grayish fluorescence.
- 2510-14 Limy dolomite to dolomitic lime, tannish brown, silty, blackish spots in part, also light gray; tan dense dolomitic lime to limy dolomite, hard, brittle.



- 2514-18 (Missing due to no circulation for sample just before trip at 2518).
- 2518-26 * First chert, trace, smoky gray translucent, very coarse and angular, also light brown translucent; sandstone, white, light gray, very well-cemented, poor visible porosity, very fine, well-sorted, slightly soft, part light gray less cemented; part white hard and tight; all limy, all with no show; limy dolomite, very light tan, cherty, hard, brittle, also dark tan limy dolomite, cryptocrystalline; white anhydrite; sand in top 7'.
- 2526-31 Brick red shale break with few small round light green spots; dolomite, sandy dolomite, gray, dark gray, mottled blackish in part, part limy dolomite; same chert; sandstone streaks, shaly, quartzitic, light gray to gray, very well-cemented, no show, no visible porosity, slightly soft.
- 2531-38 Chert, tan, milky white, angular, coarse; same quartzitic sandstone streaks, brownish gray; finely sandy limy dolomite to dolomitic lime, tannish brown.
- 2538-43 (Circulated 30" sample at 2543 T. D.). Chert, angular, very coarse, tan to light gray milky; limy dolomite to limestone, tannish brown, dense plain to cryptocrystalline; sandstone, white, very fine, very well-cemented, no show, no visible porosity, light gray, tannish light gray tighter, slightly limy, becoming brown quartzitic, good yellow fluorescence from limy mineralization.

- 2545 TOTAL DEPTH DRILLER

- 2544 TOTAL DEPTH SCHLUMBERGER

Samples examined and described on location by G. Allan Nelson.

DRILL-STEM TEST

D.S.T. #1 2379-2393 P. D. * (Corrected uphole 2' by matching lithology and drilling time to log).
(2381-2395 drillers depths at time test was run).
Zone tested: Lower of 2 Second Leo Sand benches.
November 25, 1970. Open hole conventional test.
Top packer at 2371 corrected.
Bottom packer at 2379 corrected.
Top choke 1". Bottom choke 9/16".
Hole size 7 7/8". 3 1/2" drill pipe.
2 1/4" I.D. of drill collars; 542' of drill collars.
Mud wt. 9.5. Vis. 60.
Packers held and did not leak. No cushion.

Tool opened with a very weak blow and remained open 5"; very weak blow throughout period. Tool reopened with a very weak blow (1/4" under water); remained for 10", then intermittent blow throughout rest of test. (By-passed tool after 50" to see if it was plugged--before opening. Well had 3" to 4" water flow from annulus throughout test--from Dakota-Lakota. 3' fillup on bottom).

Recovered: 60' gas-cut mud with a sulfur smell=.29 bbl.
80' water with scum of oil and sulfur smelling gas=.39 bbl.
140' Total Fluid

Pressures following are office-corrected:
Initial hydrostatic - 1102
Final hydrostatic - 1100
5" Initial flow - 4 to 21
45" Final flow - 31 to 76
15" Initial shut-in - 969
15" Final shut-in - 914

Fluid Sample Report:
Pressure in sampler - 11 psig
BHT - 96° F.
Total volume of sampler - 2150 cc.
Sample - 2150 cc.
Oil - 10 cc.
Water - 2140 cc.
(No mud or gas)



DRILL-STEM TEST (Continued)

Resistivity -

Water - .4 @ 62° = 17,200 ppm chlorides

Mud pit sample - 2.6 @ 60° = 2,550 ppm
chlorides

Testing done by Virg's Testers, Gillette, Wyoming.
Tester: Lloyd Welty.

Checked periodically during test for combustability;
would not burn. No gas to surface.



SCHLUMBERGER LOG CALCULATIONS

Calculations were performed by Mike Golas, Schlumberger engineer on location.

<u>DEPTH</u>	<u>Rt</u>	<u>POROSITY (from Sonic)</u>	<u>Rw</u>	<u>Sw</u>	<u>FORMATION</u>
1062	29	22%	1.6 @ 80°	100%	Tentative Hulett Sand
1074	33	23	"	"	"
1078	31	23	"	"	"
1866	50	18	1.3 @ 88°	78%	First Converse Sand
1871	45	17	"	90	"
1878	55	16	"	"	"
1885	40	18	"	"	"
1966	45	15	"	100%	Second Converse Sand
1970	35	17	"	"	"
1980	35	17	"	"	"
2376	35	6	.34 @ 88°	"	Second Leo Sand
2378	26	25	("way too high")	42	"
2380	35	10	.34 @ 88°	92	"
2382	42	5	"	100	"
2384	30	6	"	"	"
2386	21	6	"	"	"
2388	25	9	"	"	"
2458	6.5	11	"	"	Pre-Second Leo
2460	5.5	14	"	"	"
2462	6.5	8	"	"	"
2464	6.0	7	"	"	"
2466	5.0	15	"	"	"
2468	6.5	10	"	"	"

HOLE DEVIATION SURVEYS

Surveys were made using a TOTCO instrument with a 7° maximum.

<u>DEPTH</u>	<u>DEVIATION</u>	<u>FORMATION</u>
178	1/4°	Skull Creek
1086	1	Tentative Hulett Sand
1691	1	Glendo Shale
1939	1	Massive Anhydrite
2188	1	Pre-Fourth Converse
2282	1 (?)	Upper Leo
2352	1	Basal Virgil

BIT RECORD

12 1/4" bit from surface to 178. All bits below 178 are 7 7/8".

<u>RUN NO.</u>	<u>MAKE</u>	<u>TYPE</u>	<u>FROM</u>	<u>TO</u>	<u>FEET</u>	<u>HOURS</u>	<u>FORMATION AT BASE OF RUN</u>
1A	HTC	OSC3 (RR)	0	178	178	5 1/2	Skull Creek
1	"	OSC1GJ	178	1086	908	18	Tentative Hulett
2	"	"	1086	1707	621	14	Minnekahta
3	"	OSC1G	1707	1939	232	11 1/4	Massive Anhydrite
4	Reed	YS1G	1939	2091	152	12 1/2	Third Converse
5	-	-	2091	2189	98	13 1/4	Pre-Fourth Converse
6	HTC	OWV	2189	2282	93	"	Upper Leo
7	Reed	YMG	2282	2352	70	13	Basal Virgil
8	"	"	2352	2395	43	5 1/2	Second Leo Sand
9	-	-	2395	2493	98	14	Pre-Second Leo
10	-	-	2493	2520	27	3	"
11	-	-	2520	2545 T.D.	25	3 1/4	"

DRILLING PROGRESS SUMMARY

Drilling depths as of 7 A. M. each date.

<u>DATE</u>	<u>NO. OF DAYS</u>	<u>P.D. DEPTH</u>	<u>FORMATION AT P. D.</u>	<u>STATUS</u>
Nov. 17, 1970	-	-	-	Rigging up rotary tools.
18	1/2	105	Skull Creek	Drilling surface hole.
19	1 1/2	821	Morrison	Drilling.
20	2 1/2	1681	Goose Egg	"
21	3 1/2	2040	Upper Minnelusa	"
22	4 1/2	2189	"	Trip for bit.
23	5 1/2	2284	Middle Minnelusa	Drilling.
24	6 1/2	2374	"	"
25	7 1/2	2395	"	Starting out to put tool on -- D.S.T. #1.
26	8 1/2	2493	"	Trip for bit.
27	9 1/2	2545 T.D.	"	Logging.

(Finished plugging at 5:00 P. M., November 27).

Respectfully submitted,

G. Allan Nelson, Consultant
 Denver, Colorado
 January 26, 1971



Hydro ID 3

STATE: South Dakota
 COUNTY: Fall River
 T. 22 S. R. 1E
 SEC. 22
 75. 1E
 2544 Schlum.
 Schlei Klev
 Nov. 18, 1970
 Nov. 27, 1970
 Wildest - Drift
 3542 K.B. wind Canyon
 D.A. Prospect.
 Petro-Lewis #5-22
 1620' FEL & 1980'
 Run 4 jts. of 5" sfc
 casing, total 1620', 8 rd, 20"
 Casing 1620' x 1 1/2" outside
 casing 1620' x 1 1/2" inside
 1620' out 1620' x 1 1/2"

1441	Petro-Lewis #5-22
1500	1500
1570	1570
1600	1600
1634	1634
1618	1618
1752	1752
1739	1739
1800	1800
1815	1815
1727	1727
1838	1838
1709	1709
1500	1500
1911	1911
1942	1942
1961	1961
1981	1981
2000	2000
2094	2094
2154	2154
2130	2130
2200	2200
2226	2226
2237	2237
2248	2248
2360	2360
2353	2353
2367	2367
2376	2376
2500	2500
2515	2515

*Sols examined & described
 by G. Allen Nelson, Consult.
 2nd Denver

Anhydrite 35 of 60
 Pyrite
 Fossils
 Chert
 Pebbles
 Muddy Sand (Newcastle)
 (behind stc pipe)
 Skull Creek Shale
 (behind stc pipe)

ALL PLOTTED LITHOLOGY
 BELOW CORRECTED TO
 MATCH LOGS

724 73218	Dakota Fm. (Fall River Fm) shly siltst. 17 gy. w/ blsh lumps; ss, fn, sl, sgy, vis. porsty. Abnt. shly siltst. dk. gy. siltst. med. part. sand. siltst. cl. siltst. Sand. dk. gy. shly siltst. 8 ft. 11 gy. ss. s. b. w/ gy. porsty, slt. wh. clay sps. Hd. wxy clay, tanish gy. gy.
452 469 73073	Fuson Shale (Eusan Mem) top of Lakota Fm) L. shly siltst. Abnt. shly w/ ss. wily (red) w/ abnt. w/ wxy clay. tan. s. b. med. loose sd. gy. siltst. w/ abnt. wxy clay. w/ wxy thin ss. of fuson. (s. b. med. siltst. med. pyrite) med. clay. (Cave) Same. gash. dk. sh. sl. wxy the char. clay. med. w. clay. med. shly. siltst. w/ med. Abnt. pebbles. med. clay. siltst. (see cone 3) loose pyrite. (Cave) Loose. med. clay. v. med. to pebbly. siltst. loose. siltst. w/ med. clay. siltst.
700 72842	Morrison Fm. Abnt. pale. gy. wxy. clay. w/ siltst. tan. luma. (siltst.)
832 72710	Sundance Fm. (Redwater) Spalla Mambak (Massy sps.) shly. siltst. dk. gy. v. shly. sd. med. part. siltst. v. med. wxy. shly. siltst. v. med. siltst. med. part. siltst. v. med. siltst. med. part. siltst. v. med. siltst. med. part. siltst. v. med.
966	LAK Mambak of Sundance Some. sd., med. part. siltst. v. med. dk. wxy. shly. v. siltst.
1061	Mambak Hillside Sand Thin. dk. gy. sd. v. med. part. s. b. siltst. shly. gy. siltst. med. part. siltst.
1092	Base of Sand-Top of Mambak Stockade Beaver Shale
1111 72360	Same. sh. med. part. siltst. siltst.

ADMINISTRATIVE / SUNDRY REPORTS



PLUGGING RECORD

Operator: **Petro-Lewis Corporation** Address: **1224 Denver Club Building, Denver, Colorado, 80202**

Name of Lease: **Peterson** Well No.: **5-22** Field & Reservoir: **Wildcat**

Location of Well: **1980' FNL and 660' FWL SW-NW Section 22, T7S, R1E** Sec/Top-Rge or Block & Survey: _____ County: **Fall River**

Applicant to drill this well was also in name of: **Petro-Lewis Corporation** Has this well ever produced oil or gas: **No** Character of well at completion (initial production): Oil (bbls/day): _____ Gas (MCF/day): _____ Dry? **Yes**

Date plugged: **11/27/70** Total depth: **2544' Logger** Amount well producing when plugged: Oil (bbls/day): _____ Gas (MCF/day): _____ Water (bbls/day): _____

Name of each formation containing oil or gas. Indicate which formation open to well-bore at time of plugging	Fluid content of each formation	Depth interval of each formation	Size, kind & depth of plugs used indicate layers squeeze cemented, giving amount cement.

CASING RECORD

Size pipe	Put in well (ft.)	Pulled out (ft.)	Left in well (ft.)	Give depth and method of parting casing (shot, ripped, etc.)	Packers and spacers
8-5/8"	167'	None	167'		

Was well filled with mud-faden fluid, according to regulations? _____ Indicate deepest formation containing fresh water. _____

In addition to other information required on this form, if this well was plugged back for use as a fresh water well, give all pertinent details of plugging operations to base of fresh water sand, perforated interval to fresh water sand, name and address of surface owner, and attach letter from surface owner authorizing completion of this well as a water well and agreeing to assume full liability for any subsequent plugging which might be required.

USE REVERSE SIDE FOR ADDITIONAL DETAIL

Executed this the 15th day of February, 1971
State of Colorado
County of DENVER
Signature of Affiant: R. J. Dzubek
Notary: R. J. Dzubek

Before me, the undersigned authority, on this day personally appeared R. J. Dzubek known to me to be the person whose name is subscribed to the above instrument, who being by me duly sworn on oath states, that he is duly authorized to make the above report and that he has knowledge of the facts stated therein, and that said report is true and correct.

Subscribed and sworn to before me this 15th day of February, 1971.
SEAL
My commission expires September 29, 1974
Notary Public in and for Colorado
County, Colorado

DO NOT WRITE BELOW THIS LINE
Approved: December 29, 1971
Date
OIL AND GAS BOARD OF THE STATE OF SOUTH DAKOTA
Alma Larson Secretary

Dec 28, 1971
Dorothy Williams
State Geologist
Note: File 2 copies of this form with Secretary, Oil & Gas Board, Pierre.

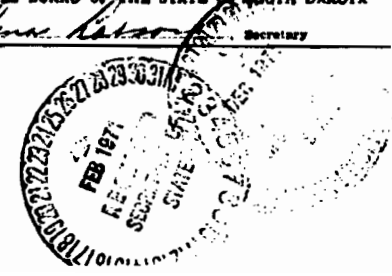

S. Dak. Oil & Gas Board
FORM 4

WELL COMPLETION OR RECOMPLETION REPORT AND LOG				FARM OR LEASE NAME <u>Peterson</u>	
TYPE OF COMPLETION <input type="checkbox"/> Oil Well <input type="checkbox"/> Gas Well <input type="checkbox"/> Dry Hole <input type="checkbox"/> New Well <input type="checkbox"/> Work-Over <input type="checkbox"/> Deepen <input type="checkbox"/> Plug Back <input type="checkbox"/> Same Zone <input type="checkbox"/> Diff Zone				WELL NO. <u>5-22</u>	
OPERATOR <u>Petro-Lewis Corporation</u>				FIELD AND POOL, OR WILDCAT <u>Wildcat</u>	
ADDRESS <u>1224 Denver Club Building, Denver, Colorado, 80202</u>				NO. ACRES IN LEASE	
LOCATION (In feet from nearest lines of section or legal subdivision where possible) Surface <u>1980' FNL and 660' FML, SW-NW, Section 22, T7S, R1E</u> Top prod. interval <u>Fall River County, South Dakota</u> At total depth				1/4 SEC. TWP. ROE. <u>SW-NW Section 22, T7S, R1E</u> COUNTY <u>Fall River</u>	
PERMIT NO. <u>606</u>	DATE ISSUED <u>10/21/70</u>	PREVIOUS PERMIT NO. ----	DATE ISSUED -----		
DATE SPOUDED <u>11/17/70</u>	DATE T. D. REACHED <u>11/27/70</u>	DATE COMPL. (Ready to Prod.) <u>P&A 11/27/70</u>	ELEVATIONS (DP, RKB, RT, CR, etc.) <u>Gr. Elev. 3534'</u>	ELEV. CASINGHEAD FLGE. -----	
TOTAL DEPTH (MD & TVD) <u>2544' Logger</u>	PLUG BACK T. D. (MD & TVD) -----	IF MULTIPLE COMPL. HOW MANY* -----	INTERVALS DRILLED BY -----	ROTARY TOOLS <u>XXXX</u>	CABLE TOOLS -----
PRODUCING INTERVAL(S), THIS COMPLETION, TOP, BOTTOM, NAME (MD & TVD)* <u>Dry Hole</u>				DATE DIRECTIONAL SURVEY SUBMITTED <u>None</u>	
TYPE ELECTRIC AND OTHER LOGS RUN (Circle those filed) <u>Dual Induction Laterolog, Compensated Borehole Sonic - Gamma Ray</u>				WAS WELL CORED <u>No</u>	
CASING RECORD (Report all strings set in well)					
CASING SIZE <u>8-5/8"</u>	DEPTH SET (MD) <u>167' KB</u>	HOLE SIZE <u>12-1/4"</u>	WEIGHT LBS./FT. <u>20#</u>	PURPOSE <u>Surface casing</u>	AMOUNT PULLED <u>100 sx. None</u>
LINER RECORD			TUBING RECORD		
SIZE	TOP (MD)	BOTTOM (MD)	SACKS CEMENT*	SCREEN (MD)	SIZE
None			None		
PERFORATION RECORD ACID, SHOT, FRAC, CEMENT SQUEEZE, Etc.					
DEPTH INTERVAL (MD)	HOLES PER FT.	SIZE AND TYPE	PURPOSE	AMOUNT AND KIND OF MATERIAL USED	DEPTH INTERVAL (MD)
None					None
PRODUCTION					
DATE FIRST PRODUCTION <u>Dry Hole</u>	PRODUCING METHOD (Flowing, gas lift, pumping, etc. & type of pump)	WELL STATUS (Prod. or shut-in) <u>P&A 11/27/70</u>			
DATE OF TEST	HOURS TESTED	CHOKED DEEP PRODUCTION FOR TEST	OIL, Sls.	GAS, Mcf.	WATER, Bbls. & %
FLOW, TUBING PRESSURE, CASING PRESSURE		CALCULATED 24-HOUR RATE	OIL, Sls.	GAS, Mcf.	WATER, Bbls. & %
DISPOSITION OF GAS (Sold, used for fuel, vented, etc.)				TEST WITNESSED BY	

LIST OF ATTACHMENTS

I hereby certify that the foregoing and attached information is complete and correct as determined from all available records

R. J. Doubek TITLE Manager of Operations DATE 2/15/71

DO NOT WRITE BELOW THIS LINE

Approved: _____ Date: _____ OIL AND GAS BOARD OF THE STATE OF SOUTH DAKOTA Secretary





DATE FOR LOG... FORM 6

SUNDRY NOTICES AND REPORT ON WELLS		FARM OR LEASE NAME Peterson
		WELL NO. 5-22
<input type="checkbox"/> OIL WELL <input type="checkbox"/> GAS WELL <input type="checkbox"/> ----- <input checked="" type="checkbox"/> DRY		FIELD AND POOL, OR WELDCAT Wildcat
OPERATOR Petro-Lewis Corporation		NO. ACRES IN LEASE
ADDRESS 1224 Denver Club Building, Denver, Colorado, 80202		N. & E.C. TWP. R. 10E
LOCATION (IN BOX FROM SECTION 16 OR 16A OF REG. SURVEY, WHERE POSSIBLE) 1980' FNL and 660' FWL, SW-NW Section 22, T7S, R1E		SW-NW Section 22, T7S, R1E
ELEVATIONS (H.T., H.C., R.T., G.S., OR: LOW SURVEYING) Gr. Elev. 3534'		COUNTY Fall River

INDICATE BELOW BY CHECK MARK NATURE OF REPORT, NOTICE OR OTHER DATA

NOTICE OF INTENTION TO:		SUBSEQUENT REPORT OF:	
TEST WATER SHUT-OFF	<input type="checkbox"/>	SHOOT OR ACIDISE	<input type="checkbox"/>
FRACTURE TREAT	<input type="checkbox"/>	WATER SHUT-OFF	<input type="checkbox"/>
MULTIPLE COMPLETE	<input type="checkbox"/>	FRACTURE TREATMENT	<input type="checkbox"/>
ABANDON	<input checked="" type="checkbox"/>	SHOOTING OR ACIDIZING	<input type="checkbox"/>
		REPAIRING WELL	<input type="checkbox"/>
		ALTERING CASING	<input type="checkbox"/>

(Note: Report results of multiple completion on Well Completion or Accomplishing and Log Form - Form 4)

DESCRIBE PROPOSED OR COMPLETED OPERATIONS (Clearly state all pertinent details, and give pertinent dates, including estimated date of starting any proposed work)

T. D. 2544' Logger
Date of Work 11/27/70

We propose to plug and abandon this well as follows:

- 40 sx. cement from 2300'-2420'
- 30 sx. cement from 1750'-1850'
- 30 sx. cement from 1030'-1130'

(Contractor will run pipe to complete as water well for landowner. Pipe will be set at 350'. (Dakota).)

I hereby certify that the foregoing as to any work or operation performed is a true and correct report of such work or operation.
SIGNED R. J. Doubek TITLE Manager of Operations DATE 2/15/71
R. J. Doubek

Approved _____ DO NOT WRITE BELOW THIS LINE
SECRETARY OF OIL AND GAS BOARD OF THE STATE OF SOUTH DAKOTA
CONDITIONS, IF ANY: _____ Secretary

See Instructions On Reverse Side



CORRESPONDENCE



AMERICAN STRATIGRAPHIC COMPANY

17 NORTH 21ST STREET • BILLINGS, MONTANA 59101 • PHONE 298-7647

November 18, 1971

NOV 22 1971

South Dakota Geological Survey
Attn: Dr. Duncan McGregor
Science Center, University
Vermillion, South Dakota 57069

Gentlemen:

Sample cuts on the following wells are being sent
to you today:

Petro-Lewis Corp. #14-14 Childers
14-8S-2E, Fall River Co., S. D.

Petro-Lewis Corp. #5-22 Peterson
22-7S-1E, Fall River Co., S. D.

Petro-Lewis Corp. #3-7 Trotter-Federal
7-9S-2E, Fall River Co., S. D.

Very truly yours,

Fred McCotter
Manager



SOUTH DAKOTA GEOLOGICAL SURVEY

Science Center, University
Vermillion, South Dakota 57069
624-4471

Western Field Office
615 Birch Ave.
Rapid City, South Dakota 57701

JUN 24 1971

(605)394-2229

June 23, 1971

Dr. Duncan J. McGregor
State Geologist
South Dakota Geological Survey
Science Center USD
Vermillion, South Dakota 57069

Dear Dunc,

On June 21, 1971 we inspected the sites of the following oil tests and find that they have been satisfactorily restored. The wells are as follows:

Permit

- 606 Petro-Lewis #5-22 Peterson, SWNW 22-17N-1E, Fall River County
- 614 Petro-Lewis #14-14 Childers, SESW 14-8S-2E, Fall River County
- 631 Webb Resources #11-16 Zuehlke, SENE 11-11-4E, Fall River County

As soon as all other requirements have been met I recommend the release of bond.

Sincerely

Fred V. Steece
Principal Geologist

FVS/dme
cc: Petro-Lewis Corporation

Webb Resources, Inc.

January 13, 1971

Mr. Fred V. Steece
Western Field Office
615 Birch Ave.
Rapid City, South Dakota

Dear Fred:

I am enclosing the following logs:

- 1 Sonic log - Gamma ray and 1 Dual Induction-Laterolog for Petro-Lewis 5-22 Peterson well, Fall River County
- 1 Induction-Electrical log and 1 Sonic log - Gamma ray for Lee Banks #1-23 Federal-Richards in Butte, County
- 1 Microlaterolog and 1 Sonic log - Gamma ray for Consolidated #1 Tribal well in Corson County
- 1 Induction-electrical log for Consolidated #1 Tribal well in Corson County.

Sincerely,

(Mrs.) Ruth Lynch
Accounting Clerk

For the State Geologist

Encl.

Small log



DEC 16 1970

Western Field Office
615 Birch Avenue
Rapid City, South Dakota 57701

((605)394-2229

December 15, 1970

Mrs. M. Lenore Peterson
Star Route
Edgemont, South Dakota

Dear Mrs. Peterson,

Thank you for your letter of December 11, 1970 regarding the Webb Resources #5-22 Peterson oil test, located on your land in SW 1/4 N. 1/4 Sec. 22, T. 7S., R. 1E., Fall River county, South Dakota. The letter is fine as far as it goes, however it is incomplete.

I have enclosed the original and three carbon copies of a suggested substitution to your letter. If you approve of this please date and sign the original and two carbon copies and send them to:

South Dakota Oil and Gas Board, Capitol Office Building, Pierre,
South Dakota 57501

Mr. J. W. Grimes, Chief Engineer, South Dakota Water Resources Comm.,
Capitol Office Building, Pierre, South Dakota 57051

Fred V. Steece, Principal Geologist, Geological Survey, Western
Field Office, 615 Birch Avenue, Rapid City, South Dakota 57701

The other copy is for your files.

Sincerely

Fred V. Steece
Principal Geologist

FVS/dms
cc: Dr. Duncan J. McGregor
State Geologist



DEC 15 1970

Western Field Office
615 Birch Avenue
Rapid City, South Dakota 57701

(605) 394-2229

December 14, 1970

Mr. J. W. Grimes
Chief Engineer
South Dakota Water Resource Comm.
Capitol Office Building
Pierre, South Dakota 57501

Dear Joe,

Friday, December 11, 1970, I spoke with Don Driscoll on the telephone with regard to an oil test in Fall River county that has recently been converted to a water well. The well is the Petro-Leads #5-22 Peterman located in S44W 22-7S-1E Fall River (permit 608). The well was drilled from November 18 to November 27, 1970 and completed as a water well in the Fall River Formation on November 28, 1970. The well has 167 feet of 8 5/8 surface casing cemented from top to bottom and was completed with 389 feet of 4 1/2 inch casing suspended inside the larger casing. The original depth of the well was 2545 feet and was plugged back to 1030, which plugs through the Basal Sundance sand and allows the well to take advantage of the maxium sand development of the Fall River and Lakota. The plugging record is as follows:

40 sec--2410-2300 across the Leo sand
30 sec--1850-1750 across the Converse sand
30 sec--1130-1030 across the Basal Sundance sand

If there is further information you need on this well, please let us know.

Sincerely

Fred V. Steece
Principal Geologist

cc: ~~Miss~~ Duncan J. McGregor
State Geologist

Miss Alma Larson
Secretary, Oil and Gas Board



SURETY

Hydro ID 3

67 of 69

State Pub. Co., Pierre

S. Dak. Oil & Gas Board
FORM 3

BOND NO. 1672873

BOND

KNOW ALL MEN BY THESE PRESENTS,

That
we: PETRO-LEWIS CORPORATION, 1224 Denver Club Building, Denver, Colorado 80202
of the _____ in the _____
County of: Denver State of: Colorado
as Principal,
and THE TRAVELERS INDEMNITY COMPANY
of Hartford, Connecticut

as surety, authorized to do business in the State of South Dakota as surety, are held and firmly bound unto the State of South Dakota in the sum of ~~THIRTY~~ TWENTY (\$20,000.00), lawful money of the United States, for which payment, well and truly to be made, we bind ourselves, and each of us, and each of our heirs, executors, administrators or successors, and assigns jointly and severally, firmly by these presents.

The condition of this obligation is that whereas the above bounden principal proposes to drill a well or wells for oil, gas, or stratigraphic purposes in and upon the following described land situated within the State, to wit:

ANY AND ALL LOCATIONS WITHIN THE STATE OF SOUTH DAKOTA

(May be used as Market bond or for single well)

NOW, THEREFORE, if the above bounden principal shall comply with all of the provisions of the laws of this State and the rules, regulations and orders of the Oil and Gas Board of the State, especially with reference to the proper plugging of said well or wells, and filing with the Oil and Gas Board of this State all notices and records required by said Board, and the restoration of the surface, in the event said well or wells do not produce oil or gas in commercial quantities, or cease to produce oil or gas in commercial quantities, then this obligation shall be terminated by the Board, the same shall be and remain in full force and effect.

Penal sum of

TWENTY THOUSAND AND NO/100 (\$20,000.00) DOLLARS-

Witness our hands and seals, this _____ day of _____

PETRO-LEWIS CORPORATION

By: D. A. Frawley
Principal

Witness our hands and seals, this 17th day of July, 1970

 **g. a. Talbert, Inc.**
SURETY BONDS AND INSURANCE
TWELVE HUNDRED LINCOLN STREET
DENVER, COLORADO 80202
AREA CODE 303 / 792-1230

THE TRAVELERS INDEMNITY COMPANY
By: G. A. Talbert
G. A. Talbert, Attorney-in-Fact

(If the principal is a corporation, the bond should be executed by its duly authorized officers, with the seal of the corporation affixed. When principal or surety executes this bond by agent, power of attorney or other evidence of authority must accompany the bond.)

DO NOT WRITE BELOW THIS LINE

OIL AND GAS BOARD OF THE STATE OF SOUTH DAKOTA

Approved October 21, 1970
Date

W. H. ...
Secretary

Countersigned in South Dakota
By: Francis F. Schmid
Agent at Rapid City, South Dakota 57701

3011
...

Note: File 3 copies of this form with Secretary, Oil & Gas Board, Pierre.

MISCELLANEOUS

**NO MISCELLANEOUS
INFORMATION FOR THIS WELL
AS OF 5/18/2011**



Oil and Gas Search for: api_no_ like '40 047 05093'		
Page 1 of 1	<u>Download Database</u> (Excel spreadsheet format)	Page: 1

Record 1 of 1

Well Information

API No:	40 047 05093	County:	FALL RIVER
Well Name:	SUPERIOR OIL 1 PETERSON 44-15	Location:	SESE 15-7S-1E
Permit No:	382	Total Depth:	2264
Operator Name:	SUPERIOR OIL COMPANY	Bottom Hole:	Minnelusa
Permit Date:	02-18-1965	KB Elevation:	3585
Spud Date:	02-20-1965	Ground Elevation:	3576
Plug Date:	03-05-1965	Latitude:	43.436899
		Longitude:	-103.977905
Well Field	WILDCAT	Status	P&A
Class:	DRY HOLE	Type:	DRY HOLE

Formation Tops

<u>Formation</u>	<u>Depth (ft.)</u>
Dakota Mud	185
Lakota	371
Morrison	471
Sundance	670
Minnekahta	1518
Opeche	1557
Minnelusa	1645
Red River	2108

Page 1 of 1 (goto top)	Page: 1
-------------------------------	----------------

COUNTY: FALL RIVER
LEGAL LOCATION: SESE 15-7N-1E
API NO: 40 047 05093
PERMIT NO: 382
WELL NAME: SUPERIOR OIL #1
PETERSON (44-15)
OPERATOR: THE SUPERIOR OIL
COMPANY
PERMIT ISSUED: 02/18/1965
PERMIT CLOSED: 10/21/1966
FILE LOCATION: 7N-1E-15 SESE

TARGET CODES:

WELL HISTORY / CHECKLIST

PERMIT TO DRILL / INTENT TO DRILL

WELL INSPECTION / SCOUT REPORTS

OPERATOR'S TECHNICAL REPORTS / MAPS

ADMINISTRATIVE / SUNDRY REPORTS

CORRESPONDENCE

SURETY

MISCELLANEOUS

WELL HISTORY / CHECKLIST



WELL HISTORY

Well Name Superior Oil #1 Peterson 44-15 Permit No. 382

Location SESE 15-7S-1E - Fall River Date of Permit 2-18-65

Elev. 3576 Gr. API No. _____

Confidential _____ From _____ To _____

Logs Received _____

Cuttings Received _____ Cores Received _____

Drill Stem Records _____

Cap Plug and Marker Set _____

Surface Restored _____

Plugging Affidavit Signed _____ Date _____

Board Released _____ Date 10-21-66

Summary of Scout Reports

2-19-65 First report

2-24-65 Spudded 2-20-65

3-4-65 Plugged

3-5-65 Planned to convert test to water well

4-9-65 Pits not filled - Rig still on location

5-25-65 Mud pits not filled - Rig moved from location

7-30-65 Pits not filled

7-1-66 Pits not filled



Hydro ID 4

Superior #1 (44-12) Peterson
660 FSL, 660 FEL
SE SE, -15-75-1 E
Fall River Co

Surface + mineral owner.
F.A. Peterson
Ely, Mont, So. Dak.

Contractor: Barnhart Drilling Co.
Casper, Wyo.

Elev: 3576 ^{gt}
3585 K.B.

Est T.O. 2500 1st Sec.

Perm. #: 2-18-65 #382.

Plan to Set 500' 8 5/8, Cement test
1st Sec. + Run dual instructions - include
+GRS

Water flow at about 400

Errors #7 Rainbow.

971' 8 5/8

March 2, 1965

Coming at 2175'

© 2179

986.54 of 8 5/8

w/ 450 of 4 Cms.
+ 125 sec
Cement 971.

Dave Benson - G.S.

2-19-65

John Ryan of P.I.
Called + said Barnhart
was Contractor + they were
on location.

2-20-65

Duiker Called at 11:00
A.M. said Barnhart was
Contractor + had spudded
at 1:30 AM 2-20-65

~~Don Brauer - Eng. pusher.~~
Don Brauer - Eng. pusher.
(w/you will not be out until
reach minimum)

Not Title
nothing will be title.

Feb 24, 1965

© 974

est by P. Peterson

mx

top log E.

Dish 185

Set 371

mem 471

Sum 670

771 top Sum rod.

Sample top

mk. - 1527

ml - 1652

Lake + Sum flowed.

1st Sec being Cased.

est. T.O. 2500



PERMIT TO DRILL / INTENT TO DRILL



State Pub. Co., Pierre

APPLICATION FOR PERMIT TO:

S. Dak Oil & Gas Board FORM 2

<input checked="" type="checkbox"/> DRILL	<input type="checkbox"/> DEEPEN	<input type="checkbox"/> PLUG BACK	FARM OR LEASE NAME Peterson WELL NO. #1 (44-15)
<input checked="" type="checkbox"/> OIL WELL	<input type="checkbox"/> GAS WELL	<input type="checkbox"/> SINGLE ZONE <input type="checkbox"/> MULTIPLE ZONE	
OPERATOR The Superior Oil Company			FIELD AND POOL, OR WILDCAT
ADDRESS P. O. Box 200, Casper, Wyoming			NO. ACRES IN LEASE 2846.03
LOCATION (in feet from an established corner of the legal subdivision) 660' FSL & 660' FEL Sec. 15-7S-1E			1/4 SEC. TWP. RGE SE SE 15-7S-1E COUNTY Fall River
NAME AND ADDRESS OF SURFACE OWNER F. A. Peterson Edgemont, South Dakota		ELEVATION 3576 G.L. PROPOSED DEPTH 2500'	NO. OF WELLS ETC. ROTARY OR CABLE TOOLS Rotary
NAME AND ADDRESS OF CONTRACTOR Unknown		APPROXIMATE DATE WORK WILL START 2-22-65	

IF LEASE PURCHASED WITH ANY WELLS DRILLED, FROM WHOM PURCHASED (Name and address)

PROPOSED CASING AND CEMENTING PROGRAM					
SIZE OF HOLE	SIZE OF CASING	WEIGHT PER FOOT	NEW OR SECOND HAND	DEPTH	SACKS OF CEMENT
12-1/4"	8-5/8"	24#	New	500	300

DESCRIBE PROPOSED OPERATIONS. IF PROPOSAL IS TO DEEPEN OR PLUG BACK, GIVE DATA ON PRESENT PRODUCTIVE ZONE AND PROPOSED NEW PRODUCTIVE ZONE GIVE BLOW OUT PREVENTER PROGRAM IF ANY

- (1) The Superior Oil Company proposes to drill a 2500' 1st Leo Sand test at the above location.
- (2) Will set 8-5/8" csg. at 500' & cmt. to surface.
- (3) Will drill 7-7/8" hole to total depth.
- (4) Will catch 10' samples from base of surface to TD.
- (5) Expect to core & test the 1st Leo Sand plus any other zones that have significant shows.
- (6) Will run Dual Induction-Laterolog & GRS logs from TD to base of surf. csg.
- (7) Should commercial production be encountered, 5-1/2" casing will be cemented through the productive zone.

SIGNED: *J. P. Burke* TITLE District Engineer DATE 2-11-65

DO NOT WRITE BELOW THIS LINE

CHECK NO. 2092 CHECKED BY *Bernard Linn* 2/17/65
School and Public Lands
APPROVAL DATE *2/17/65* Secretary

- CONDITIONS:
- (1) COMPLETE SET OF SAMPLES, AND CORES IF TAKEN, MUST BE SUBMITTED.
 - (2) SAMPLES, AND CORES IF TAKEN, BELOW ... DEPTH, MUST BE SUBMITTED.

INSTRUCTIONS

General: This form is designed for submitting proposals to perform certain well operations, as indicated, on all types of lands and leases for appropriate action by either a Federal or a State agency, or both, pursuant to applicable Federal and/or State laws and regulations (consult applicable Federal or State regulations, or appropriate officials, concerning approval of the proposal before operations are started).

If the proposal is to redrill to the same reservoir at a different subsurface location or to a new reservoir, use this form with appropriate notations.

If the well is to be, or has been, directionally drilled, so state and show by attached sheets, if necessary, the coordinate location of the hole in any present or objective productive zones.

File 3 copies of this form with Secretary, Oil & Gas Board, Pierre.

(*Sample location: 600' South and 600' East of the Northwest Corner of Section 16.)



TRI-STATE COMPANY

Hydro ID 4

X 737

740-47

8 of 83

N. W. Corner

NEWCASTLE, WYOMING

N. E. Corner

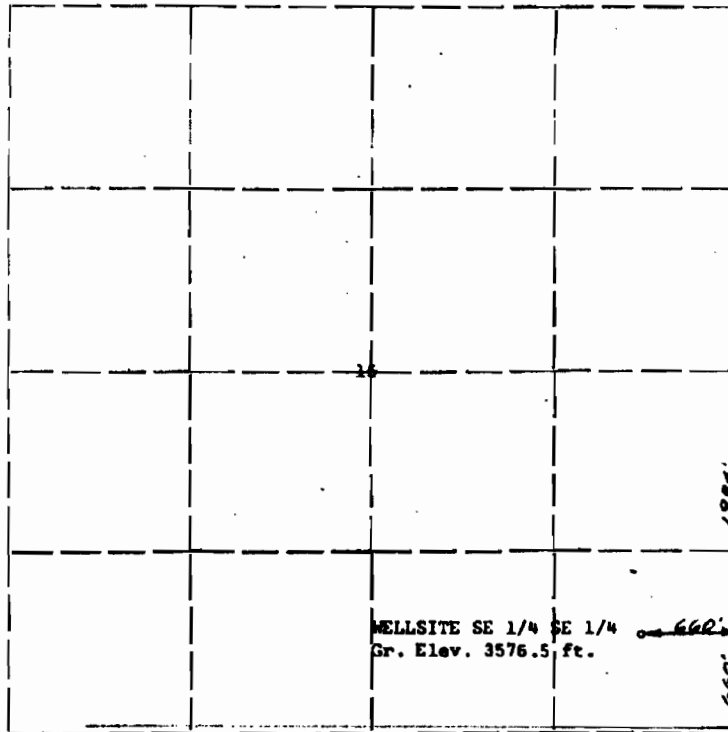

S. W. Corner

S. E. Corner

I, Laurence T. Price, of Newcastle, Wyoming, Certify
 that in accordance with a request from J. P. Dulka
 of Casper, Wyoming, for The Superior Oil Company
P. O. Box 200, Casper, Wyoming

I made a survey (date) February 9 1965
 for the location and elevation of the Peterson No. 1 (44-15) oil
well site

As shown on above map, the well site is in center SE 1/4 SE 1/4
 Section 15, Township 7 South ~~XXXX~~ Range 1 East ~~XXXX~~
Fall River County, ~~Wyoming~~ ^{South Dakota}. Elevation is 3576.5 feet
above mean sea level before dozing.

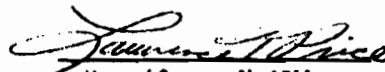
 Licensed Surveyor No. 1311

WELL INSPECTION / SCOUT REPORTS

STATE GEOLOGICAL SURVEY

Scout Report

Date Scouted 7/1/66

Owner Superior Oil Company

Designation of well #1 Peterson (44-15)

Location: Sec. 15 T. 7 N. S. R. 1 E. W.
Fall River County, S. D. Total depth 2264 feet

Casing Record:

8 5/8 971 Ft. _____ Ft.
_____ Ft. _____ Ft.

Work in progress at time of visit:

None

Developments since last visit:

None

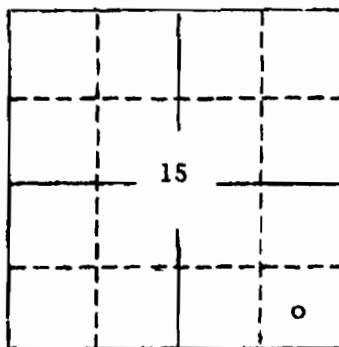

Remarks and recommendations:

Pits not filled

Scouted by Earl Cox, Geologist

Approved by *Duncan J. McGregg*
Duncan J. McGregg, State Geologist

Permit No. 382

STATE GEOLOGICAL SURVEY

Scout Report

Date Scouted July 30, 1965

Owner Superior Oil Company

Designation of well #1 Peterson (44-15)

Location: Sec. 15 T. 7 N. S. R. 1 E.W.

Fall River County, S. D. Total depth 2264 feet

Casing Record:

8 5/8 971 Ft. _____ Ft.

_____ Ft. _____ Ft.

Work in progress at time of visit:

None

Developments since last visit:

None

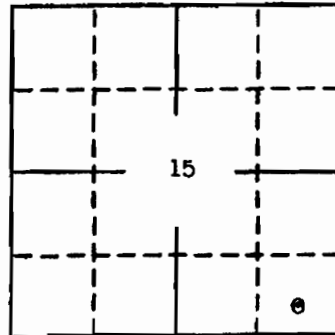

Remarks and recommendations:

Pits not filled

Scouted by Earl Cox, Geologist

Approved by Duncan J. McGregor, State Geologist



STATE GEOLOGICAL SURVEY

Scout Report

Date Scouted May 25, 1965

Owner Superior Oil Company

Designation of well #1 Peterson (44-15)

Location: Sec. 15 T. 7 N. S. R. 1 B. W.

Fall River County, S. D. Total depth 2,264 feet

Casing Record:

8 5/8 971 Ft. Ft.

 Ft. Ft.

Work in progress at time of visit:

None

Developments since last visit:

Rig moved from location

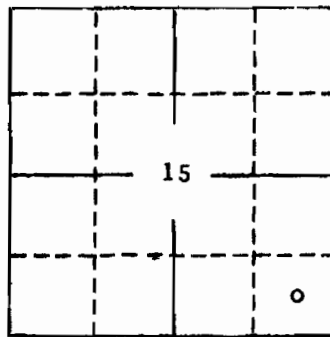

Remarks and recommendations:

Mud pits not filled

Scouted by Earl Cox, Geologist

Approved by *Duncan J. McGregg*
Duncan J. McGregg, State Geologist



Hydro ID 4

Permit No. ^{13 of 63} 382

STATE GEOLOGICAL SURVEY

Scout Report

Date Scouted April 9, 1965

Owner Superior Oil Company

Designation of well #1 Petersen (44-15)

Location: Sec. 15 T. 7 N. S. R. 1 E. W.

Fall River County, S. D. Total depth 2264 feet

Casing Record:

8 5/8 971 Ft. Ft.

 Ft. Ft.

Work in progress at time of visit:

None, well is flowing at about 10 gpm

Developments since last visit:

A three-inch control valve is in place on the well head.

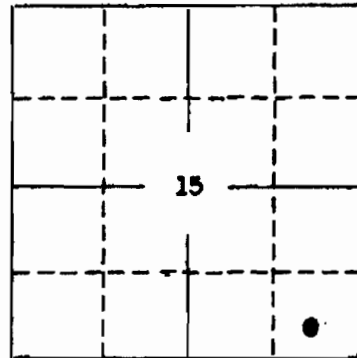

Remarks and recommendations:

Pits have not been filled.
Rig is still over location.

Scouted by Earl Cox, Geologist

Approved by

Duncan J. McGregor
Duncan J. McGregor, State Geologist



STATE GEOLOGICAL SURVEY

Scout Report

Date Scouted March 5, 1965

Owner Superior Oil Company

Designation of well #1 Peterson (44 - 15)

Location: Sec. 15 T. 7 N. S. R. 1 E. W.

Fall River County, S. D. Total depth 2264 feet

Casing Record:

8 5/8 971 Ft. Ft.
 Ft. Ft.

Work in progress at time of visit:

An artesian flow at the base of the surface casing flushed out the top of the cement plug resulting in a 20-30 gpm flow of fresh water.

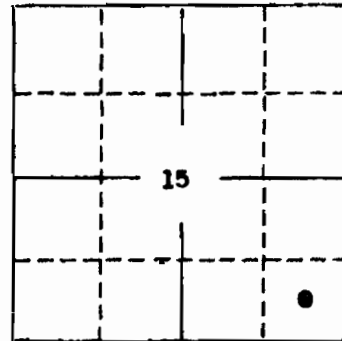

Developments since last visit:

Remarks and recommendations:

The flow is contained by a valve at the surface and it is planned to convert the test to a water well.

Scouted by Earl Cox, Geologist

Approved by *Duncan J. McGregor*
Duncan J. McGregor, State Geologist

STATE GEOLOGICAL SURVEY

Scout Report

Date Scouted March 4, 1966

Owner Superior Oil Company

Designation of well #1 Peterson (44 - 15)

Location: Sec. 15 T. 7 N. S. R. 1 E. N.

Fall River County, S. D. Total depth 2264 feet

Casing Record:

8 5/8 971 Ft. _____ Ft.
 _____ Ft. _____ Ft.

Work in progress at time of visit:
 Plugged as follows:

- 25 sacks 1970-1920 3rd Converse sand
- 35 sacks 1715-1645 Top Minnelusa
- 30 sacks Base surface casing 1020-950

Developments since last visit:

Core #1 2175-2221 anhydrite, Core #2 2221-22644, anhydrite essentially. Leo Sand very tight. No permeability or porosity. Run sonic-gamma ray log and dual induction laterolog (971-T.D.). Run E-log and micro-log prior to setting surface casing. Water flow of about 40 gpm at 890-905 and also a flow after drilling out from under surface casing.

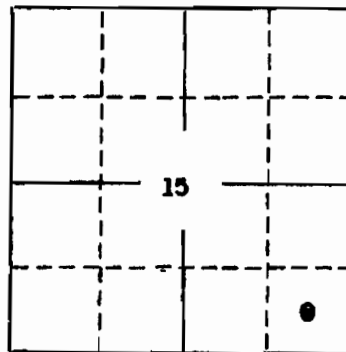

Remarks and recommendations:

Tentative log tops:

Minnekahta - 1518	3rd converse - 1942
Opeche - 1557	Red marker - 2108
Minnelusa - 1645	Base of 1st Leo - 2254
2nd Converse - 1777	T. D. - 2264

Scouted by Earl Cox, Geologist

Approved by 
 Duncan J. McGregor, State Geologist

STATE GEOLOGICAL SURVEY

Scout Report

Date Scouted March 2, 1965

Owner Superior Oil Co.

Designation of well #1 Peterson

Location: Sec. 15 T. 7 N. S. R. 1 E. NE
Fall River County, S. D. Total depth 2179 feet

Casing Record:

8 5/8 971 Ft. _____ Ft.
 _____ Ft. _____ Ft.

Work in progress at time of visit:

Coring at 2179 (1st Leo Sand)

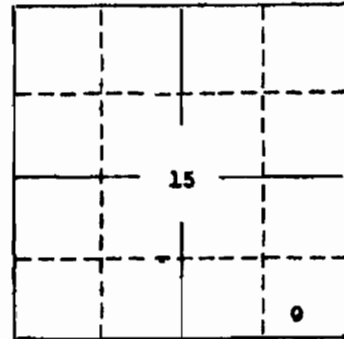

Developments since last visit:

Set 971' of 8 5/8" surface casing with 575 sacks.
 Drilled from 974-2175.
 Cored from 2175-2179.

Artesian flows were encountered in the Lakota and Sundance.

Remarks and recommendations:

E log tops:

Dakota - 185 Sundance - 670
 Lakota - 371 Top Sundance Sand - 771
 Morrison - 471

Sample Tops:

Minnekahta - 1527
 Minnelusa - 1652

Scouted by Earl Cox, Geologist

Approved by *Duncan J. McGregor*
 Duncan J. McGregor, State Geologist

Elevations: 3576 gd; 3585 K.B.

Hydro ID 4

Permit No. ^{17 of 63} 382

STATE GEOLOGICAL SURVEY

Scout Report

Date Scouted Feb. 24, 1965

Owner Superior Oil Co.

Designation of well #1 Peterson (44-15)

Location: Sec. 15 T. 7 N. S. R. 1 E. NW.

Fall River County, S. D. Total depth 974 feet

Casing Record:

_____ Ft. _____ Ft.

_____ Ft. _____ Ft.

Work in progress at time of visit:

Drilling at 974'.

Developments since last visit:

Spudded 2-20-65.
Drilled from 0 - 974.
Run electric log to locate water sands.

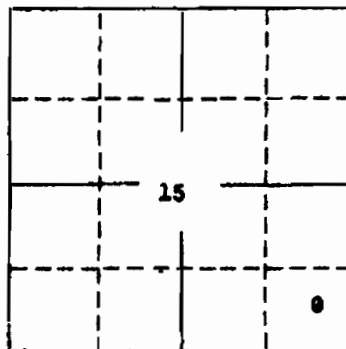

Remarks and recommendations:

Over 900 feet of surface casing will be set to case off artesian flows.

Scouted by Earl Cox, Geologist

Approved by *Duncan J. McGregor*
Duncan J. McGregor, State Geologist



STATE GEOLOGICAL SURVEY

Scout Report

FIRST REPORT

Date Scouted Feb. 19, 1965

Owner Superior

Designation of well #1 (44-15) Peterson

Location: Sec. 15 T. 7 N. S. R. 1 E. XIV

Fall River County, S. D. Total depth 0 feet

Casing Record:

_____ Ft. _____ Ft.
_____ Ft. _____ Ft.

Work in progress at time of visit:

Petroleum information informed me by phone that Barnhart Drilling Company was the contractor and they were on location.

Developments since last visit:

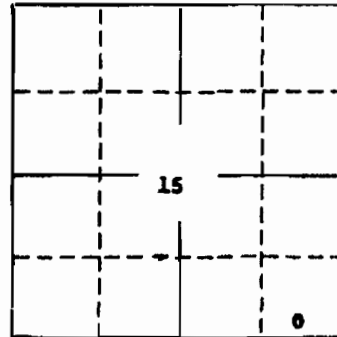

Remarks and recommendations:

Scouted by Earl Cox, Geologist

Approved by *Duncan J. McGregor*
Duncan J. McGregor, State Geologist



Hydro ID 4

8:45 AM

March 4, 1965

Don Brance Called. Found Reached 2264 + found the sand very nice + no shows. plan to log + then plug

petroleum plus 662-6222

Sanin log - gamma Ray Read 100 ✓ lithology on surface. find indicator lithology.

Temperature log top

m/c - 1558

gyp - 1557

m/c - 1645

2nd casing 1777

3rd " 1742

Red marker - 2108

Base of hole 2254

T.P. 2264

2nd casing 1970-1920

3rd Case. 1970-1920 25sf

T. ml 1715-1645 35sf

Kir Sygne 1020-950 30sf

90. sf

7:30 - 8:00

7:45 A.M. to check plug.

62-7244

Room 7

Don Brance

Case #1 2175-2228

only bits. Rec 44'

Case #2 2228-2264

only part - essentially

Good water at

890-905 or 925

27 liter 1 gal/min

plug Kir Sygne Co

970
45
25
45

30 sf - ~~700-950~~

1020 - 950-950

25M - 3rd casing 1970-1920

3rd top ml 1645-1715

970 cm stand will process samples

March 5, 1965

Brance called at 10:00 AM I finally got hold of him at about 7:00 P.M. He got a flow of water from the well flowing a 2" stream at an estimated 20 g/m. Had put valve of surface & shut in.

A sand zone immediately below surface had apparently broken loose. (A flow was observed when drilled out from under surface) Rig had been run down + part hauled off for repair. We decided to put steel Bahr plug at base of casing + put 10' cement at top of it.



March 6, 1965

Called Brown @ 8:30 AM
 He said he was just
 some water was coming
 from base of surface. Said
 maybe want to pump
 from there. I said could it
 be done but would
 see McNoy about it.
 Brown said an alternative
 that would save the
 money would be to pump
 60 ft down hole and
 shut in after reaching
 the sand. This would
 draw about 100' of
 cement in casing &
 rammer would have
 to drift it out. I
 said this would be
 a satisfactory alternative.
 Brown would be
 done in week of 10 days
 after they evaluate cost.

using cement would cost
 about 500. If they did
 they about 1000.

Dwyer - pronounced Dika

3-8-65

Called McNoy, Don Brown,
 Francis Peterson, and
 Dwyer and all agreed to
 submit plan to water
 I will get letter from
 Peterson that he request
 a concession

3-17-65

Called Peterson as he had
 not sent back signed letter
 saying he would be consent to
 a water well. He said had
 reduced the part value
 & run it for a week & then
 had stopped to 6:30 PM. He
 was going to sign letter & return.

Apr. 19, 1965

Most hard rain. Nothing
 to report. pits not filled or
 fixed. Head-water was
 on wellhead & was
 flowing about 5-10 gpm

May 25, 1965

By gone from location
 pits not filled

July 30, 1965

no change

Sept. 2, 1965

no change. water from
 well returning into
 mud pits.

July 1, 1966

no change

9-9-66

no change

Hydro ID 4

Remot of 392

Superior #1 Peterson

SE 1/4 SE 1/4, sec 15, T4S, R. 1E
Fall River Co

Geological
spudded

Blk - 3576 3577 KB
Contractor - Northland Oil Co

2-19-65

PT told Earl that Bielle
was at site.

2-24-65

Spudded on 20-15. Drilled
a 479 ft man v-log to locate water
in d. A 900' of surface casing will
be set to case off water and flow

3-2-65

Set 471 feet of 8 1/2" surface with 5 1/2"
case + drilled to 2175' (cored from
2175-2179 (1st sec). Flow is
2-175-2179 in R1 + surface)

(over)



a Slope Hydro 154 185, N1-23 of 63
 471, 185, 170,
 sample type - 1mm bubble 15.1
 185, 170, 152
 3-4-64

Plugged. Core #1 211, 221
 Core #2 221, 224, 224
 200 ft, essentially for each way side
 no gas or gas. Some down - 2R +
 dust at LL (971 TD). At 200 ft
 + no gas. The cutting up of
 at the flow of about 40 gpm at 800-
 900 + also a flow after drilling out
 from under surface log

Tops:

1mm bubble - 1518 2nd course - 1942
 apple - 1558 red. make - 2108
 1mm bubble - 1645 core of 1st sec - 2264
 2nd course - 1777 TD 2264
 3-5-64

Arterial flow at base of surface log
 was seen to plug resulting in a flow of 20-30
 gpm. Flow contained by valve + will connect
 to water well.

3-10-64

Letter from East to station in
 contact with well



Received 2 copies of letter from
Yves van Peteron asking to see
report plug out of hole so well
could be accounted for later with
also 2 copies of core analyses

4-4-65

Well flowing at about 10 gpm
control valve in place. Pits
are filled & very in relation
location

5-10-65

Letter from Col saying don't release
and because pits not filled even
though he should have assumed
responsibility for well

5-25-65

Rig moved from location. Pits
not filled.

7-30-65

Pits not filled

10-1-65

Letter from Cox to Burdock saying water
was open and water running in pits



Hydro ID 4 1-24 of 63 - 65
letter from Carl to Douglas saying
release from Peterson is needed
Petition not filed 7-1-66
9-28-66
Received release signed by
Peterson for file 9-30-66
letter from Carl saying OK to
release bond

Hydro ID 4

25 of 63

WELL: *Superior #1 & 2*

LOCATION:

LOGS RECD:

TOPG:

GEOLOGIC: *2 copies 5/10/66*

ELECTRIC, FIELD:

FINAL: *2 copies of electric log*

2 copies magnetic

RADIO, FIELD:

FINAL: *2 copies of radio log*

OTHERS: *3 copies core analysis*

CUTTINGS RECD: *5/10/66*

CORES RECD: *2 copies of core analysis 5/10/66*

DRILL STEM DATA RECD: ~~2 copies~~

CAV PLUG CHECKED: *converted to water well.*

MUD PITS FILLED: *beton signed release.*

PLUGGING AFFIDAVIT SIGNED:

1 photocopy each of form #27 (to be used in 3-2-66)

BOND RELEASED: *to drill for Lewis aquifer 10-7-66*

10-21-66



OPERATOR'S TECHNICAL REPORTS / MAPS



Case:

Preliminary Report

CORE LABORATORIES, INC.
Petroleum Reservoir Engineering
DALLAS, TEXAS

THE SUPERIOR OIL COMPANY

Page No.

MAR 11 1965

CORE ANALYSIS RESULTS

ENGINEERING
CASPER

Company SUPERIOR OIL COMPANY Formation MINNELUSA File RP-4-1363
Well NO. 1 PETERSON Core Type DIAMOND CONV. Date Report 3-4-65
Field WILDCAT Drilling Fluid WATER BASE Analysts JMM
County FALL RIVER State S. DAKOTA 3576 Gr Location SE SE 15-7S-1E

Lithological Abbreviations

Table with columns: SAND/SL SHALE/SH, DOLOMITE/DOL, ACHTERITE/ANRY, SANDY SDY, FINE FN, CRYSTALLINE SLN, BROWN/BNH, FRACTURED FRAC, SLIGHTLY-SL/VERY S/ WITH W/, SAMPLE NUMBER, DEPTH FEET, PERMEABILITY MILLIDARCY, POROSITY PERCENT, RESIDUAL SATURATION PER CENT PORE OIL, TOTAL WATER, SAMPLE DESCRIPTION AND REMARKS. Rows 1-7.

These analyses, opinions or interpretations are based on observations and materials supplied by the client to whom, and for whose exclusive and confidential use, this report is made. The interpretations or opinions expressed represent the best judgment of Core Laboratories, Inc. (all errors and omissions excepted); but Core Laboratories, Inc. and its officers and employees, assume no responsibility and make no warranty or representation, as to the productivity, proper operations, or profitability of any oil, gas or other mineral well or sand in connection with which such report is used or relied upon.



Superior Oil Company, 44-15 Petersen Description by: D. A. Bentzin
C SE SE Section 15, T 7 S, R 1 E
Fall River County, South Dakota

Elevation: 3576G, 3585KB

- 974- 980 Shaly siltstone, dark reddish brown, calc, NS.
- 980- 990 Siltstone, aa, NS.
- 990-1000 Siltstone, aa, NS.
- 1000-1010 Siltstone, dark reddish brown, calc, NS.
- 1010-1020 Siltstone, dark reddish brown, calc, NS.
- 1020-1030 Siltstone, dark reddish brown, calc, NS.
- 1030-1040 Shaly siltstone, dark reddish brown, calc, NS.
- 1040-1050 Shaly siltstone, dark reddish brown, calc, NS.
- 1050-1060 Shaly siltstone, dark reddish brown, calc, with minor anhydrite, NS.
- 1060-1070 Shaly siltstone, dark reddish brown, calc, with minor anhydrite, NS.
- 1070-1080 Shaly siltstone, dark reddish brown, calc, NS.
- 1080-1090 Shaly siltstone, dark reddish brown, calc, NS.
- 1090-1100 Shaly siltstone, dark reddish brown, calc, NS.
- 1100-1110 Shaly siltstone, dark reddish brown, calc, NS.
- 1110-1120 Shaly siltstone, dark reddish brown, calc, NS.
- 1120-1130 Shaly siltstone, dark reddish brown, calc, NS.
- 1130-1140 Shaly siltstone, dark reddish brown, calc, NS.
- 1140-1150 Shaly siltstone, dark reddish brown, calc, NS.
- 1150-1160 Shaly siltstone, dark reddish brown, calc, NS.
- 1160-1170 Shaly siltstone, dark reddish brown, calc, NS.
- 1170-1180 Shaly siltstone, dark reddish brown, calc, with minor anhydrite, NS.
- 1180-1190 Shaly siltstone, dark reddish brown, calc, with minor anhydrite, NS.
- 1190-1200 Shaly siltstone, dark reddish brown, calc, NS.
- 1200-1210 Shaly siltstone, dark reddish brown, calc, NS.
- 1210-1220 Shaly siltstone, dark reddish brown, calc, with minor anhydrite, NS.
- 1220-1230 Shaly siltstone, dark reddish brown, calc, with minor anhydrite, NS.
- 1230-1240 Shaly siltstone, dark reddish brown, calc, with minor anhydrite, NS.
- 1240-1250 Shaly siltstone, dark reddish brown, calc, with minor anhydrite, NS.



Superior Oil Company, 44-15 Petersen
C SE SE Section 15, T 7 S, R 1 E
Fall River County, South Dakota
Page 2

- 1250-1260 Shaly siltstone, dark reddish brown, calc, with minor anhydrite, NS.
- 1260-1270 Shaly siltstone, dark reddish brown, calc, with minor anhydrite, NS.
- 1270-1280 Shaly siltstone, dark reddish brown, calc, with minor anhydrite, NS.
- 1280-1290 Shaly siltstone, dark reddish brown, calc, with 10% anhydrite, NS.
- 1290-1300 Shaly siltstone, dark reddish brown, calc, with 10% anhydrite, NS.
- 1300-1310 Shaly siltstone, dark reddish brown, calc, with minor anhydrite, NS.
- 1310-1320 Shaly siltstone, dark reddish brown, calc, with minor anhydrite, NS.
- 1320-1330 Shaly siltstone, dark reddish brown, calc, with 25% anhydrite, NS.
- 1330-1340 Shaly siltstone, dark reddish brown, slightly calc, with 30% anhydrite, NS.
- 1340-1350 Anhydrite, white, crystalline with shaly siltstone aa, NS.
- 1350-1360 Anhydrite, white, crystalline with shaly siltstone aa, NS.
- 1360-1370 Anhydrite, white, crystalline, decreasing with siltstone as above, NS.
- 1370-1380 Shaly siltstone, dark reddish brown, calc, with 25% anhydrite, NS.
- 1380-1390 Shaly siltstone, dark reddish brown, calc, with 25% anhydrite, NS.
- 1390-1400 Shaly siltstone, dark reddish brown, calc, with 10% anhydrite, NS.
- 1400-1410 Anhydrite, white, crystalline with shaly siltstone aa, NS.
- 1410-1420 Anhydrite and shaly siltstone, aa, 50-50, NS.
- 1420-1430 Anhydrite and shaly siltstone, aa, 50-50, NS.
- 1430-1440 Shaly siltstone, dark reddish brown, slightly calc, with minor anhydrite, NS.
- 1440-1450 Shaly siltstone, dark reddish brown, calc, with minor anhydrite, NS.
- 1450-1460 Shaly siltstone, dark reddish brown, calc, with minor anhydrite, NS.
- 1460-1470 Shaly siltstone, dark reddish brown, slightly calc, with minor anhydrite, NS.



Superior Oil Company, 44-15 Petersen
C SE SE Section 15, T 7 S, R 1 E
Fall River County, South Dakota
Page 3

- 1470-1480 Shaly siltstone, dark reddish brown, slightly calc, with minor anhydrite, NS.
- 1480-1490 Shaly siltstone, dark reddish brown, slightly calc, with minor anhydrite, NS.
- 1490-1500 Shaly siltstone, dark reddish brown, slightly calc, with minor anhydrite, NS.
- 1500-1510 Shaly siltstone, dark reddish brown, slightly calc, with minor anhydrite, NS.
- 1510-1520 Shaly siltstone, dark reddish brown, calc, with minor anhydrite, NS.
- 1520-1530 40% Shaly siltstone, aa, with 10% white anhydrite and 20% dolomite, pink, very fine granular to dense, slow effervescence, NS.
- 1530-1540 Shaly siltstone, anhydrite and dolomite, aa, in equal parts. The dolomite is varicolored - white, pink, tan, NS.
- 1540-1550 Sample aa, with minor calcareous purple shale, NS.
- 1550-1560 Sample aa, with minor calcareous purple shale, NS.
- 1560-1570 Sample aa, with no purple shale, NS.
- 1570-1580 Sample aa, NS.
- 1580-1590 Sample aa, NS.
- 1590-1600 Sample aa, NS.
- 1600-1610 Silty shale to siltstone, reddish brown, slightly calc, with minor anhydrite, NS.
- 1610-1620 Silty shale to siltstone, reddish brown, slightly calc, with minor anhydrite, NS.
- 1620-1630 Silty shale to siltstone, reddish brown, slightly calc, with minor anhydrite, NS.
- Note The Opache lithology is similar to the pre-Minnekahta with the exception that the silt grains seem generally smaller.
- 1630-1640 Shaly siltstone, reddish brown, calc, with minor anhydrite, NS.
- 1640-1650 Sample aa, with sandy siltstone, reddish brown, slightly calc, soft and sandstone, gray to pink, fine grained, non-calc poor porosity, NS.
- 1650-1660 Sample aa, with sandstone, pink to white, fine to medium grained, fair sorting, slightly calc, poor porosity, grains appear to have secondary overgrowths, NS.
- 1660-1670 Sandy siltstone, reddish brown, and sandstone aa, NS.
- 1670-1680 Sample aa, with sandy siltstone predominant, NS.
- 1680-1690 Sample aa, with sandstone increasing to 30%, NS.



Superior Oil Company, 44-15 Petersen
C SE SE Section 15, T 7 S, R 1 E
Fall River County, South Dakota
Page 4

- 1690-1700 Sample aa, with sandstone increasing to 30%, with minor anhydrite, NS.
- 1700-1710 Sample aa, with sandstone increasing to 30%, with minor anhydrite, NS.
- 1710-1720 Sample aa, with sandstone increasing to 30%, with minor anhydrite, NS.
- 1720-1730 60% Anhydrite, white, crystalline with silty shale, reddish brown and minor sandstone, NS.
- 1730-1740 Sample aa, NS.
- 1740-1750 Dolomite, white to pink, dense, with anhydrite aa, NS.
- 1750-1760 Dolomite, white to pink to gray, dense, with anhydrite aa, NS.
- 1760-1770 Sandy siltstone, reddish brown, calc, with minor anhydrite, NS.
- 1770-1780 Sandy siltstone, reddish brown, calc, with minor anhydrite, NS.
- 1780-1790 Sandy siltstone, reddish brown, calc, with minor sandstone, white to pink, fine grained, angular, well sorted, poor porosity anhydrite cement, NS.
- 1790-1800 Sandy siltstone and sandstone aa, with anhydrite, NS.
- 1800-1810 Shale, reddish brown with siltstone and anhydrite aa, NS.
- 1810-1820 Limestone, mottled gray, dense, with lithology aa, NS.
- 1820-1830 Limestone, mottled gray, dense, with lithology aa, NS.
- 1830-1840 Shaly siltstone, reddish brown, slightly calc, with limestone and anhydrite aa, NS.
- 1840-1850 Sample aa, NS.
- 1850-1860 Sample aa, with minor white sandstone, fine grained, poor porosity, NS.
- 1860-1870 Limestone aa, with shaly siltstone and anhydrite aa, NS.
- 1870-1880 Limestone aa, with shaly siltstone and anhydrite aa, NS.
- 1880-1890 Limestone aa, with shaly siltstone and anhydrite aa, NS.
- 1890-1900 Shaly siltstone increasing in proportion to limestone and anhydrite with minor sandstone, white very fine grained, angular, no porosity, grains are anhydrite encased, NS.
- 1900-1910 Sample aa, NS.
- 1910-1920 Shaly siltstone to silty shale, reddish brown, soft calc, and anhydrite, white, granular with minor limestone, pink, dense, NS.
- 1920-1930 60% Shaly siltstone aa, 30% anhydrite aa, 10% limestone aa, NS.

Superior Oil Company, 44-15 Petersen
C SE SE Section 15, T 7 S, R 1 E
Fall River County, South Dakota
Page 5

- 1930-1940 Sample aa, NS.
- 1940-1950 Silty shale, reddish brown, slightly calc, soft with minor anhydrite, NS.
- 1950-1960 Silty shale, reddish brown, slightly calc, soft with minor anhydrite and sandstone, white, very fine grained, non-calc, tight, NS.
- 1960-1970 Silty shale and minor anhydrite aa, no sandstone, NS.
- 1974 Lost circulation - No sample 1970-1980.
- 1980-1990 75% cave, 25% sample aa, NS.
- 1990-2000 75% cave, 25% sample aa, NS.
- 2000-2010 75% cave, 25% sample aa, NS.
- 2010-2020 30% cave and silty shale, reddish brown, non-calc, soft with minor anhydrite and limestone, NS.
- 2020-2030 Sample aa, with sandstone, pink, fine to very fine grained, sub-angular, fair sorting dolomite cement, poor porosity, NS.
- 2030-2040 Sandstone aa, NS.
- 2040-2050 Sandstone aa, except very fine to medium grained sub-rounded poor sorting, poor porosity, NS.
- 2050-2060 Sandstone aa.
- 2060-2070 Anhydrite, white, with minor dolomite, pink and gray, dense and sandstone aa, with one chip shaly siltstone, red, slightly calc, hard, NS.
- 2070-2080 Sample aa, with 10% siltstone aa, NS.
- 2080-2090 Sample aa, with 10% siltstone aa, NS.
- 2090-2100 Anhydrite and limestone aa, NS.
- 2100-2110 Anhydrite and limestone aa, with sandstone white to lavender, very fine to fine grained, poor sorting, slightly calc to non-calc, NS.
- 2110-2120 Dolomite, tan to gray, dense; anhydrite, white, crystalline, shale, red, soft; sandstone white to lavender, very fine to fine grained, poor sorting, slightly calc to non-calc, tight, NS.
- 2120-2130 Sample aa, with sandstone white, very fine to fine grained, fair sorting, rounded, slight effervescence, fair porosity, NS.
- 2130-2140 Dolomite and shale aa, with white sandstone aa, NS.
- 2140-2150 Increasing white sandstone with shale aa, NS.
- 2150-2160 Shale aa, with dolomite aa and decreasing sandstone aa, with minor black shale, soft, slightly calc, NS.
- 2160-2170 Sample aa, with increasing black shale and limestone, NS.
- 2170-2175 Sample aa, NS.
- 2175-2221 Core #1, see detailed description.
2221-2264 Core #2, see detailed description.
Total Depth 2264'.

The Superior Oil Company, #44-15 Peterson
C SE SE Section 15, T 7 S, R 1 E
Fall River County, South Dakota

CORE #1 2175-2221 Cored 46 feet, Recovered 44 feet.

- 2175-76 Dolomite, black, finely crystalline, tight, NS.
- 2176-77 Anhydrite and dolomite, mottled light and dark gray, coarsely crystalline, tight, NS.
- 2177-78 Anhydrite, light to dark gray, tight, NS.
- 2178-79 Anhydrite, aa, with reddish-brown dolomite mottling, tight, NS.
- 2179-80 Dolomite, light gray, finely crystalline with minor clear anhydrite crystals and black shale mottling, NS.
- 2180-81 Dolomite, light gray, dense, mottled with clear anhydrite and red spots, NS. Some of the anhydrite has the curved shape of shell fragments.
- 2181-82 Sample aa, NS.
- 2182-83 Sandstone, gray, very fine-grained, subrounded, dolomitic and anhydritic cement, hard and tight, NS.
- 2183-84 Sample aa, NS.
- 2184-85 Anhydrite, mottled white and gray, tight, NS.
- 2185-86 Shale, dark gray, anhydritic, NS.
- 2186-87 Anhydrite, gray, very finely crystalline, dolomitic and very silty, NS.
- 2187-88 Anhydrite, light gray, sandy, very fine grained, NS.
- 2188-89 Sandstone, light gray, very fine to medium-grained, poorly sorted, dolomitic and anhydritic, tight, NS.
- 2189-90 Sandstone, light gray, very fine to medium-grained, poorly sorted, dolomitic and anhydritic, tight, NS.
- 2190-91 Sandstone, light gray, very fine to medium-grained, poorly sorted, dolomitic and anhydritic, tight, NS.
- 2191-92 Sandstone, light gray, very fine to medium-grained, poorly sorted, dolomitic and anhydritic, tight, NS.
- 2192-93 Sandstone, light gray, very fine to fine-grained, anhydritic cement, tight, NS.
- 2193-94 Anhydritic, gray with white dolomite mottling, tight, NS.
- 2194-95 Anhydrite, gray and white mottled, NS.
- 2195-96 Anhydrite, gray and white mottled, NS.
- 2196-97 Anhydrite, gray and white mottled, NS.



Superior, #44-15 Peterson
Core #1
Page 2

2197-98 Anhydrite, gray and white mottled, NS.
2198-99 Anhydrite, gray and white mottled, NS.
2199-2200 Anhydrite, gray and white mottled, NS.
2200-01 Anhydrite, gray and white mottled, NS.
2201-02 Anhydrite, gray and white mottled, NS.
2202-03 Anhydrite, aa, mottled with reddish-brown dolomite,
tight, NS.
2203-04 Sample aa, NS.
2204-05 Sample aa, NS.
2205-06 Anhydrite, mottled light and dark gray, NS.
2206-07 Anhydrite, mottled light and dark gray, NS.
2207-08 Anhydrite, mottled light and dark gray, with minor
dolomite, NS.
2208-09 Anhydrite, mottled light and dark gray and black,
with minor dolomite, NS.
2209-10 Anhydrite, aa, with $\frac{1}{4}$ -inch tan dolomite layers,
no dip, tight, NS.
2210-11 Dolomite, gray, finely crystalline, with veinlets of
black anhydrite, tight, NS.
2211-12 Thin laminae of black anhydrite and light gray sandy
dolomite, tight, NS.
2212-13 Sandstone, black, very fine-grained, with anhydrite
cement, tight, NS.
2213-14 Anhydrite, mottled light and dark gray with tan
dolomite mottling, NS.
2214-15 Dolomite, tan to light gray, mottled with dark gray
anhydrite, tight, NS.
2215-16 Black shale, anhydritic with gray anhydrite laminae,
NS.
2216-17 Black shale, anhydritic, NS.
2217-18 Dolomite, light gray, very finely crystalline, very
sandy, very fine to fine-grained, NS.
2218-19 Sandstone, light gray, very fine to medium-grained,
subrounded, fair sorting, dolomite cement, tight, NS.

The Superior Oil Company, #44-15 Peterson
C SE SE Section 15, T 7 S, R 1 E
Fall River County, South Dakota

CORE #2 2221-2264 Cored 43 feet, Recovered 43 feet.

- 2221-22 Sandstone, gray, very fine to medium-grained, sub-rounded, fair sorting, dolomitic and anhydritic cement, tight, NS.
- 2222-23 Sandstone, dark gray, very fine to fine-grained, good sorting, anhydritic cement, tight, NS.
- 2223-24 Anhydrite, mottled gray, NS.
- 2224-25 Anhydrite, mottled gray, NS.
- 2225-26 Anhydrite, mottled gray, NS.
- 2226-27 Anhydrite, mottled gray, NS.
- 2227-28 Anhydrite, mottled gray, NS.
- 2228-29 Anhydrite, mottled gray, NS.
- 2229-30 Anhydrite, mottled gray, NS.
- 2230-31 Anhydrite, mottled gray, NS.
- 2231-32 Anhydrite, mottled gray, NS.
- 2232-33 Anhydrite, mottled gray, NS.
- 2233-34 Dolomite, gray, dense with spots of anhydrite; yellow fluorescence in hairline fractures; very slight and very slow cut with acetone. Strong sulfur odor.
- 2234-35 Dolomite, aa, tight, NS. Sulfur odor.
- 2235-36 Dolomite, aa, tight with increasing amount of anhydrite, NS.
- 2236-37 Anhydrite, gray, dense, NS.
- 2237-38 Dolomite and anhydrite, gray, very finely crystalline, very sandy, fine to very fine grains, slight porosity, NS.
- 2238-39 Sandstone, fine to medium-grained, rounded to sub-rounded, fair sorting, dolomitic and anhydritic cement. Trace of porosity. NS.
- 2239-40 Anhydrite, gray, very sandy, tight, NS.
- 2240-41 Anhydrite, gray, very sandy, tight, NS.
- 2241-42 Anhydrite, gray, very sandy, tight, NS.
- 2242-43 Anhydrite, gray, very sandy, tight, NS.
- 2243-44 Sandstone, gray, very fine to fine-grained, sub-rounded, fair sorting, dolomitic and anhydritic cement, tight, NS.



Superior, #44-15 Peterson
Core #2
Page 2

2244-45	Sandstone, aa, tight, NS.
2245-46	Sandstone, gray, fine to medium-grained, anhydritic cement, tight, NS.
2246-47	Anhydrite, black, silty, tight, NS.
2247-48	Anhydrite, black, silty, tight, NS.
2248-49	Anhydrite, gray, dolomitic, tight, NS.
2249-50	Sandstone, gray, very fine to fine-grained, sub-rounded, anhydritic cement, tight, NS.
2250-51	Sandstone, gray, very fine to fine-grained, sub-rounded, anhydritic cement, tight, NS.
2251-52	Sandstone, gray, very fine to fine-grained, sub-rounded, anhydritic cement, tight, NS.
2252-53	Sandstone, gray, very fine to fine-grained, sub-rounded, anhydritic cement, tight, NS.
2253-54	Sandstone, gray, very fine to fine-grained, sub-rounded, anhydritic cement, slight porosity, NS.
2254-55	Anhydrite, mottled gray, dense, with streaks of tan dolomite and very fine-grained pyrite, tight, NS.
2255-56	Anhydrite, mottled gray, dense with streaks of tan dolomite, tight, NS.
2256-57	Sample aa, NS.
2257-58	Sample aa, NS.
2258-59	Sample aa, NS.
2259-60	Dolomite, light gray, dense, tight, NS.
2260-61	Dolomite, light gray, dense, tight with small spots of anhydrite, NS.
2261-62	Sample aa, NS.
2262-63	Sample aa, with minor spots of very finely crystalline pyrite, NS.
2263-64	Sample aa, NS.



SOUTH DAKOTA STATE GEOLOGICAL SURVEY

COUNTY

DATE

TOWNSHIP 7S

By

RANGE 1E

N

W

E

36	31	32	33	34	35	36	31
1	6	5	4	3	2	1	6
12	7	8	9	10	11	12	7
13	18	17	16	15	14	13	18
24	19	20	21	22	23	24	19
25	30	29	28	27	26	25	30
36	31	32	33	34	35	36	31
1	6	5	4	3	2	1	6

S



ADMINISTRATIVE / SUNDRY REPORTS



MAR 7 5 1966

S. Dak. Oil & Gas Board FORM 7

PLUGGING RECORD

Operator The Superior Oil Company		Address P. O. Box 200, Casper, Wyoming		
Name of Lease Peterson		Well No. 1 (44-14)	Field & Reservoir Wildcat	
Location of Well 660' FSL & 660' FEL C SE SE 15-7S-1E		Sec-Twp-Rge or Block & Survey		County Fall River
Application to drill this well was filed in name of The Superior Oil Co.	Has this well ever produced oil or gas No	Character of well at completion (initial production): Oil (bbls/day) Gas (MCF/day) Dry? Yes		
Date plugged: March 5, 1965	Total depth 2264'	Amount well producing when plugged: Oil (bbls/day) Gas (MCF/day) Water (bbls/day)		
Name of each formation containing oil or gas. Indicate which formation open to well-bore at time of plugging	Fluid content of each formation	Depth interval of each formation	Size, kind & depth of plugs used. Indicate zones squeeze cemented, giving amount cement	

CASING RECORD

Size pipe	Put in well (ft.)	Pulled out (ft.)	Left in well (ft.)	Give depth and method of parting casing (shot, ripped, etc.)	Packers and shoes
8-5/8"	971	None	971		Guide shoe @ 971, float collar @ 937 & basket @ 688'.

Was well filled with mud-laden fluid, according to regulations?
Yes

Indicate deepest formation containing fresh water
Bsl. Sundance Sd.

In addition to other information required on this form, if this well was plugged back for use as a fresh water well, give all pertinent details of plugging operations to base of fresh water sand, perforated interval to fresh water sand, name and address of surface owner, and attach letter from surface owner authorizing completion of this well as a water well and agreeing to assume full liability for any subsequent plugging which might be required.

Mr. Earl J. Cox of the State Geological Survey supervised the plugging operations. This well was plugged & abandoned in the following manner:
 Plug #1 - Equalized through open end DP 25 sx reg. cmt. from 1970' to 1920'
 Plug #2 - Equalized through open end DP 35 sx reg. cmt. from 1715' to 1645'
 Plug #3 - Equalized through open end DP 30 sx reg. cmt. w/2% CaCl₂ from 1020' to 950'
 Removed csg. head & capped well as requested by land owner in attached letter.
 The pits have been fenced and the location will be cleaned & leveled when the pits dry up.

USE REVERSE SIDE FOR ADDITIONAL DETAIL

Executed this the 18th day of March, 1965
 State of Wyoming
 County of Natrona

J. P. Dujka
 Signature of Affiant

Before me, the undersigned authority, on this day personally appeared J. P. Dujka, known to me to be the person whose name is subscribed to the above instrument, who being by me duly sworn on oath states, that he is duly authorized to make the above report and that he has knowledge of the facts stated therein, and that said report is true and correct.

Subscribed and sworn to before me this 18th day of March, 1965

SEAL
 My commission expires June 10, 1967

Notary Public in and for Natrona County, Wyoming

Approved 10-21-66 Date
 OIL AND GAS BOARD OF THE STATE OF SOUTH DAKOTA
 Secretary

Approved for release of bond Date Oct 10, 1966
 State Geologist
 Note: File 2 copies of this form with Secretary, Oil & Gas Board, Pierre.

WELL COMPLETION OR RECOMPLETION REPORT AND LOG

FARM OR LEASE NAME: Peterson

WELL NO.: 1 (44-15)

FIELD AND POOL OR WILDCAT: Wildcat

NO. ACRES IN LEASE: 2846.03

SECTION: 4 1/4 SEC. TWP. RGE. C SE SE 15-7S-1E

COUNTY: Fall River

PERMIT NO.: 2-18-65 DATE ISSUED: 2-18-65 PREVIOUS PERMIT NO.: DATE ISSUED:

DATE SCHEDULED: 2-20-65 DATE T.D. REACHED: 3-3-65 DATE COMPL. (Ready to Prod.): P & A 3-5-65 ELEVATIONS (DP, RKB, RT, GR, etc.): 3585' KB ELEV. CASING HEAD: PAGE

TOTAL DEPTH (MD & TVD): 2265' MD PLUG BACK T.D. (MD & TVD): IF MULTIPLE COMPL. HOW MANY*: INTERVALS DRILLED BY: ROTARY TOOLS: 0' to 2265' CABLE TOOLS:

PRODUCING INTERVAL(S), THIS COMPLETION, TOP, BOTTOM, NAME (MD & TVD)*: DATE DIRECTIONAL SURVEY SUBMITTED:

TYPE ELECTRIC AND OTHER LOGS RUN (Circle those filed): ES, Microlog, Dual Induction - LL & GRS (All filed) WAS WELL CORED: Yes

CASING RECORD (Report all strings set in well)

CASING SIZE	DEPTH SET (MD)	HOLE SIZE	WEIGHT LBS./FT.	PURPOSE	SACKS CEMENT	AMOUNT PULLED
6-5/8"	971	12-1/4"	24#	Surface	625	None

LINER RECORD: TUBING RECORD

SIZE	TOP (MD)	BOTTOM (MD)	SACKS CEMENT*	SCREEN (MD)	SIZE	DEPTH SET (MD)	PACKER SET (MD)

PERFORATION RECORD: ACID, SHOT, FRAC., CEMENT SQUEEZE, Etc.

DEPTH INTERVAL (MD)	HOLES PER FT.	SIZE AND TYPE	PURPOSE	AMOUNT AND KIND OF MATERIAL USED	DEPTH INTERVAL (MD)

PRODUCTION

DATE FIRST PRODUCTION: PRODUCING METHOD (Flowing, gas lift, pumping, size & type of pump): WELL STATUS (Prod or shut in):

DATE OF TEST	HOURS TESTED	CHOKE SIZE	PRODUCTION FOR TEST	OIL, Bbls.	GAS, Mcf.	WATER, Bbls. & %	OIL GRAVITY-API (Cont.)

FLOW TUBING PRESSURE: CASING PRESSURE: CALCULATED 24-HOUR RATE: OIL, Bbls.: GAS, Mcf.: WATER, Bbls. & %: GAS-OIL RATIO:

DISPOSITION OF GAS (Solid, used for fuel, vented, etc.): TEST WITNESSED BY:

LIST OF ATTACHMENTS: 1 copy all E-Logs, 1 copy Core Analysis, 1 copy ltr. from land owner

I hereby certify that the foregoing and attached information is complete and correct as determined from all available records

SIGNED: J. P. Dujka TITLE: District Engineer DATE: 3-15-65

DO NOT WRITE BELOW THIS LINE *See Instructions On Reverse Side

Approved: Date: OIL AND GAS BOARD OF THE STATE OF SOUTH DAKOTA Secretary: *Alvin Larson*

Dist: State Board (3) w/1 copy all attachments.
State Geologist (1) w/2 copies all attachments.

INSTRUCTIONS

General: This form is designed for attaching a complete and correct well completion report and log on all types of lands and leases to either a Federal agency or a State agency, or both, pursuant to applicable Federal and/or State laws and regulations. Supplemental instructions by local Federal and/or State offices will govern the use of this form. If you find prior to the completion of this form that you are unable to comply with the instructions, you should contact the appropriate Federal or State office responsible for the completion of this form. If you are unable to obtain the necessary information, you should contact the appropriate Federal or State office responsible for the completion of this form. If this well was directionally drilled, show both the location at the surface and at total depth from nearest town, where possible; also show the locations at the top and at the bottom of any zone from which production data are reported in space 22, and any zone open for injection or disposal. Use this reverse side if more space is needed. (See-Directional Drilling, page 10 of this form.)

Indicate which direction is used as reference (where not otherwise shown) for depth measurements given in other spaces on this form, and in any attachments.

If this well is completed for hydrocarbon production from more than one zone (multiple-zone completion), so state in the correct space and show the producing interval, top(s), bottom(s) and name(s) (if any) for each zone reported in the blocks under PRODUCTIVE RATE, below a separate completion report on this form for each interval (name) to be separately produced.

"Block Comment": Attached supplemental records for this well should show the details of any multiple stage cementing and the location of the cementing tool.

This is a copy of this form with Secretary, Oil and Gas Board, Pierre.

KIND OF FORMATION	DEPTH TO TOP		DEPTH TO BOTTOM		GEOLOGIC MARKERS
	SEAL DEPTH	TRUE VERT. DEPTH	SEAL DEPTH	TRUE VERT. DEPTH	
Lakota Sd.	371		425		Dakota
Sundance Sd.	771		905		Lakota
Bsl. Sundance Sd.	366		1007		Borriuson
					Sundance
					Sundance Sd.
					Minnesota
					Opeeche
					Minnesota
					Red Marker

41 of 83

Hydro ID 4



CORRESPONDENCE



SCIENCE CENTER, UNIVERSITY OF SOUTH DAKOTA CAMPUS,
VERMILLION, 57069, PHONE 624-4471

WESTERN FIELD OFFICE, 208 GAY BUILDING, BELLE FOURCHE,
BOX 187, 57717, PHONE 692-3121



Western Field Office
October 12, 1966

OCT 13 1966

Mr. Merlin J. Tipton
Assistant State Geologist
State Geological Survey
Vermillion, South Dakota

Dear Tip:

In going through my files, I find that my records show the following oil tests have meet all requirements and can now be released from bond coverage:

- ✓ Superior #1 Peterson (44-15)
Fall River County, South Dakota
- ✓ Gulf #1 Dahlke
Jones County, South Dakota
- ✓ Gulf #1 Sandy
Jones County, South Dakota
- ✓ Gulf #1 Wolf-State
Lyman County, South Dakota.

Sincerely,

Earl Cox
Senior Geologist

EC:rk

UNCAN J. MCGREGOR
DIRECTOR AND STATE GEOLOGIST
VERMILLION

MERLIN J. TIPTON
ASSISTANT STATE GEOLOGIST
VERMILLION

EARL J. COX
SENIOR GEOLOGIST
BELLE FOURCHE



SCIENCE CENTER, UNIVERSITY OF SOUTH DAKOTA CAMPUS,
VERMILLION, 57069, PHONE 624-4471

WESTERN FIELD OFFICE, 208 GAY BUILDING, BELLE FOURCHE,
BOX 187, 57717, PHONE 892-3121

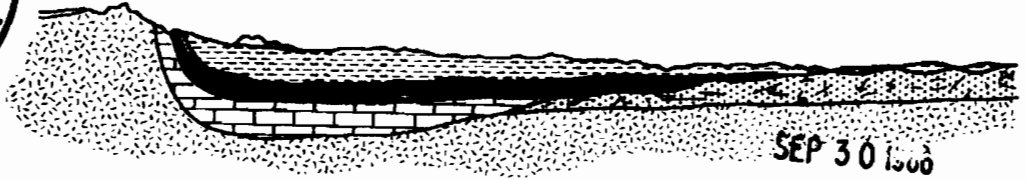

Western Field Office
September 29, 1966

Dr. Duncan McGregor
State Geologist
State Geological Survey
Vermillion, South Dakota

Re: Superior #1 Peterson (44-15)
SESE-15-7S-1E
Fall River County, South Dakota
Permit No. 382

Dear Duncan:

I have received a copy of the RELEASE, signed by Francis Peterson, and the letter showing two copies of the RELEASE has been sent you by Superior Oil Company.

My records show all required samples, logs and records have been received by your office. The RELEASE, completes all requirements and it is recommended the bond covering this location be terminated.

Sincerely,

Earl Cox
Engineering-Petroleum Geologist

EC:rk

DUNCAN J. MCGREGOR
DIRECTOR AND STATE GEOLOGIST
VERMILLION

MERLIN J. TIPTON
ASSISTANT STATE GEOLOGIST
VERMILLION

EARL J. COX
SENIOR GEOLOGIST
BELLE FOURCHE

THE SUPERIOR OIL COMPANY

SUPERIOR BUILDING
P. O. BOX 200
CASPER, WYOMING 82601

SEP 28 1966

September 26, 1966

State Geological Survey
Science Center
University of South Dakota Campus
Vermillion, South Dakota

Re: Peterson No. 1 (44-15)
C SE SE Sec. 15-7S-1E
Fall River Co., South Dakota
Permit No. 382

Gentlemen:

Attached are two (2) copies of a letter agreement executed by Mr. Francis A. Peterson releasing us from all surface damages in connection with the drilling of the above referenced well.

We shall appreciate your approval of our abandonment of this location and the attendant release from bond requirement.

Very truly yours,

THE SUPERIOR OIL COMPANY

J. P. Dujka

JPD:sn

Attached

cc w/attach.: Mr. Earl Cox
South Dakota Geological Survey
Western Field Office
Belle Fourche, South Dakota

THE SUPERIOR OIL COMPANY

SUPERIOR BUILDING
P. O. BOX 200
CASPER, WYOMING 82601
September 20, 1966

RST	_____
JCH	_____
EJW	_____

FILE	_____

THE SUPERIOR OIL
COMPANY

SEP 20 1966

ENGINEERING
CASPER

THE SUPERIOR OIL
COMPANY

SEP 26 1966

LAND DEPARTMENT
CA. PER, WYOMING

Mr. Francis A. Peterson
Edgemont, South Dakota

Re: Peterson #1 (44-15)
C SE SE 15-7S-1E
Fall River County, South Dakota
Permit #382

Dear Mr. Peterson:

Reference is made to Assignment and Agreement dated March 16, 1965 whereby we assigned to you the well in the SE SE 15-7S-1E and you assumed the responsibility for the well.

Regarding the reserve mud pit used in connection with said well, you have informed us that you wish to use it for a reservoir and will take it over, relieving us of any further clean up work or concern about surface damages of any kind arising out of the drilling of the well mentioned above.

If you agree with the foregoing, please sign in the space provided below and return one copy of this letter to us in the enclosed self-addressed envelope.

Very truly yours,

THE SUPERIOR OIL COMPANY

R. S. Troost
District Landman

RST/b
enc.

ACCEPTED AND AGREED TO
THIS 23 DAY OF Sept., 1966.

FRANCIS A. PETERSON



POWERTECH (USA) INC.
HYDRO ILLU *



SEP 13 47 of 63
1966

SCIENCE CENTER, UNIVERSITY OF SOUTH DAKOTA CAMPUS,
VERMILLION, 57069, PHONE 624-4471

WESTERN FIELD OFFICE, 208 GAY BUILDING, BELLE FOURCHE,
BOX 187, 57717, PHONE 892-3121



Western Field Office
September 12, 1966

Mr. Robert Schoon
Geologist
State Geological Survey
Vermillion, South Dakota

Dear Bob:

Would you check the file on the Superior #1 Peterson, in
Fall River County, and see if Superior has sent us a copy of
the RELEASE, signed by the land owner.

Sincerely,

Earl Cox
Engineering-Petroleum Geologist

EC:rk

*P.S. Also have you need sample from the
Tenneco #1 - Montrose, Fall River County*

DUNCAN J. MCGREGOR
DIRECTOR AND STATE GEOLOGIST
VERMILLION

MERLIN J. TIPTON
ASSISTANT STATE GEOLOGIST
VERMILLION

EARL J. COX
SENIOR GEOLOGIST
BELLE FOURCHE



POWERTECH (USA) INC.

Hydro ID 4

48 of 63

NOV 1 1965

Western Field Office
October 29, 1965

Mr. J. P. Dujke
Superior Oil Company
P. O. Box 200
Casper, Wyoming

Re: Superior #1 Peterson (44-15)
SESE-15-7S-1E
Fall River County, So. Dakota
Permit No. 382

Dear Mr. Dujke:

Thank you for your October 27 letter. A release from Mr. Peterson will meet all requirements covering cleaning up of the above location. If a copy of the release is sent to me, it will expedite bond termination.

Sincerely,

Earl Cox
Engineering-Petroleum Geologist

EC:sm



09/10/65

Western Field Office
October 7, 1965

Mr. J. P. Dujka
Superior Oil Company
P. O. Box 200
Casper, Wyoming

Re: Superior #1 Peterson (44-15)
SESE-15-75-1E
Fall River County, So. Dakota
Permit No. 382

Dear Mr. Dujka:

I visited the above location September 2 and found that the wellhead valve was open and water was running into the mud pit.

As you plan to fill the pit after it dries up, you may wish to contact the landowner and have him either close the valve or divert the water so it will not enter the pit.

Sincerely,

Earl Cox
Engineering-Petroleum Geologist

EC:an



July 13, 1965

**Mr. Earl Cox
State Geological Survey
P. O. Box 187
Belle Fourche, South Dakota 57717**

Dear Earl:

I am enclosing the electric log and dual induction laterolog on the Superior Peterson #1 (44-15) well in Fall River County, and carbon copies of the scout reports that Bob Schoon turned in last week.

Sincerely yours,

**Janet J. McDonough
Senior Stenographer**

Enclosures



MAY 13 1965

SOUTH DAKOTA

State Water Resources Commission

STATE OFFICE BUILDING

PIERRE, SOUTH DAKOTA

May 12, 1965

Mr. Francis A. Peterson
Edmonton, South Dakota 57736

Re: Superior #1 Peterson (48-15)
SE $\frac{1}{4}$ SE $\frac{1}{2}$ 15-76-1E
Fall River County, S.D.
Permit No. 394

Dear Mr. Peterson:

In as much as the requirements for converting your oil test well to a water well have been done, as specified by the State Geological Survey, the Water Resources Commission hereby assumes jurisdiction of the well as a water well.

Sincerely,

J.W. SIMMS

JGC/BM/dw

cc: ✓ Dr. Duncan McGregor, State Geologist, Watrillon, S.D.
Mr. Earl Cox, Belle Fourche, S.D.
Oil and Gas Board, Pierre, S.D.



MAY 11 1965

Western Field Office
Belle Fourche, South Dakota
May 10, 1965

Mr. Joe Grimes
Water Resources Commission
State Office Building
Pierre, South Dakota

Re: Superior #1 Peterson (44-15)
SE SE-15-78-1E
Fall River County, South Dakota
Permit No. 382

Dear Mr. Grimes:

The above oil test is on land owned by Francis A. Peterson. He made arrangements to convert the test to a water well. The well has 971 feet of 8 5/8 inch surface casing, cemented with 575 sacks of cement. The base of the casing is just above the lowest Sundance sand. Immediately below the sand is a cement plug. Additional plugs were placed so as to isolate the Minnelusa sands in the hole. A three inch control valve is in place on the wellhead and when last visited, the well was flowing about 10 gpm of fresh water.

Enclosed is a letter from Mr. Peterson asking that conversion of the oil test to a water well be approved. Peterson agrees to assume full liability for any subsequent plugging that might be required.

If the Water Resources Commission will accept jurisdiction of this test as a water well, please so inform the Oil and Gas Board with a copy of your letter to the State Geologist.

Sincerely,

Earl Cox
Engineering-Petroleum Geologist

EC:sn

cc: Secretary, Oil and Gas Board w/enc.
State Geologist w/enc.

F.S. to Duncan: Even though the Water Resources Commission accepts jurisdiction the pits have not been filled at this location and it is suggested that we not approve the bond release until they have been filled. Earl



Hydro ID 4

MAY 10 1965
53 of 63

THE SUPERIOR OIL COMPANY

SUPERIOR BUILDING
P. O. BOX 200
CASPER, WYOMING 82602

May 7, 1965

State Geological Survey
Science Center
University of South Dakota Campus
Vermillion, South Dakota

Re: Peterson #1 (44-15)
C SE SE 15-7S-1E
Fall River County
South Dakota
Permit #382

Gentlemen:

Attached are two copies each of the core and sample description on the above test.

Today we received a copy of the transmittal letter from American Stratigraphic Company showing they have sent you the samples for this well. As stated on the plugging record, the mud pits have been fenced and will be filled and leveled when they dry up.

If you need any further information or reports, please let us know.

Yours very truly,

THE SUPERIOR OIL COMPANY

J. P. Dujka

RLH/jr

cc: Mr. Earl Cox
South Dakota State Geological Survey
Western Field Office
Belle Fourche, South Dakota

54 of 63
MAY 7 1965



AMERICAN STRATIGRAPHIC COMPANY

17 NORTH 31ST ST. • BILLINGS, MONTANA • ALPINE 9-7847

May 4, 1965

State of South Dakota Geological Survey
Science Center
Vermillion, South Dakota

Attention: Dr. Duncan McGregor
State Geologist

Gentlemen:

We are shipping you today via motor freight samples on the following well:

✓ Superior, #1 Peterson
15-7S-1E
Fall River County, South Dakota.

Very truly yours,

AMERICAN STRATIGRAPHIC COMPANY

Fred McCotter
Fred McCotter *bc*
Manager

FMc/be

cc: Mr. Jerry Davis, Superior Oil Company, Box 200, Casper, Wyoming.



SOUTH DAKOTA
STATE GEOLOGICAL SURVEY
SCIENCE CENTER

University of South Dakota Campus
VERMILLION 57068
Phone 624-4471

Western Field Office
Belle Fourche, South Dakota
April 15, 1965

DUNCAN J. MCGREGOR
Director and State Geologist
MERLIN J. TIPTON
Assistant State Geologist

Mr. J. P. Dujka
Superior Oil Company
P.O. Box 200
Casper, Wyoming

Re: Superior #1 Petersen (44-15)
SEK-15-75-1E
Fall River County, So. Dakota
Permit No. 382

Dear Mr. Dujka:

In checking our files, at Vermillion, I find we still need two copies each of the core and sample description on the above test. These records should be sent in within thirty days of completion of the test.

Before the bond can be released, the rig must be removed from the location, the samples sent in and the mud pits either filled or a release obtained from Mr. Peterson.

This letter is merely to inform you of the status of our files and to outline our requirements. It is hoped Superior will see fit to do additional work in South Dakota and be assured of our future cooperation.

Sincerely,

Earl Cox
Engineering-Petroleum Geologist

EC:sn



Edgemont, South Dakota
March 10, 1965

Mr. Joe Grimes
Water Resource Commission
Pierre, South Dakota

Re: Superior #1 Peterson(44-15)
SEKSEK-15-7S-1E
Fall River County, So. Dakota
Permit No. 382

Dear Mr. Grimes:

I wish to convert the above oil test, on my land, to a water well. The water to be used will come from the sand zone immediately below the surface casing. A cement plug is in place, immediately below the water zone. The lower portion of the hole has been plugged according to specifications of the State Geological Survey.

Should conversion of the oil test to a water well be approved, I agree to assume full liability for any subsequent plugging that might be required.

Sincerely,

Francis A. Peterson

Hydro ID 4



SOUTH DAKOTA
STATE GEOLOGICAL SURVEY
SCIENCE CENTER

University of South Dakota Campus
VERMILLION 57069
Phone 624-4471

Western Field Office
Belle Fourche, South Dakota
March 9, 1965

MAR 10 1965

DUNCAN J. McGREGOR
Director and State Geologist

MERLIN J. TIPTON
Assistant State Geologist

Mr. Francis A. Peterson
Edgemont, South Dakota

Re: Superior #1 Peterson(44-15)
SE~~4~~SE~~4~~-15-7S-1E
Fall River County, So. Dakota
Permit No. 382

Dear Mr. Peterson:

Enclosed is a letter and three copies made out to Mr. Grimes, of the Water Resource Commission, stating you wish to convert the above oil test to a water well. Please sign the original and all copies, and return to me in the stamped, addressed envelope.

As soon as you get the valve in place, at the wellhead, please let me know so it can be inspected. An envelope is enclosed for your use.

Sincerely,

Earl Cox
Engineering-Petroleum Geologist

EC:sn



Edgemont, South Dakota
March 4, 1965

Dr. Duncan McGregor
State Geologist
State Geological Survey
Vermillion, South Dakota

Re: Superior #1 Peterson (44-15)
SE $\frac{1}{4}$ SE $\frac{1}{4}$ -15-7S-1E
Fall River County, So. Dak.
Permit No. 382

Dear Sir:

The above oil test on my land is to be plugged and abandoned. It is requested that the test be plugged in a manner so that I can easily go back into it at a future date and perforate the casing and tap the artesian water flow that is behind the casing.

To be specific, it is requested that approval be granted to weld or screw a cap on the top of the surface casing in place of the abandonment marker. It is also requested that the ten sack surface plug not be placed.

Should the test be plugged in the above manner, I agree to assume full liability for any subsequent plugging that might be required.

Sincerely,

F. A. Peterson



FEB 24 1965

SOUTH DAKOTA

State Water Resources Commission

STATE OFFICE BUILDING

PIERRE, SOUTH DAKOTA

February 23, 1965

**Mr. F. A. Peterson
Edgemont, South Dakota**

Dear Mr. Peterson:

I have been advised that the Superior Oil Company has obtained a Permit to Drill for Oil and Gas on your land in Section 15, T 7 S, R 1 E.

Occasionally, owners of land consider converting abandoned oil wells into water wells. Please advise me whether or not you intend to convert the oil well drill hole on your land into a water well if water is encountered and the drill hole is abandoned as an oil well.

If you are considering making a water well out of the abandoned oil well drill hole, special considerations are necessary to comply with the State's oil and water laws. The abandoned oil hole must be properly plugged and the water well properly constructed. All conversion work will be at your expense. The cost will vary, depending upon the characteristics of the drill hole, but such cost will be in the neighborhood of \$5,000 or more. Usually another driller and drill rig will have to be arranged for. This other drill rig and casing and other materials will have to be on hand to take over immediately after the special oil well plugging is completed, because the drill hole cannot be left open for any appreciable length of time without spoiling it. Approval of plans for construction of the water well will be required, and a bond covering proper construction may be required. Also, a water right may be required. All of these arrangements take considerable time to accomplish.

Please advise me immediately if you plan to convert the oil well drill hole into a water well. We both hope that a producing oil well results from the drill hole on your land; however, if not and you are planning on a water well, we must start making arrangements now.

Sincerely,

J.W. GRIMES
Chief Engineer

JHG/BN
Oil & Gas Board, State Capitol, Pierre, S.D.
Dr. Duncan McGregor, State Geologist, University of S.D. ✓
Vermillion, South Dakota

SURETY

**NO SURETY INFORMATION FOR
THIS WELL AS OF 5/18/2011**

MISCELLANEOUS

2205 Superior Oil Co. #1 Peterson
2264 15-7 S-1 E, Fall River Co.

0 " " "
2205

5/10/65

THE SUPERIOR OIL COMPANY
SUPERIOR BUILDING
P. O. BOX 200
CASPER, WYOMING 82602



Oil and Gas Search for: api_no_like '40 047 20065'		
Page 1 of 1	<input type="button" value="Export Options"/> (temporarily unavailable)	Page: 1

Record 1 of 1

Well Information

API No:	40 047 20065	County:	FALL RIVER
Well Name:	PRC 21-14 PETERSON	Location:	NENW 14-7S-1E
Permit No:	741	Total Depth:	2266
Operator Name:	POWER RESOURCES CORPORATION	Bottom Hole:	Minnelusa
Permit Date:	12-03-1975	KB Elevation:	3647
Spud Date:	12-11-1975	Ground Elevation:	3639
Plug Date:	12-26-1975	Latitude:	43.447765
		Longitude:	-103.968121
Well Field	WILDCAT	Status	P&A
Class:	DRY HOLE	Type:	DRY HOLE

Formation Tops

<u>Formation</u>	<u>Depth (ft.)</u>
Morrison	322
Spearfish	890
Goose Egg	1178
Minnekahta	1425
Opeche	1465
Minnelusa	1569
Red Marker	1984
2nd Leo	2100

Page 1 of 1 (goto top)	Page: 1
--	----------------

COUNTY: FALL RIVER
LEGAL LOCATION: NENW 14-7N-1E
API NO: 40 047 20065
PERMIT NO: 741
WELL NAME: PRC #21-14 PETERSON
OPERATOR: POWER RESOURCES CORPORATION
PERMIT ISSUED: 12/03/1975
PERMIT CLOSED: 01/23/1976
FILE LOCATION: 7N-1E-14 NENW

TARGET CODES:

WELL HISTORY / CHECKLIST

PERMIT TO DRILL / INTENT TO DRILL

WELL INSPECTION / SCOUT REPORTS

OPERATOR'S TECHNICAL REPORTS / MAPS

ADMINISTRATIVE / SUNDRY REPORTS

CORRESPONDENCE

SURETY

MISCELLANEOUS



WELL HISTORY / CHECKLIST

BOND RELEASE CHECKLIST

Wall Name & Location		Permit # 741
PRC #21-14 Peterson NENW 14-7S-1E, Fall River County		API #40 047 20065
Bond # 4288541	Date Issued Dec. 3, 1975	Date released Aug. 25, 1976

Surface Restoration

- Pits filled
- Site level
- Site policed
- Dry-hole marker solid, sealed, correctly inscribed
- No dry-hole marker desired, letter in WFO files from surface owner
- (Converted to water well, owner's responsibility) *FK*

Paperwork Filed

- Form 4 (Completion or Recompletion Report)
- Form 6 (Sundry Notices and Report on Walls)
- Form 7 (plugging Report)

Geological Information Filed

- Wall Logs: IES, SNP, (DIL), GR, NEUT, CALIP, Cement Bond, Temp, Micro, Laterlog, SM Dens. *BCSL*
- DST charts and reports
- Geologist's Report
- Results of coring and core analyses
- Set of 10-foot sample cuttings (check with Bob Schoon)

have been received at Vermillion 1-15-76 Jua

DATE 8-25-76 CHECKED BY Jua



PERMIT CHECKLIST

Well Name and Location:	Permit # <u>741</u>
PRC #21-14 Peterson NENW 14-7S-1E, Fall River	API # <u>10 047 20065</u>
	Bond # <u>4288541</u>

Paperwork Filed with WFO

- Organization Report
- Application
- Bond
- Permit fee

The Following Papers sent to Operator:

- Permit (Form 2a)
- Receipt for \$100 permit fee
- Cover letter explaining material sent

Permit Fee Filed:

- Permit fee w/Cash Receipts Transmittal Form sent to State Treasurer

Notification of New Permit sent to:

- Dr. Duncan J. McGregor
- Mr. Vern W. Butler
- Dr. Allyn Lockner
- Mr. George Kane

DATE Dec. 3, 1975 CHECKED BY Jan Miller

PERMIT TO DRILL / INTENT TO DRILL



State Pub. Co., Pierre

APPLICATION FOR PERMIT TO:

S. Dak. Oil & Gas Board FORM 2

DRILL DEEPEN PLUG BACK
 OIL WELL GAS WELL SINGLE ZONE
 MULTIPLE ZONE

FARM OR LEASE NAME
M. Lenora Peterson
 WELL NO.
~~12-14~~ # *21-14*
 FIELD AND POOL OR WILDCAT
Wildcat
 NO. ACRES IN LEASE
971.32
 SEC TWP RGE
NENN 14-75-1E
 COUNTY
FULL RIVER

OPERATOR
Powee Resources Corporation
 ADDRESS
1660 S. Albion St Suite 827 Denver, Colorado 80222
 LOCATION In feet from an established corner of the legal subdivision:
660 ft. NORTH
1983 ft. West
Section 14-75-1E

NAME AND ADDRESS OF SURFACE OWNER
M. Lenora Peterson
State Route, Edgemont, So. Dakota 57735
 ELEVATION
3639 GR
 PROPOSED DEPTH
2500
 NAME AND ADDRESS OF CONTRACTOR
E. Aensworth and Kaiser
P.O. Box 940
Newcastle, Wyoming

NO. OF WELLS ETC.
NONE
 ROTARY OR CABLE TOOLS
Rotary
 APPROXIMATE DATE WORK WILL START
December 3, 1975

IF LEASE PURCHASED WITH ANY WELLS DRILLED, FROM WHOM PURCHASED (Name and address)
- NO -

PROPOSED CASING AND CEMENTING PROGRAM					
SIZE OF HOLE	SIZE OF CASING	WEIGHT PER FOOT	NEW OR SECOND HAND	DEPTH	SACKS OF CEMENT
<i>12 1/8"</i>	<i>8 7/8"</i>	<i>28</i>	<i>Second hand</i>	<i>150</i>	<i>150</i>

DESCRIBE PROPOSED OPERATIONS IF PROPOSAL IS TO DEEPEN OR PLUG BACK. GIVE DATA ON PRESENT PRODUCTIVE ZONE AND PROPOSED NEW PRODUCTIVE ZONE. GIVE BLOW OUT PREVENTER PROGRAM IF ANY

Drill a 7 1/8" hole from bottom of surface casing to estimated total depth of 2500. Will test the Leo zones of Minnelusa formation. Drill stem test any zones with shows of oil & gas. If commercial production indicated will set 5 1/2" casing 100 feet below prospective pay zone, permeate, and complete.

SIGNED *Richard L. Samham* TITLE *Vice President-Land* DATE *NOV. 28 1975*

WRITE BELOW THIS LINE

APPROVED BY *John W. Steice* Supervisor

DATE *December 3, 1975*

CONDITIONS
 COMPLETE SET OF SAMPLES, AND CORES IF TAKEN, MUST BE SUBMITTED.
 SAMPLES, AND CORES IF TAKEN, BELOW DEPTH, MUST BE SUBMITTED.

STATE GEOLOGICAL SURVEY
 WESTERN FIELD OFFICE



INSTRUCTIONS

General: This form is designed for submitting proposals to perform certain well operations, as indicated, on all types of lands and leases for appropriate action by either a Federal or a State agency, or both, pursuant to applicable Federal and/or State laws and regulations. Consult applicable Federal or State regulations, or appropriate officials, concerning approval of the proposal before operations are started.

If the proposal is to re-drill to the same reservoir at a different subsurface location or to a new reservoir, use Form 2 with appropriate notations.

If the well is to be, or has been, directionally drilled, so state and show by attached sheets, if necessary, the coordinate location of the hole in any present or objective productive zones.

(*Sample location: 600' South and 600' East of the Northwest Corner of Section 16.)



R. 1 E

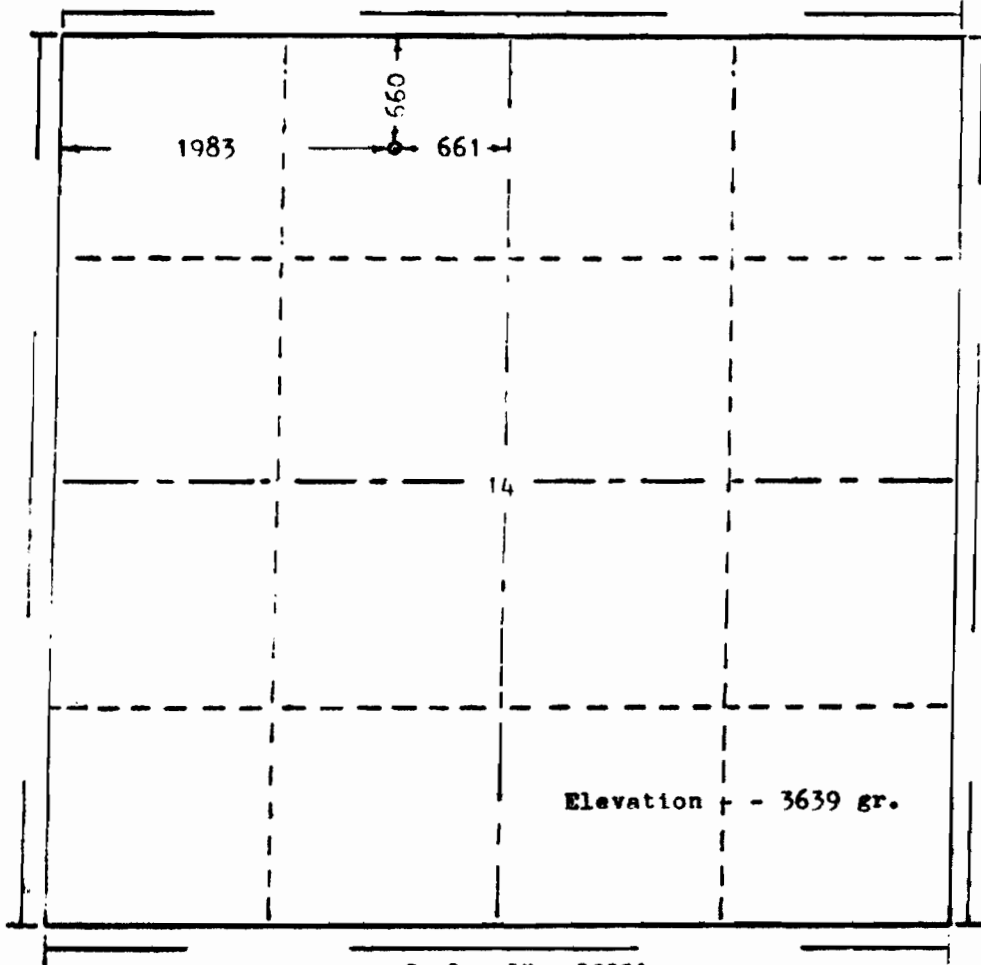

T.
7
S

Scale: 1" = 1000'

#21-14
Jus

Thomas E. Nelson, of Casper, Wyoming
 has in accordance with a request from Mr. Bessham
 for Power Resources Corporation
 determined the location of #12-14 M. Lenore Peterson
 to be C NE NW Section 14, Township 7 South
 Range 1 East of the Black Hills Meridian
 Fall River County, South Dakota

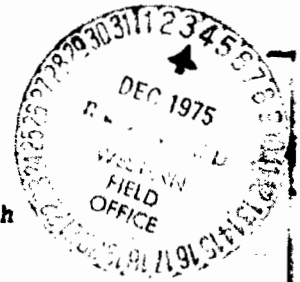

I hereby certify that this plat is an
 accurate representation of a correct
 survey showing the location of
 #12-14 M. Lenore Peterson

Date: 11-29-75

#21-14
Jus

T. Nelson
 Licensed Land Surveyor No. 1200
 State of South Dakota



ORGANIZATION REPORT

Full Name of the Company, Organization, or Individual Power Resources Corporation
Post Office Address (Box or Street Address) 1660 S. Alhion St. Suite 827, Denver Colo. 80222
Plan of Organization (State whether organization is a corporation, joint stock association, firm or partnership, or individual) Corporation

If a reorganization, give name and address of previous organization
NONE

(1) If foreign corporation, give State where incorporated WYOMING
(2) Name and postoffice address of State agent OT Corporation System
319 S. Coteau St.
Pierre, S. Dakota 57501
(3) Date of permit to do business in state December 1995

Principal Officers or Partners (if partnership) NAME	TITLE	POSTOFFICE ADDRESS
<u>Robert V. Bailey</u>	<u>President</u>	<u>1660 S. Alhion Suite 827 Denver Colo 80222</u>
<u>Milton O. Childers</u>	<u>Executive Vice President</u>	<u>" " "</u>
<u>Richard A. Bassham</u>	<u>Vice President - Land</u>	<u>" " "</u>
<u>John F. Trotter</u>	<u>Secretary - Treasurer</u>	<u>307 Conroy Rd Casper, WY 82401</u>

DIRECTOR'S NAME	POSTOFFICE ADDRESS
<u>Robert V. Bailey</u>	<u>1660 S. Alhion Suite 827 Denver, Colorado</u>
<u>Milton O. Childers</u>	<u>" " " " "</u>
<u>Richard A. Bassham</u>	<u>" " " " "</u>
<u>John F. Trotter</u>	<u>307 Conroy Rd Casper, WY 82401</u>
<u>Clovis E. Radelander</u>	<u>152 N. Durbin " "</u>

Executed this the 28 day of November 1975
State of WYOMING
County of NATRONA

Richard A. Bassham
Signature of Officer

Before me, the undersigned authority, on this day personally appeared Richard A. Bassham, known to me to be the person whose name is subscribed to the above instrument, who being by me duly sworn on oath states, that he is duly authorized to make the above report, and that he has knowledge of the facts stated herein, and that said report is true and correct.

Subscribed and sworn to before me this 28 day of November 1975
SEAL: County of Natrona State of Wyoming
My commission expires June 28, 1978

Richard A. Bassham
Notary Public in and for Natrona County, Wyoming

DO NOT WRITE BELOW THIS LINE
Approved 12-3-75 Date
Oil and Gas Board of the State of South Dakota
Fred V. Steece
Superintendent WFO





WELL INSPECTION / SCOUT REPORTS

SOUTH DAKOTA GEOLOGICAL SURVEY
Western Field Office
SCOUT REPORT

Number 2

Date Scouted 7-27-76

Operator Power Resources Corporation

Permit Number 741

Farm/Lease Name #21-14 Peterson

API Number 40 047 20065

NENW Sec. 14 T. 7S R. 1E

County Fall River

Elev. 3639 Est. T.D. -

Actual T.D. 2284 Spudded 12-11-75

Contractor Farnsworth & Kaiser

Geologist Al Nelson

SCOUT'S OBSERVATION:

DST RECORD:

Open pipe at surface with mud
all around it remains at site.
Bags of cement and other refuse strewn
about. No indication of completion as
water well.

FORMATION TOPS:

PLUGGING RECORD:

DATE PLUGGED/COMPLETED _____

CASING RECORD:

SITE INSPECTION:

_____ From _____ To _____

Approved X

_____ From _____ To _____

Not Approved _____

REMARKS: No open mud pits. Water well piping is probably subsurface. Mess
probably belongs to the rancher.

SCOUTED BY James E. Ellithorpe
James E. Ellithorpe, Field Assistant

Fred V. Steece
Fred V. Steece, Supervisor



J PRC #21-14 Peterson
NENW14-7S-1E Fall River
660FNL & 1983FWL

12-26-75

Al Nelson called
for plugging approval
we worked out follow-
ing plug program

PERMIT: 741 (12-3-75)

API: 40 047 20065

ELEV: 3639 Gr.

CONTR: Farmworth & Kaiser ^{Nelson}

GEOL: Al Nelson

ENGR:

SPUD: 12-11-75

EST T.D. 2500 (Leo)

CASING: 8 5/8 - 160 (@ 152)

CORES: None

DSTS: None

LOGS: BCSL, DIL

T.D.: 2269 (DIL) 2267 (Log)

PLUG: 12-26-75

40 max: 2020-1900 ^{Red} marker
40 max: 1600-1500 ^{Top} ml
30 max: 950-850 ^{Basal} Sandance
no surface plug
as well will be
completed as a
water well.

Formation Tops (Nelson)

Fuson	178
Worison	339
Sundance	571
Basal Sd	862

J Power Resources Corp, Denver
John Trotter & George Wolf, principals

Specific	877
Brown Egg	1180
Muirfield	1428
Muirfield	1571
1st Conr	1571
Amey	1648
2d Conr	1696
2d Marker	1988
2d Leo	2099
TD	2269

7-27-76
Visited site to see if
converted to water well
responsible to fill,
site is a mess.

OPERATOR'S TECHNICAL REPORTS / MAPS



Hydro ID 5

14 of 44 - 7/1

G. ALLAN NELSON
CONSULTING PETROLEUM GEOLOGIST
ROOM 408, MAJESTIC BUILDING
(303) 623-7750 REG 322-0325
DENVER, COLORADO 80202



GEOLOGICAL WELL REPORT

POWER RESOURCES CORPORATION

#21-14 LENORE PETERSON

NE NW SEC. 14, T.7S., R.1E.,

FALL RIVER COUNTY, SOUTH DAKOTA

Wildcat

WELL DATA

Location: 1983' from the West line and 660' from the North line, G NE NW Sec. 14, Township 7 South, Range 1 East, Fall River County, South Dakota.

Elevation: 3639 ground.
3647 K.B.

Type Well: Wildcat.

Spud Date: 10:00 P.M., December 11, 1975.

Completion Date: 9:00 P.M., December 26, 1975.

Casing Record: Ran 8 5/8" surface casing. Set at 152' ground. Cemented with 125 sacks of regular cement with 3% Calcium chloride. Pipe set at 152' ground. 24# casing.

Total Depth: 2269 Driller.
2267 Schlumberger.

Deepest Formation Penetrated: Lower Leo Section.

Depth Datum: 3647 K.B.

Well Status: Plugged and abandoned (left as water well for landowner).

Mud Program: Drilled out from under surface with water. Continued drilling with native mud down to 1070 in Spearfish red beds. Converted to a red bed between 1070 and 1283 in the Goose Egg formation after getting stuck at 1283. Added 1 sack of soda ash, 5 Rayvan, 4 caustic soda, 1 can suf-drill, and 25 sacks of gel. Above 1283 a water-flow was continually thinning mud, particularly when mud pump was shut down on trips for bit.

Between 1625 in the Converse Massive Anhydrite and 1729 in middle Converse tourly treatment was Gel, 1 sack caustic soda, 1 soda ash, 1 Rayvan, and mud weight was 9.4-9.6 Mnd vis. was 36 to 37. At 2045 to 2078 in upper Leo wt. was 9.7 and vis. was 46, with tourly treatments of 1 sack of soda ash, 1 Rayvan, 1 caustic soda, and 4 CMG to get water loss down to 5 cc. or less before Second Leo was reached at approximately 2100.

At 2105 in Second Leo Sand main objective wt. was 10.0, vis. 36, and water loss 6.0. Water flow from up the hole continued to create problems in maintain-good quality mud.

Logs were run without any hole trouble. Wt. was 10.3, vis. 85, and water loss 7.2.

Mud furnished by Pro-Mud, Casper; Phil Hogan, engineer.



WELL DATA (Con.)

Hole Size: 12 1/4" from surface to 168.
7 7/8" from 168 to 2269 T.D. Driller.

Cores: (None).

Drill-Stem Tests: (None).

Logs: Schlumberger Borehole Compensated Sonic Log was run from T.D. up to base of surface casing on a 5" scale 40-70-100, and on a 5" scale 40-90-140 from T.D. up to 1400 above Minnekanta. Gamma Ray Log and Caliper Log were also run with Sonic Log. Two repeats were run from T.D. up to 1980 first and then from T.D. up to 1400 on a 40-90-140 scale. Dual Induction Laterolog was run second and did not work. 8 hours were spent waiting for a second tool to arrive. A 2" scale was run from T.D. to base of surface pipe, and a 5" scale over same interval was also run, with a repeat from T.D. up to 1900.
Engineer: Don Marquez, Gillette.

Plugging Record: 40 sacks from 2020 to 1900 across the Red Marker.
30 sacks from 1600 to 1500 across top of the First Converse Sand.
30 sacks from 950 to 850 across Basal Sand of the Sundance.
Cementing by Haloo, Gillette
(No plug-in surface pipe since left as water well).

Contractor and Rig Equipment: Farnsworth & Kaiser, Newcastle, Wyoming.
U-34 rig.
3 1/2" IF drill pipe.
5 1/2" drill collars totaling 341'.
Mud pump GD FXQ with 6" liners and 16" stroke.
Radios on rig and at Newcastle base plus in pusher's pickup.
Mud pump trailer-mounted.
Rig trailer-mounted.
Buzz Farnsworth, pusher-owner.

Sample Storage: One out of samples were sent to American Stratigraphic in Casper, sent
One out of samples were to the South Dakota Geologic Survey in Vermillion.

Drilling Time Records: Original copy of Star Recording 1' drilling time charts is on file in Denver office of G.A. Nelson.



LOG FORMATION TOPS

All depths are measured from 3647 K.B.

<u>FORMATION</u>	<u>DEPTH</u>	<u>DATUM</u>
LOWER CRETACEOUS		(In first samples at 184 K.B.)
TENTATIVE FUSON SHALE (LAKOTA TOP INDETERMINATE)	178	
UPPER JURASSIC	339	
MORRISON FORMATION	339	
SUNDANCE FORMATION	571	
REDWATER SHALE MEMBER	571	
LAK MEMBER	690	
TENTATIVE HULETT SAND	795	
STOCKADE BEAVER SHALE	817	
BASAL SAND OF SUNDANCE	862	
TRIASSIC	877	
SPEARFISH FORMATION	877	
PERMIAN	1180	
GOOSE EGG FORMATION	1180	
FORKLE LIME MEMBER	1320	
GLENDO SHALE MEMBER	1338	
MINNEKAHTA LIME MEMBER	1428	
OPEOHE SHALE MEMBER	1471	
MINNELUSA FORMATION	1571	-2076
UPPER MINNELUSA (PERMIAN)	1571	-2076
FIRST CONVERSE SAND	1571	-2076
BASE OF SAND	1648	
MASSIVE ANHYDRITE	1648	
BASE OF ANHYDRITE	1696	
SECOND CONVERSE SAND	1696	
BASE OF SECOND CONVERSE SAND	1722	
RED MARKER	1988	-1659
BASE OF RED MARKER	1992	



LOG FORMATION TOPS

<u>FORMATION</u>	<u>DEPTH</u>	<u>DATUM</u>
PENNSYLVANIAN	1992	-1663
MIDDLE MINNELUSA (LEO SECTION)	1992	-1663
SECOND LEO BAND	2099	-1548
BASE OF SAND	2130	
TOTAL DEPTH DRILLER (STRAP)	2269	
TOTAL DEPTH SCHLUMBERGER	2267	



SAMPLE LITHOLOGIC DESCRIPTION

All depths are from 3647 K.B.

All sample depths following have been corrected for lag, and then matched to drilling time breaks wherever possible. **Sample lithology is then matched to log lithology so that all lithology following matches log.

All shows are underlined with a solid line. Possible shows are underlined with a dashed line.

DEPTH

LITHOLOGY

<u>LOWER CRETACEOUS</u>	(In first samples caught below surface pipe at 184 K.B.)
<u>TENTATIVE FUSON</u>	178 (LAKOTA TOP INDETERMINATE) (In first samples caught below surface pipe at 184 K.B.)

(Samples following are caught at 10" intervals)

<u>184-86</u>	Abundant variegated clay, red, maroon, dark gray, purple, light green; limited sand, white, no show, no porosity, very well-cemented, very fine to fine, limy, poorly sorted, slightly soft, abundant white clay-fill.
<u>186-97</u>	Same variegated clay; very shaly sand, very silty, very fine, abundant clay cementation, part very fine to fine with poor sorting, no porosity, very soft.
<u>197-204</u>	Same red, maroon, purple waxy clay, also light green, noticeable brownish gray; purple very sandy clay; limited very shaly sand as above.
<u>204-10</u>	(Very fast drilling) Traces pale green sand with abundant waxy clay cementation, very fine, silty, very soft, no show, also white.
<u>210-30</u>	Same as above (fast drilling).
<u>230-34</u>	(Very slow drilling like hard formation) Trace tannish brown very shaly sand, hard, tight, very fine, excellent sorting, no porosity, noncalcareous.
<u>234-41</u>	(Fast drilling) Waxy clay, red, maroon, violet, tan, pale green.
<u>241-52</u>	Same clay, also distinctive very dark chocolate brown; loose sand grains, poorly sorted very fine to fine to medium, subround.
<u>252-59</u>	Same red, violet waxy clay, some dark gray; same loose sand grains, clear, poorly sorted.
<u>259-70</u>	Same clay; traces green shaly sand, very fine to fine, very soft, silty, trace angular med grained orange quartz grain.
<u>270-88</u>	Same clay; abundant light red very shaly sand, waxy clay cementation, very fine, very soft; first trace chert, whitish, light gray, very coarse and coarser, subangular. (Top 12' very, very fast drilling like high porosity) Purplish maroon waxy shale, clay, light to dark gray; abundant very shaly sand, light red, very silty, clay cementation, very fine, soft.



SAMPLE LITHOLOGIC DESCRIPTION (Con.)

- 288-99 (Top 6' very fast drilling) Same as above.
- 299-311 (Basal 4' hard drilling) Shaly sand, dark green, very hard and tight, very well-cemented, no porosity, ver fine, well-sorted.
- 311-18 Abundant clay-filled sand, light red, very fine, silty, mushy soft; shale breaks, waxy clay, light green, red.
- 318-39 Same; green sand, shaly, very fine to fine, tight, no porosity.
- 539 MORRISON 339-50 Abundant dark gray silty shale, shale, slightly waxy in part.
- 350-61 Same blackish shale, clay; loose calcite like from veinlet, white, gray, dark gray, in abundance.
- 361-66 Same shale.
- 366-78 Same shale, also dark green waxy, few streaks quartzitic sand, shaly, dark green, hard, very well-cemented, very fine, soft in part.
- 378-92 Increasing greenish dark gray shale, clay, also very dark gray.
Clay, slightly waxy, very dark gray to greenish dark gray, soft.
- 392-? Same waxy clay, grayish green to greenish dark gray, traces red.
- ?-414 Same, also very dark gray clay; intermingled with sandy lime stringer(s), white to gray (Very slow drilling in basal part like lime).
- 414-19 Same clay, very dark gray to greenish dark gray.
- 419-28 (Fast drilling) Waxy clay, dark gray, greenish gray, soft, grayish green.
- 428-34 Waxy clay, mostly grayish green, very soft.
- 434-44 (Very fast drilling) Same.
- 444-59 Same, also dark gray.
- 459-69 Waxy clay, dark gray to greenish dark gray.
- 469-79 Same, with trace white kaolinitic sand, very soft, very fine, no show, excellent sorting.

571 SUNDANCE FORMATION

- 571 REDWATER SHALE MEMBER
- 699 LAK MEMBER

- 699 699-710 Waxy clay, grayish green to greenish gray, dark gray, platy, very soft; sand streaks, greenish light gray, very silty, very, very fine, very soft, poor porosity, scattered fine glauconite.
- 710-16 Same clay and sand; also light tan sand, very fine, silty, soft, no show, porous, excellent sorting.
- 716-30 Same gray to green waxy clay, very soft; limited sand, light tan, very fine and finer, soft, porous, excellent sorting; no show.
- 730-37 Very waxy clay, dark gray, greenish gray, grayish green, very soft; same soft tan sand, very fine, silty, no show; limited orange sand, very fine, well-sorted, shaly, soft, no show.



SAMPLE LITHOLOGIC DESCRIPTION (Con.)

795 TENTATIVE HULETT SAND

817 STOCKADE BEAVER SHALE

823-31 Sandstone, greenish white, very fine, excellent sorting, no show, no porosity, fine glauconite scattered, abundant tiny white spots of clay scattered, soft to very soft, also tiny black specks scattered, limy (Hulett cave).

831-46 Shale, silty shale, gray, greenish gray, platy, very soft, also darker gray; sand streaks, same sand as above, no show, part yellow limonite stained (Hulett cave).

846-57 Same soft waxy shale, grayish green to greenish gray; sand streaks, greenish gray, light gray, no show, poor porosity, very well-cemented, silty, very soft, very fine, excellent sorting, fine glauconite, limy.

857-62 Same alternating shale and sand as above, no show.

862 BASAL SAND OF SUNDANCE

862-72 (Very rapid drilling of 7" in 4") Basal sand of Hulett: sandstone, light greenish gray to yellowish greenish gray, no show, very fine, excellent sorting, porous, very soft, fine glauconite and black specks scattered, no fluorescence.

872-77 Dark gray very waxy shale, very soft; trace also black with pyrite spot; trace tannish gray mottled purplish maroon.

877 TRIASSIC

877 SPEARFISH FORMATION

877-99 (Samples up at 900 in less than 22"; red bed top marked by faster drilling from 2 1/4"/ft. above red bed top to 2"/ft. below red bed top) Abundant brick red silty shale, very silty, very soft, fine black biotite specks scattered; limited smooth red shale; trace white medium crystalline to coarsely crystalline anhydrite.



SAMPLE LITHOLOGIC DESCRIPTION (Con.)

- 1528-34 Plain shale to silty shale, brick red, soft in lower part; top 4' anhydrite, white, tan, microcrystalline.
- 1534-44 (Missing).
- 1544-49 Same red silty shale, soft.
- Anhydrite, white, to tan denser to limited orange.
- 1549-56 Silty shale, light red, brick red, soft.
- 1556-71 Same shale.
- 1571(-2076 MINNELOBA FORMATION
- 1571(-2076 UPPER MINNELOBA (PERMIAN)

- 1571-90 (Sample surfacing off bottom at 1590 in more than 15" and less than 45") (Top 10' very fast drilling like high porosity and bottom 5' fast drilling like good porosity) Abundant sandstone, light yellow, pinkish yellow, soft, no show, good visible porosity, poorly sorted very fine to fine to fine-plus, anhydritic-looking, clear grains, subround.
- 1590-93 Anhydrite stringer, white to tan to gray denser, crypto-crystalline.
- 1593-1602 (Fast drilling like very porous sand) Same sand as above, light yellow, pinkish possible from red bed mud contamination, poorly sorted very fine to fine to fine-plus; porous, no show, no fluorescence, friable.
- 1602-07 (Slower drilling like tight or hard streak) Possible anhydrite stringer, tan denser to white.
- 1607-15 (Very fast drilling of 1"/ft. like high porosity) Sandstone, light yellow, fair sorting, very fine to fine, clear grains, soft, good visible porosity, no show, anhydritic-looking, trace limy; trace light red shaly sandstone, very fine to mostly fine, abundant tiny red shale specks.
- 1615-35 Abundant loose sand grains, very poorly sorted, very fine to fine to few medium grains, clear grains, mostly light yellowish to less of light orange coloration (slower drilling like more cemented, less porosity); sand is cave; white anhydrite, finely crystalline.
- Same as above; anhydrite is in top 17' and sand is in bottom 3' of fast drilling.
- 1635-45 (Continued fast drilling) Same loose sand grains as above.
- 1645-48 (Slightly slower drilling like sand is transitional to anhydrite below)
- 1648 BASE OF FIRST CONVERSE SAND
- 1648 MASSIVE ANHYDRITE

- 1648-60 (Slower drilling 11"/ft.) Anhydrite, tannish light gray, finely crystalline.
- 1696 BASE OF MASSIVE ANHYDRITE

- 1696 SECOND CONVERSE SAND

- 1696-98 Abundant sandstone, light orange, orange, very fine, good sorting, porous, soft, no show, traces whitish clay-fill scattered, clear grains but light orange, subround.
- 1698-1702 Increasingly abundant light orange sand, no show, soft, porous, very fine, well-sorted, anhydritic cementation.



SAMPLE LITHOLOGIC DESCRIPTION (Con.)

1702-1722 (Below top 3' very fast drilling begins: 1"/ft.)
Same light orange sandstone, very fine to fine, soft,
porous, no show, anhydritic cementation, clear light
orange grains, fair sorting, noncalcareous.

1722 BASE OF SECOND CONVERSE SAND

1806-13 Snow white sand, no show, well-cemented, poor porosity,
very fine to fine, fair sorting, anhydritic-looking
cementation, clear grains, soft to slightly soft, no
fluorescence.

1813-24 Same white sand as above, no show, poor porosity due
to being very well-cemented, abundant white clay-fill,
soft.



SAMPLE LITHOLOGIC DESCRIPTION (Con.)

1988(-165)RED MARKER

1988-92 (At 1990 samples coming off bottom in less than 38") (Red Marker marked by typical faster drilling from 10"/ft. above Marker to 2,4,3"/ft. in it) Abundant shale, shiny, splintery, platy, red, maroon, purplish red, very soft.

1992 BASE OF RED MARKER

1992(-166)PENNSYLVANIAN

1992(-166)MIDDLE MINNELUSA (LEO SECTION)

1992-2002 Abundant dolomite, tan to dark tan, anhydritic dolomite, less of red, lighter tan slightly chalky softer, darker tan and reddenser, harder; associated white anhydrite in 20%.

2002-12 (4' below top is 4' of faster drilling like possible shale break) Abundant silty shale, brick red, orange red, very soft; some dolomite and anhydritic dolomite and white anhydrite, with dolomite becoming violet to tan with purple shale spots in part; sand streaks, white, very well-cemented, no show, limited, no visible porosity, very fine to fine, clear grains, anhydritic cementation, non-calcareous, soft, possibly a granular anhydrite. Fast drilling is sd.
2012-22 Dolomite, tan, pink, violet, dense, hard, becoming anhydritic dolomite, tan, finely crystalline; sand streak(s), white, very fine, well-sorted, no show, no porosity, tight, few fine grains, trace mostly fine grained.

2022-32 Very distinctive blackish brown to greenish brown dolomite with tiny blackish spots which in part are embedded clear sand grains, slightly chalky-looking, noncalcareous, hard; 20% finely crystalline snow white anhydrite with dark greenish brown dolomite and tan dense anhydrite.

2032-41 Same dolomite as above, becoming mostly snow white anhydrite with part tan denser and few brown sandy streaks with no porosity, tight.

2041-52 Same as above.

2052-62 Hard snow white to denser gray anhydrite; hard, dense tan to tannish brown to brown mottled red dolomite and anhydritic dolomite, part slightly crystalline; tannish gray very, very finely sandy dolomite, silty, with dark maroon to purplish maroon shaly spots.

2062-71 Anhydritic dolomite, dark tan, dense, very hard, crypto-crystalline, with anhydrite, snow white, very finely crystalline.

2071-84 Dolomite, anhydritic dolomite, tan with purplish tan in part, few purplish red tiny shale spots in part; associated white anhydrite as above; limited violet chalky dolomite.

2084-92 Tan to dark tan anhydritic dolomite, dense, hard, crypto-crystalline, also purplish to maroon shale spots in part; 5% sandstone, light gray to tannish gray, poorly sorted very fine to fine, very well-cemented, no porosity, tight, mostly dolomitic, trace limy, soft to hard, scattered purplish tiny shale spots.



SAMPLE LITHOLOGIC DESCRIPTION (Con.)

- 2092-99 Anhydritic dolomite, tannish brown, very finely sandy, hard, with associated snow white anhydrite, microcrystalline, limited gray denser.
- 2099(-1548) SECOND (Very slow drilling like hard formation)(Drills at 19" LEO SAND to 28"/ft. in sand versus 16"/ft. above and below sand)
- 2099-2113 Abundant sandstone, light gray, very silty, very well-cemented, no show, no visible porosity, tight, poorly sorted, part mostly very fine, part mostly fine with few medium grains, limy to dolomitic; two out of 25 cuttings with traces of yellow fluorescence on each end only, two other cuttings with golden yellow fair fluorescence throughout opposite tan staining in all of of one cutting and tan staining in 50% of other cutting, subround grains, tiny possible oil droplets not detectable after crushing, good yellow fluorescence in 2 stained pieces after crushing.
- 2113-21 Trace first chert in Leo, light gray, translucent, angular, very coarse and coarser; same light gray sand, no show, very silty, very well-cemented, also gray more cemented, mostly very fine, few fine grained streaks, limited same sand grayer slightly quartzitic, no fluorescence.
- 2121-30 Sandstone, very silty, light gray, very fine, excellent sorting, very well-cemented, no show, no porosity, soft, in 40-50%; sandstone, 30-40%, grayish tan staining, very fine to mostly fine, well-cemented, poor or less porosity, soft, noncalcareous; limited gray denser sand, slightly quartzitic, very fine, hard, tight; limited fine to fine-plus sand, white, soft, porous, no show; all with no fluorescence.
- 2130 BASE OF **First jet black coaly shale, coal, mostly brownish black SECOND LEO SAND firm to hard, blocky from 2121 to 2124.
- 2130-42 All tan dense dolomite, anhydritic dolomite, hard, brittle, tile, with few white anhydrite spots and veinlets, cryptocrystalline.
- 2142-52 Same as above but darker brown, greenish brown, dense, cryptocrystalline, with 10% snow white anhydrite; trace round white anhydrite spots in tan dolomite matrix.
- 2152-63 Same dolomite and minor amounts of anhydrite as above; also silty dolomite to lime, greenish tan, soft.
- 2163-69 Silty shale, orange redbrick red, soft; abundant very shaly siltstone, medium gray, no show, no porosity, dolomitic to limy, soft to limited hard; white anhydrite veinlet intersecting siltstone, medium crystalline.
- 2169-82 Second jet black coaly shale, coal, brownish black, firm, slightly soft; silty red shale break(s) as above, soft; mostly dolomite to anhydritic dolomite, tan, gray, dark gray, some brown, mostly dense to cryptocrystalline, anhydrite is from 2171 to 2182.
- 2182-93 Dolomite, anhydritic dolomite, tan, grayish tan, very cherty, dense, cryptocrystalline in part; grading into very sandy dolomite to very dolomitic sand, tan to grayish tan, very poorly sorted very fine to fine to few medium grains, very well-cemented, no porosity.



SAMPLE LITHOLOGIC DESCRIPTION (Con.)

- 2195-2202 Same dolomite and anhydritic dolomite, becoming darker brown cryptocrystalline; also chalky dolomite to lime, cream, light tan grayish, light gray; abundant shale, orange red, silty, soft; minor amount of anhydrite, white to brownish denser; shale probably in faster drilling lower few feet.
- 2202-12 Same dolomite and abundant red shale as above; increasing snow white anhydrite, very finely crystalline; traces quartzitic sand, white to gray where tighter, very fine, excellent sorting, very well-cemented, no porosity, hard, tight.
- 2212-21 Abundant snow white anhydrite, part gray denser; abundant orange red silty shale as above, very soft; minority Dolomite to limestone, grayish tan, cryptocrystalline, hard, brittle, trace dark gray irregular streaks, trace fine pyrite specks.
- 2221-32 20% brick red shale, orange red, soft, silty; very finely sucrosic silty limy dolomite to limestone, tan, grayish tan, tannish gray, hard; minority snow white anhydrite, microcrystalline to gray denser.
- 2132-40 Very finely sucrosic dolomite, dark gray, less of brown; 15% white anhydrite; 5% or less limited streak of sand, white, light gray, gray, quartzitic, very well-cemented, no show, no porosity, tight.
- 2140-54 Sucrosic limestone, dolomitic lime, var, very finely sandy lime, tan, greenish tan; traces anhydritic sand, white, light gray, no show, no porosity, very well-cemented, very fine, well-sorted; 15% white anhydrite.
- 2154-63 Same as above, with limestone, becoming same white sand, very fine, well-sorted, very well-cemented, no show, no porosity, anhydritic-looking.
- 2165- 68+ (Missing because when 45" circulated samples were caught at T.D. no more cuttings were coming since hole was all cleaned out.

2169 TOTAL DEPTH DRILLER(STRAP)

2267 TOTAL DEPTH SCHLUMBERGER



HOLE DEVIATION SURVEYS

Surveys were made using a Sure Shot Model B with a 7° maximum reading.

<u>Depth</u>	<u>Deviation</u>	<u>Formation</u>
160.....	3/4°	-----
268.....	"	Lakota ?
547.....	1/4	Morrison
779.....	1	Sundance LAK member
1283.....	1 1/4	Goose Egg
1526.....	"	Opeche
2162.....	1 3/4.....	Lower Leo

BIT RECORD

12 1/2" bit from surface to 168. All bits below 168 are 7 7/8".

<u>Run No.</u>	<u>Make</u>	<u>Type</u>	<u>From</u>	<u>To</u>	<u>Feet</u>	<u>Hours</u>	<u>Formation @ Base of Run</u>
1	Smith	DTV RR	168	1037	869	28	Spearfish
2	"	DGF	1037	1526	489	24 3/4	Opeche
3	HTG	OSGIG					
		Setip	1526	1655	129	9 1/2	Massive Anhydrite.
4	Smith	V2J	1655	1750	95	12 1/2	Pre-Second Converse.
5	HTG	J22 RR	1750	1974	224	37 1/2	Basalmost Converse.
6	"	J33 RR	1974	2162	188	46	Pre-Second Leo Sand.
7	"	J65 RR	2162	2269 T.D.	17'	---	Lower Leo Section.

DRILLING PROGRESS SUMMARY

Drilling depths as of 8 A.M. each day.

<u>Date</u>	<u>No. of Days</u>	<u>P.D. Depth</u>	<u>Fm. @ P.D.</u>	<u>Footage Drilled Last 24 hours</u>	<u>Status</u>
Dec. 8, 1975	--	---	---	---	Moving.
9	--	---	---	---	Move & rig up.
10	--	---	---	---	Rig up.
11	--	---	---	---	" to drill
					rathole.
15	1	168	-----	168	Work on rig.
16	2	391	Morrison	223	Drilling.
17	3	1038	Spearfish	647	Service rig.
18	4	1437	Minnekahta	399	Check E.O.P.
19	5	1665	Massive Anhydrite	228	Drilling.
20	6	1764	Pre-Second Conv.	99	-----
21	7	1882	Lower Converse	118	Drilling.
22	8	1974	Basal Converse	92	Trip for bit.
23	9	2077	Upper Leo	103	Drilling.
24	10	2162	Pre-Second Leo	85	"
25	11	2210	Lower Leo	48	"
26	12				

Page 13

Respectfully submitted,

B. Allan Nelson

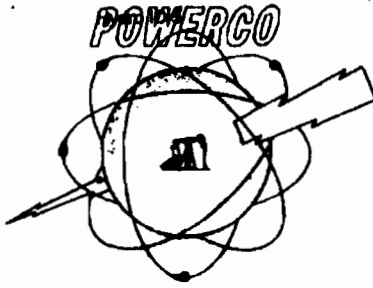

POWER RESOURCES CORPORATION

Power Resources Corporation
#21-14 M. Lenore Peterson
NE 1/4 Sec. 14, T. 7S, R. 1E
Fall River County, S. Dakota
Elevation: Gr. 3639, KB 3647
Well Permit #741

DAILY DRILLING REPORT

- 11/29/75 Surveyed and staked location
- 12/02/75 Graded location and dug pits
- 12/08/75 Moving in rotary tools
- 12/09/75 Moving in and rigging up
- 12/10/75 Finished rigging up
- 12/11/75 Prep to spud
- 12/12/75 Spudded at 10:00 P.M., 12/11/75
Ran 8-5/8" 28# surface casing. Cemented with 125 sacks regular
cement with 3% calcium chloride. Plug down at midnight - good
returns. Pipe set at 152 Gr.
Shut down - waiting on crews.
- 12/16/75 Drilling @ 397'. 3/4° @ 268'.
8 drill collars. Weight on bit - 15,000#. Rotary speed - 100 rpm.
- 12/17/75 1037' - Drilling. 3/4° @ 541', 1° @ 779'.
- 12/18/75 1437' - Drilling. 1 1/4° @ 1002'.
Sample tops: Morrison - 322'
Spearfish - 890'
Goose Egg - 1178'

No shows.
- 12/19/75 1660' - Drilling. 1 1/4° - 1526'. Sample Top: Minnekahta - 1425'
Drilling in 1st Converse sand.
Mud Wt. - 9.4; Visc. - 36.
- 12/20/75 1765' - Drilling
- 12/21/75 1890' - Drilling
- 12/22/75 1974' - Drilling
- 12/23/75 2078' - Drilling



1660 So. Albion, Suite 827, Denver, Colorado 80222 303 759-5660

• 300K 400K 500K 600K 700K 800K 900K 1000K 1100K 1200K 1300K 1400K 1500K 1600K 1700K 1800K 1900K 2000K

ADMINISTRATIVE / SUNDRY REPORTS



STATE AND CO. FORMS

Dak. Oil & Gas Board
FORM 7

PLUGGING RECORD

Operator POWER RESOURCES CORPORATION		Address 1660 So. Albion, Suite 827, Denver, CO 80222		
Name of Lease Lenore Peterson	Well No. 21-14	Field & Reservoir Wildcat		
Location of Well NEMW Sec. 14 - T. 7 S. - R. 1 E.		Sec-Twp-Rgn or Block & Survey	County Fall River	
Applicant to drill this well was filed in name of Power Resources Corporation	Has this well ever produced oil or gas No	Character of well at completion (initial production): Oil (bbls/day) _____ Gas (MCF/day) _____ Dry? Yes		
Date plugged: December 2, 1975	Total depth 2266	Amount well producing when plugged: Oil (bbls/day) None Gas (MCF/day) None Water (bbls/day) None		
Name of each formation containing oil or gas. Indicate which formation open to well-bore at time of plugging	Fluid content of each formation	Depth interval of each formation	Slip, kind & depth of plugs used indicate zones required cemented, giving amount cement.	
Morrison		339		
Basal Sundance Sand		862	950-850 30 Sacks	
First Converse Sand		1571	1650-1500 30 Sacks	
Base 2nd Converse Sand		1722	1900-2020 40 Sacks	
2nd Leo Sand		2099-2113	Traces Yellow Fluorescence	

CASING RECORD

Size pipe	Set in well (ft.)	Failed out (ft.)	Left in well (ft.)	Line depth and method of parting casing (shot, rigged etc)	Packers and shoes
8-5/8	152	0	152		

Was well filled with mud-laden fluid, according to regulations? _____ Indicate deepest formation containing fresh water. _____

In addition to other information required on this form, if this well was plugged back for use as a fresh water well, give all pertinent details of plugging operations to hole of fresh water used, perforated intervals in fresh water sand, name and address of surface owner, and attach letter from surface owner authorizing completion of this well as a water well and agreeing to assume full liability for any subsequent plugging which might be required.

Well plugged back to 850. Land owner, Lenore Peterson, Star Route, Edgemont, So. Dakota, has furnished letter to So. Dakota Geological Survey at Rapid City requesting use of well as a fresh water well. Mr. G. Allen Nelson has presented a detailed Geologic Well Report by letter dated 2 January 1976.

TURN REVERSE SIDE FOR ADDITIONAL DETAILS

Executed this the 12th day of January, 1976
 State of Colorado
 County of Denver

Ed. Bertram, J.P.
 Signature of Notary

I, Ed. Bertram, J.P., known to me to be the person whose name is subscribed to the above instrument, who being by me duly sworn on oath, state that he is duly authorized to make the above report and that he has knowledge of the facts stated therein, and that said report is true and correct.

Subscribed and sworn to before me this 12th day of January, 1976

SKAL
 My Commission expires Sept. 29, 1979

Thomas M. Steece
 Notary Public in and for Colorado
 County Denver, Col.

DO NOT WRITE BELOW THIS LINE

Approved Jan. 23, 1976
 Date

Fred A. Steele
 Supervisor, Western Field Office



CORRESPONDENCE

Peterson and Son, Inc.
Edgemont, South Dakota 57735
April 21, 1976

Mr. Fred Steece
South Dakota Geological Survey
308 West Boulevard
Rapid City, South Dakota 57701

Dear Sir:

I am writing in regard to your letter of February 26, 1976, concerning the well converted to our use. We are using the well as a flowing well to water livestock. The well was completed by adding a 8 5/8 inch pipe to the existing casing and reducing this pipe to 4 inches with a one inch outlet. Approximately 100 feet of plastic pipe carries the water to the tank. We have not had the water analysed.

If you have any further questions, feel free to contact us.

Sincerely,

Debrah Peterson

Debrah Peterson
Secretary



January 7, 1976

Fred Steece
South Dakota Geological Survey
308 West Blvd.
Rapid City, South Dakota 57701



Dear Sir:

I, M. Lenore Peterson, accept full responsibility for the oil test well known as #21-14 Peterson located on my land in ~~NE~~ Section 14 Township 7S. Range 1E. Fall river County, South Dakota as it is being left for a water well. Relieving Power Resources of their responsibilities with their bond.

The top of the highest plug is 850 feet and it has an 8 5/8" casing to 152 feet below ground level.

Sincerely,

M. Lenore Peterson

M. Lenore Peterson

Star Route

Edgemont, S.D. 57735

cc: John Trotter

December 3, 1975

Mr. P. A. Bassham, Vice President
Power Resources Corporation
1660 S. Albion, Suite 827
Denver, Colorado 80222

Dear Mr. Bassham:

Enclosed is your copy of Permit #741 (form 2a) and approved application to drill (form 2) covering the Power Resources Corporation #21-14 Peterson oil test in Fall River County, South Dakota. A copy of the permit should be posted at the well site. Also enclosed is a receipt for your \$100 permit fee. Please make drilling progress reports to the Western Field Office at least weekly.

May I wish you success in your drilling venture and if there is anything I can do to be of help, please let me know.

Sincerely,



Fred V. Steece
Supervisor, Western Field Office

FVS/jlm
cc: Dr. Duncan J. McGregor
Enc. 3



December 3, 1975

Mr. David Volk
State Treasurer
Capitol Office Building
Pierre, S. D. 57501

Dear Mr. Volk:

Enclosed is a check in the amount of \$100 from Power Resources Corporation to cover the drilling fee for permit #741 for an oil test in Fall River County. This check is for deposit in the general fund and a Cash Receipts Transmittal form is enclosed for the same amount.

Sincerely,

Fred V. Steece
Supervisor, Western Field Office

FVS/jlm
Enc. 2
cc: Dr. Duncan J. McGregor

SURETY



State Pub. Co., Pierre

S. Dak. Oil & Gas Board
FORM 3

BOND NO. 809878

BOND

KNOW ALL MEN BY THESE PRESENTS,

That Energy Reserves Group, Inc.

of the County of: Sedgwick In the State of: Kansas

as Principal, Seaboard Surety Company

and New York, N. Y.

as surety, authorized to do business in the State of South Dakota as surety, are held and firmly bound unto the State of South Dakota in the sum of ~~(\$5,000.00)~~ \$20,000.00, lawful money of the United States, for which payment, well and truly to be made, we bind ourselves, and each of us, and each of our heirs, executors, administrators or successors, and assigns jointly and severally, firmly by these presents.

The condition of this obligation is that whereas the above bounden principal proposes to drill a well or wells for oil, gas, or stratigraphic purposes in and upon the following described land situated within the State, to wit:

Any land situated within State of South Dakota

(May be used as blanket bond or for single well)

----- Blanket Bond -----

NOW, THEREFORE, if the above bounden principal shall comply with all of the provisions of the laws of this State and the rules, regulations and orders of the Oil and Gas Board of the State, especially with reference to the proper plugging of said well or wells, and filing with the Oil and Gas Board of this State all notices and records required by said Board, and the restoration of the surface, in the event said well or wells do not produce oil or gas in commercial quantities, or cease to produce oil or gas in commercial quantities, then this obligation shall be terminated by the Board, the same shall be and remain in full force and effect.

Penal sum of

Twenty Thousand and 00/100 Dollars (\$20,000.00)

Witness our hands and seals, this 21st day of April, 1976

Energy Reserves Group, Inc.

By [Signature]
Vice President R. D. Orr Principal

Witness our hands and seals, this 21st day of April, 1976

Seaboard Surety Company

By [Signature]
(James W. Bily)
Attorney-in-fact Surety

If the principal is a corporation, the bond should be executed by its duly authorized officers, with the seal of the corporation affixed. When principal or surety executes this bond by agent, power of attorney or other evidence of authority must accompany the bond.

DO NOT WRITE BELOW THIS LINE

Approved May 11, 1976
Date

OIL AND GAS BOARD OF THE STATE OF SOUTH DAKOTA
[Signature]
Supervisor

Countersigned in South Dakota MCKEAN / STANTON

By [Signature]
Agent at [Signature]
PAUL MCKEAN



Note: File 3 copies of this form with Secretary, Oil & Gas Board, Pierre.

New York, New York

POWER OF ATTORNEY

KNOW ALL MEN BY THESE PRESENTS: That SEABOARD SURETY COMPANY, a corporation of the state of New York, has made, constituted and appointed and by these presents does make, constitute and appoint A. C. Ardross or A. C. Riebert or James A. Egan or Robert C.

President or Evelyn Houchin or James W. Daly or Bill Hall or Donald E. Graun or Edward A. Colagrosso of the State of Kansas its true and lawful Attorney-in-Fact, to make, execute and deliver on its behalf insurance policies, surety bonds, undertakings and other instruments of similar nature as follows: Without limitation

Such insurance policies, surety bonds, undertakings and instruments for said purposes, when duly executed by the aforesaid Attorney-in-Fact, shall be binding upon the said Company as fully and to the same extent as if signed by the duly authorized officers of the Company and sealed with its corporate seal; and all the acts of said Attorney-in-Fact, pursuant to the authority hereby given, are hereby ratified and confirmed.

This appointment is made pursuant to the following By-Laws which were duly adopted by the Board of Directors of the said Company on December 8th, 1927, and are still in full force and effect:

ARTICLE VIII, SECTION 1:
"To bind the Company in contracts, stipulations, covenants of surety, underwriting undertakings and instruments relating thereto, the President, Vice-President, Secretary or Assistant Secretary, or any one or more of them, or any other officer or representative of the Company, shall be authorized to execute and deliver on behalf of the Company... (a) by the Chairman of the Board, the President, a Vice-President or a Resident Vice-President and, by the Secretary, an Assistant Secretary, a Resident Secretary or a Resident Assistant Secretary; or (b) by an Attorney-in-Fact for the Company appointed and authorized by the Chairman of the Board, the President or a Vice-President to make such signature; or (c) by such other officers or representatives of the Board as may from time to time determine.

The seal of the Company shall if appropriate be affixed thereto by any such officer, Attorney-in-Fact or representative."

IN WITNESS WHEREOF, SEABOARD SURETY COMPANY has caused these presents to be signed by one of its Vice-Presidents, and its corporate seal to be hereunto affixed and duly attested by one of its Assistant Secretaries, this 13th day of August, 1975.

Attest: SEABOARD SURETY COMPANY,
By John C. Whiteside, Vice-President
(Seal) Jean Lzech, Assistant Secretary

STATE OF NEW YORK }
COUNTY OF NEW YORK } ss.:

On this 13th day of August, 1975, before me personally appeared John C. Whiteside, a Vice-President of SEABOARD SURETY COMPANY, with whom I am personally acquainted, who, being by me duly sworn, depose and say that he resides in the State of New York; that he is a Vice-President of SEABOARD SURETY COMPANY, the corporation described in and which executed the foregoing instrument, that he knows the corporate seal of the said Company; that the seal affixed to said instrument is such corporate seal; that it was affixed to said instrument by order of the Board of Directors of said Company; and that he signed his name thereon as Vice-President of said Company by like authority.



State of New York
No. 43-4598755 Qualified in Richmond County
Court Clerk filed in New York County
(Seal) Karen Gavrity, Notary Public
Commission Expires March 30, 1977

CERTIFICATE

I, the undersigned Assistant Secretary of SEABOARD SURETY COMPANY do hereby certify that the original Power of Attorney of which the foregoing is a full, true and correct copy, is in full force and effect on the date of this certificate and I do further certify that the Vice-President who executed the said Power of Attorney was one of the officers authorized by the Board of Directors to appoint an attorney-in-fact as provided in Article VIII, Section 1, of the By-Laws of SEABOARD SURETY COMPANY.

This certificate may be signed and read by facsimile under and by authority of the following resolution of the Board of Directors of SEABOARD SURETY COMPANY at a meeting duly called and held on the 25th day of March, 1975:

"RESOLVED, (1) that the use of a printed facsimile of the corporate seal of the company and of the signature of an Assistant Secretary on any certification of the correctness of a copy of an instrument executed by the President or a Vice-President pursuant to Article VIII, Section 1, of the By-Laws appointing and authorizing an attorney-in-fact to sign the same and on behalf of the company surety bonds, underwriting undertakings or other instruments described in said Article VIII, Section 1, with like effect as if such seal and such signature had been manually affixed and made, hereby is authorized and approved."

IN WITNESS WHEREOF, I have hereunto set my hand and affixed the corporate seal of the Company to these presents this 21st day of April, 1976.



Handwritten signature of Jean Lzech



State Pub. Co., Pierre

S. Dak. Oil & Gas Board
FORM 3

BOND NO. 4001

BOND

KNOW ALL MEN BY THESE PRESENTS,

That
we POWER RESOURCES CORP.
of the DENVER In the COLORADO
County of DENVER State of
as Principal,
by HARTFORD ACCIDENT AND INDEMNITY COMPANY
of HARTFORD, CONN.

is surety, authorized to do business in the State of South Dakota, as surety, are held and firmly bound unto the State of South Dakota in the sum of \$5,000.00 (~~200,000.00~~) lawful money of the United States, for which payment, well and truly to be made, we bind ourselves, and each of us, and each of our heirs, executors, administrators or successors, and assigns jointly and severally, firmly by these presents.

The condition of this obligation is that whereas the above bounden principal proposes to drill a well or wells for oil, gas, or stratigraphic purposes in and upon the following described land situated within the State to wit:

1/4 Sec. 14, T. 1 East, R. 1 East, Fall River County, South Dakota
(to be used as a blanket bond for single well)

Sec. 14, T. 1 E. 1 N. 1 W.
Well Name #21-14 M. Lenore Petersen

NOW, THEREFORE, if the above bounden principal shall comply with all of the provisions of the laws of this State and the rules, regulations and orders of the Oil and Gas Board of the State, especially with reference to the proper plugging of said well or wells, and filing with the Oil and Gas Board of this State all notices and records required by said Board, and the restoration of the surface, in the event said well or wells do not produce oil or gas in commercial quantities, or cease to produce oil or gas in commercial quantities, then this obligation shall be terminated by the Board, the same shall be and remain in full force and effect.

For value of

Five Thousand and no/100 (\$5,000.00)

Witness our hands and seals, this 1st day of December, 1975
Attest:

[Signature]
John E. Trotter, Secretary

December 1975
POWER RESOURCES CORP.
[Signature]
Richard A. Basham, V. P. Principal

Witness our hands and seals, this 1st day of

December 1975
Hartford Accident and Indemnity Co.
[Signature]
Walt Forbes, attorney-in-fact, Surgt.
136 South Wolcott, Casper, Wyo. 82601

If the principal is a corporation, the bond should be executed by its duly authorized officers, with the seal of the corporation affixed. When principal or surety executes this bond by agent, power of attorney or other evidence of authority must accompany the bond.

DO NOT WRITE BELOW THIS LINE
OIL AND GAS BOARD OF THE STATE OF SOUTH DAKOTA
[Signature]
Superintendent

Counterfiled in South Dakota
Rec. 98
Witness [Signature]

Note: See 2 (b) of this form with Secretary, Oil & Gas Board, Pierre



HARTFORD, CONNECTICUT

POWER OF ATTORNEY

Know all men by these Presents, that the HARTFORD ACCIDENT AND INDEMNITY COMPANY, a corporation duly organized under the Laws of the State of Connecticut, and having its principal office in the City of Hartford, County of Hartford, State of Connecticut, does hereby make, execute, ratify and confirm:

WALT FORBES, W. W. BUTLER, SHIRLEY L. McPHERSON, and THOMAS L. MYERS, of CASPER, WYOMING,

its true and lawful Attorney(s) in fact, with full power and authority to each of said Attorney(s) and each of them separate and apart, if more than one is named above, to sign, execute, and acknowledge any and all bonds and undertakings and other writings obligatory in the nature thereof on behalf of the Company or its business, and to execute the holding of any and all such places of public or private trust, and entering the performance of contracts (other than insurance policies, 2) and to accept the performance of insurance contracts whose surety bonds are accepted by states and municipalities, and to execute all guarantying bonds and undertakings required or permitted in all actions or proceedings or by Law allowed

in penalties not exceeding the sum of FIVE HUNDRED THOUSAND DOLLARS (\$500,000.00) each,

and to bind the HARTFORD ACCIDENT AND INDEMNITY COMPANY thereby as fully and to the same extent as if such bonds and undertakings and other writings obligatory in the nature thereof were signed by an Executive Officer of the HARTFORD ACCIDENT AND INDEMNITY COMPANY and sealed and attested by one other of such officers, and hereby ratifies and confirms all that its said Attorney(s) in fact may do in pursuance hereof.

This power of attorney is granted under and by authority of the following By-Law adopted by the Stockholders of the HARTFORD ACCIDENT AND INDEMNITY COMPANY at a meeting duly called and held on the 10th day of February, 1944:

ARTICLE IV

SECTION 8. The President or any Vice-President, acting with any Secretary or Assistant Secretary, shall have power and authority to execute for purposes only of executing and attesting bonds and undertakings and other writings obligatory in the nature thereof, one or more Resident Vice-Presidents, Resident Assistant Secretaries and Attorneys-in-fact and at any time to remove any such Resident Vice-President, Resident Assistant Secretary, or Attorney-in-fact, and revoke the power and authority given to him. SECTION 11. Attorneys-in-fact shall have power and authority, subject to the terms and limitations of the power of attorney issued to them, to execute and deliver on behalf of the Company and to attach the seal of the Company thereto any and all bonds and undertakings, and other writings obligatory in the nature thereof, and any such instrument executed by any such Attorney in fact shall be as binding upon the Corporation as if signed by an Executive Officer and sealed and attested by one other of such Officers.

This power of attorney is signed and sealed by facsimile under and by the authority of the following Resolution adopted by the Directors of the HARTFORD ACCIDENT AND INDEMNITY COMPANY at a meeting duly called and held on the 13th day of March, 1956:

RESOLVED that, who was the President or any Vice-President, acting with any Secretary or Assistant Secretary, has the power and authority to execute by a power of attorney, for purposes only of executing and attesting bonds and undertakings and other writings obligatory in the nature thereof, one or more Resident Vice-Presidents, Assistant Secretaries and Attorneys in fact.

Now therefore the signatures of such officers and the seal of the Company may be affixed to any such power of attorney or to any certificate thereunder by facsimile, and any such power of attorney or certificate bearing such facsimile signatures or facsimile seal shall be valid and binding upon the Corporation as if signed and sealed by the said officers and the seal of the Company in person, and the same shall be valid and binding upon the Corporation as if signed and sealed by the said officers and the seal of the Company in person.

In Witness Whereof, the HARTFORD ACCIDENT AND INDEMNITY COMPANY has caused these presents to be signed by its Vice-President, and its corporate seal to be hereto affixed, duly attested by its Secretary, this 17th day of January, 1968.

WALTER H. BROWN Secretary JOHN F. BEARDSLEY Vice President

STATE OF CONNECTICUT,) ss. COUNTY OF HARTFORD,) On this 17th day of January, A. D. 1968, before me personally came John F. Beardsley, to me known, who being by me duly sworn, did depose and say, that he resides in the County of Hartford, State of Connecticut, that he is the Vice-President of the HARTFORD ACCIDENT AND INDEMNITY COMPANY, the corporation described in and which executed the above instrument, that he knows the seal of the said corporation, that the seal affixed to the said instrument is such corporate seal, that it was so affixed by order of the Board of Directors of said corporation and that he signed his name thereto by like order.

STATE OF CONNECTICUT,) ss. COUNTY OF HARTFORD,) ROBERT G. PHELPS My Commission expires March 31, 1967

CERTIFICATE

I, the undersigned, Assistant Secretary of the HARTFORD ACCIDENT AND INDEMNITY COMPANY, a Connecticut Corporation, DO HEREBY CERTIFY that the foregoing and attached POWER OF ATTORNEY remains in full force and has not been revoked; and furthermore, that Article IV, Sections 8 and 11, of the By-Laws of the Company, and the Resolution of the Board of Directors, set forth in the Power of Attorney, is now in force.

Signed and sealed in the City of Hartford. Dated the 14th day of December, 1975.

WALTER H. BROWN Assistant Secretary

MISCELLANEOUS



**NO MISCELLANEOUS
INFORMATION FOR THIS WELL
AS OF 5/18/2011**

ORIGINAL WELL CONSTRUCTION DURING OPERATION

PLUGGING AND ABANDONMENT CONSTRUCTION

API No. 4004720065
14-7S-1E

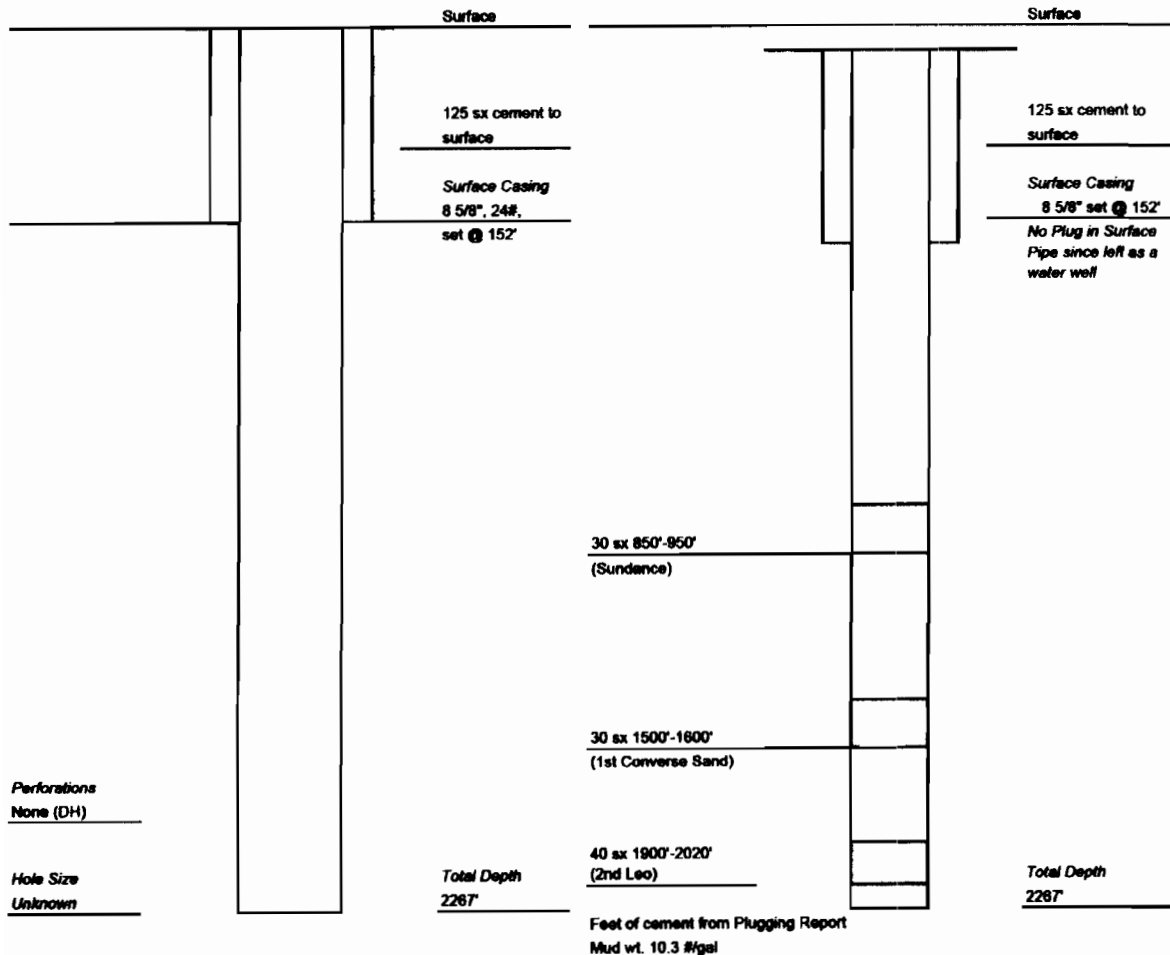



Oil and Gas Search for: <i>api_no_like '40 033 05219'</i>		
Page 1 of 1	<u>Download Database</u> (Excel spreadsheet format)	Page: 1

Record 1 of 1

Well Information

API No:	40 033 05219	County:	CUSTER
Well Name:	CARTER 1	Location:	SWSE 19-6S-1E
Permit No:	H31-3	Total Depth:	405
Operator Name:	CARTER OIL COMPANY	Bottom Hole:	Fall River
Permit Date:	01-01-1931	KB Elevation:	
Spud Date:	01-01-1931	Ground Elevation:	3690
Plug Date:	01-01-1931	Latitude:	43.508820
		Longitude:	-104.042397
Well Field	WILDCAT	Status	P&A
Class:	DRY HOLE	Type:	DRY HOLE

Formation Tops

<u>Formation</u>	<u>Depth (ft.)</u>
Fall River	395

Page 1 of 1 (goto top)	Page: 1
-------------------------------	----------------

Submittal Requirements for Building Permit Application Communication Tower:

Evidence of Ownership: * A copy of a recorded deed from the Clerk & Recorder's Office.

Proof/Issuance of Address: * Required prior to beginning construction. To apply for an address, the cost of the permit is \$75.00 & permits can be obtained at the Building Department. Questions may be directed to the Planning & Zoning Department @ 276-7360.

County Driveway Access Permit & Inspection Report Approved by District Supervisor: * Required prior to beginning construction. The cost of the permit is \$55.00 & permits can be obtained at the Building Department. If there's an existing driveway, it's required that a driveway inspection be performed by a Road & Bridge designee. Questions may be directed to the Road & Bridge Department @ 276-7320.

State Highway Access Permit: * Required prior to beginning construction. If access is taken from a state highway, questions may be directed to the Colorado Department of Transportation, Region 2 Access Management Unit @ (719)-546-5407.

Plot Plan: ** May be prepared by applicant & must be legible. Plot plan must contain the following: Any questions regarding the property set-backs, please call Planning & Zoning @ 719-276-7360.

- Configuration of lot & all property dimensions.
- Location on lot & the dimensions of all structures. Identify each structure as "existing" or "proposed."
- Setback distances from proposed structures to all property lines & to any existing buildings.
- Location & name of any public or private roads which adjoin or trespass property.
- Location that driveway enters property from public or private road. Driveway will determine "front" of property.
- North arrow clearly visible.

Foundation Design: ** Any & all foundation designs must be prepared, signed, & sealed by an engineer or architect licensed by the State of Colorado.

Construction Details: ** Details must identify structural components & must verify compliance with the 2006 International Residential Code &/or 2006 International Building Code & 2006 International Energy Conservation Code. May be prepared by applicant & may be drawn or in written form. Details must identify structural components such as floor support beam sizes, floor joist size & spacing, wall stud size & spacing, header sizes for all openings, roof assembly components or engineering from truss manufacturer, etc. Roof snow load depends on the construction elevation. Where special conditions exist, the building official is authorized to require additional construction documents to be prepared, signed & sealed by an engineer licensed in the State of Colorado. For identification purposes, every page must contain the client's name & construction address.

Fire Department Permit: * Required only if in the Cañon City, Colorado Area Fire Protection District.

Drainage Study: ** Must be prepared, signed, & sealed by a Colorado licensed professional engineer.

- <http://www.dora.state.co.us/electrical/onlinepermitsystem.htm>
- State Electrical Inspector: Robert Brant - (719)-275-2816
- <http://www.dora.state.co.us/plumbing/forms.htm#info>
- State Plumbing Inspector: Gary Hartsuiker - (719)-269-1255
- Colorado Division of Water Resources: <http://water.state.co.us/default.htm>

***(1) / **(2) - Indicates number of copies to be submitted.
INCOMPLETE OR FAXED SUBMITTALS WILL NOT BE ACCEPTED.**

Submittal Requirements for Building Permit Application Communication Tower:

Evidence of Ownership: * A copy of a recorded deed from the Clerk & Recorder's Office.

Proof/Issuance of Address: * Required prior to beginning construction. To apply for an address, the cost of the permit is \$75.00 & permits can be obtained at the Building Department. Questions may be directed to the Planning & Zoning Department @ 276-7360.

County Driveway Access Permit & Inspection Report Approved by District Supervisor: * Required prior to beginning construction. The cost of the permit is \$55.00 & permits can be obtained at the Building Department. If there's an existing driveway, it's required that a driveway inspection be performed by a Road & Bridge designee. Questions may be directed to the Road & Bridge Department @ 276-7320.

State Highway Access Permit: * Required prior to beginning construction. If access is taken from a state highway, questions may be directed to the Colorado Department of Transportation, Region 2 Access Management Unit @ (719)-546-5407.

Plot Plan: * * May be prepared by applicant & must be legible. Plot plan must contain the following: Any questions regarding the property set-backs, please call Planning & Zoning @ 719-276-7360.

- Configuration of lot & all property dimensions.
- Location on lot & the dimensions of all structures. Identify each structure as "existing" or "proposed."
- Setback distances from proposed structures to all property lines & to any existing buildings.
- Location & name of any public or private roads which adjoin or trespass property.
- Location that driveway enters property from public or private road. Driveway will determine "front" of property.
- North arrow clearly visible.

Foundation Design: * * Any & all foundation designs must be prepared, signed, & sealed by an engineer or architect licensed by the State of Colorado.

Construction Details: * * Details must identify structural components & must verify compliance with the 2006 International Residential Code &/or 2006 International Building Code & 2006 International Energy Conservation Code. May be prepared by applicant & may be drawn or in written form. Details must identify structural components such as floor support beam sizes, floor joist size & spacing, wall stud size & spacing, header sizes for all openings, roof assembly components or engineering from truss manufacturer, etc. Roof snow load depends on the construction elevation. Where special conditions exist, the building official is authorized to require additional construction documents to be prepared, signed & sealed by an engineer licensed in the State of Colorado. For identification purposes, every page must contain the client's name & construction address.

Fire Department Permit: * Required only if in the Cañon City, Colorado Area Fire Protection District.

Drainage Study: * * Must be prepared, signed, & sealed by a Colorado licensed professional engineer.

- <http://www.dora.state.co.us/electrical/onlinepermitsystem.htm>
- State Electrical Inspector: Robert Brant - (719)-275-2816
- <http://www.dora.state.co.us/plumbing/forms.htm#info>
- State Plumbing Inspector: Gary Hartsuiker - (719)-269-1255
- Colorado Division of Water Resources: <http://water.state.co.us/default.htm>

***(1) / **(2) - Indicates number of copies to be submitted.
INCOMPLETE OR FAXED SUBMITTALS WILL NOT BE ACCEPTED.**

Sample Analysis Report

CLIENT: Exterran
P. O. Box 6795
Sheridan, WY 82801

Date Reported: 2/1/2012
Report ID: S1201249001

Project: Lance Oil & Gas-Kinney Draw
Lab ID: S1201249-002
Client Sample ID: Treated Water Pond
Station ID: DP_WY0056081_019_TWP

Work Order: S1201249
Collection Date: 1/18/2012 11:15 AM
Date Received: 1/18/2012 4:30 PM
Matrix: Water
COC: 4479

Analyses	Result	RL	Qual	Units	Date Analyzed/Init	Method
Field						
pH	7.73			s.u.	01/18/2012 1115	Field
pH (SCADA)	7.70				01/18/2012 1115	Field
Conductivity	1845			µmhos/cm	01/18/2012 1115	Field
Conductivity (SCADA)	1987			µmhos/cm	01/18/2012 1115	Field
Chloride	32.0			mg/L	01/18/2012 1115	Field
Temperature	55.8			°F	01/18/2012 1115	Field
General Parameters						
pH	8.4	0.1		s.u.	01/20/2012 1949 MZ	SM 4500 H B
Electrical Conductivity	1970	5		µmhos/cm	01/20/2012 1949 MZ	SM 2510B
Total Dissolved Solids (180)	1200	10		mg/L	01/30/2012 1316 ARF	SM 2540
Solids, Total Dissolved (Calc)	1200	10		mg/L	01/27/2012 925 ALA	SM 1030E
Alkalinity, Total (As CaCO3)	1030	5		mg/L	01/20/2012 1949 MZ	SM 2320B
Hardness, Calcium/Magnesium (As CaCO3)	20	1		mg/L	01/27/2012 925 ALA	SM 2340B
Sodium Adsorption Ratio	50.9	0.1			01/27/2012 925 ALA	Calculation
Anions						
Alkalinity, Bicarbonate as HCO3	1220	5		mg/L	01/20/2012 1949 MZ	SM 2320B
Alkalinity, Carbonate as CO3	20	5		mg/L	01/20/2012 1949 MZ	SM 2320B
Alkalinity, Hydroxide as OH	ND	5		mg/L	01/20/2012 1949 MZ	SM 2320B
Chloride	36	1		mg/L	01/19/2012 1220 AMB	EPA 300.0
Fluoride	1.4	0.1		mg/L	01/20/2012 1949 MZ	SM 4500FC
Sulfate	ND	1		mg/L	01/19/2012 1220 AMB	EPA 300.0
Cations						
Calcium	4.8	0.5		mg/L	01/19/2012 1538 DG	EPA 200.7
Magnesium	1.9	0.5		mg/L	01/19/2012 1538 DG	EPA 200.7
Potassium	18.7	0.5		mg/L	01/19/2012 1538 DG	EPA 200.7
Sodium	518	0.1		mg/L	01/19/2012 1538 DG	EPA 200.7
Cation/Anion-Milliequivalents						
Calcium	0.23	0.01		meq/L	01/27/2012 925 ALA	SM 1030E
Magnesium	0.15	0.01		meq/L	01/27/2012 925 ALA	SM 1030E
Potassium	0.47	0.01		meq/L	01/27/2012 925 ALA	SM 1030E
Sodium	22.53	0.01		meq/L	01/27/2012 925 ALA	SM 1030E
Hardness	ND	0.01		meq/L	01/27/2012 925 ALA	Calculation

These results apply only to the samples tested.

RL - Reporting Limit

- | | | |
|--------------------|---|---|
| Qualifiers: | <ul style="list-style-type: none"> * Value exceeds Maximum Contaminant Level C Calculated Value H Holding times for preparation or analysis exceeded L Analyzed by a contract laboratory ND Not Detected at the Reporting Limit S Spike Recovery outside accepted recovery limits | <ul style="list-style-type: none"> B Analyte detected in the associated Method Blank E Value above quantitation range J Analyte detected below quantitation limits M Value exceeds Monthly Ave or MCL O Outside the Range of Dilutions |
|--------------------|---|---|

Reviewed by: A. Aletti
Adrien Aletti, Project Manager

Sample Analysis Report

CLIENT: Exterran
P. O. Box 6795
Sheridan, WY 82801

Date Reported: 2/1/2012
Report ID: S1201249001

Project: Lance Oil & Gas-Kinney Draw
Lab ID: S1201249-002
Client Sample ID: Treated Water Pond
Station ID: DP_WY0056081_019_TWP

Work Order: S1201249
Collection Date: 1/18/2012 11:15 AM
Date Received: 1/18/2012 4:30 PM
Matrix: Water
COC: 4479

Analyses	Result	RL	Qual	Units	Date Analyzed/Init	Method
Cation / Anion Balance						
Cation Sum	23.41	0.01		meq/L	01/27/2012 925 ALA	SM 1030E
Anion Sum	21.78	0.01		meq/L	01/27/2012 925 ALA	SM 1030E
Cation-Anion Balance	3.58	0.01		%	01/27/2012 925 ALA	SM 1030E
Dissolved Metals						
Barium	0.248	0.005		mg/L	01/19/2012 1254 MS	EPA 200.8
Total Metals						
Barium	0.255	0.005		mg/L	01/19/2012 1259 MS	EPA 200.8

These results apply only to the samples tested.

RL - Reporting Limit

- | | | |
|--------------------|--|---|
| Qualifiers: | * Value exceeds Maximum Contaminant Level | B Analyte detected in the associated Method Blank |
| | C Calculated Value | E Value above quantitation range |
| | H Holding times for preparation or analysis exceeded | J Analyte detected below quantitation limits |
| | L Analyzed by a contract laboratory | M Value exceeds Monthly Ave or MCL |
| | ND Not Detected at the Reporting Limit | O Outside the Range of Dilutions |
| | S Spike Recovery outside accepted recovery limits | |

Reviewed by: 
Adrien Aletti, Project Manager



Oil and Gas Search for: <i>api_no_ like '40 033 05221'</i>		
Page 1 of 1	<u>Download Database</u> (Excel spreadsheet format)	Page: 1

Record 1 of 1

Well Information

API No:	40 033 05221	County:	CUSTER
Well Name:	CARTER 2	Location:	SWSE 19-6S-1E
Permit No:	H32-2	Total Depth:	420
Operator Name:	CARTER OIL COMPANY	Bottom Hole:	Fall River
Permit Date:	01-01-1932	KB Elevation:	
Spud Date:	01-01-1932	Ground Elevation:	3690
Plug Date:	01-01-1932	Latitude:	43.508820
		Longitude:	-104.042397
Well Field	WILDCAT	Status	P&A
Class:	DRY HOLE	Type:	DRY HOLE

Formation Tops

<u>Formation</u>	<u>Depth (ft.)</u>
Red River	300

Page 1 of 1 (goto top)	Page: 1
-------------------------------	----------------

COUNTY: CUSTER
LEGAL LOCATION: SWSE 19-6S-1E
API NO: 40 033 05221
PERMIT NO: H32-2
WELL NAME: CARTER #2
OPERATOR: CARTER OIL COMPANY
PERMIT ISSUED:
PERMIT CLOSED:
FILE LOCATION: 6S-1E-19 SWSE

TARGET CODES:

WELL HISTORY / CHECKLIST

PERMIT TO DRILL / INTENT TO DRILL

WELL INSPECTION / SCOUT REPORTS

OPERATOR'S TECHNICAL REPORTS / MAPS

ADMINISTRATIVE / SUNDRY REPORTS

CORRESPONDENCE

SURETY

MISCELLANEOUS

WELL HISTORY / CHECKLIST

**NO WELL HISTORY OR
CHECKLIST FOR THIS WELL
AS OF 9/21/2011**



PERMIT TO DRILL / INTENT TO DRILL

**NO PERMIT TO DRILL OR INTENT
TO DRILL FOR THIS WELL
AS OF 9/21/2011**

WELL INSPECTION / SCOUT REPORTS

**NO WELL INSPECTION OR SCOUT
REPORTS FOR THIS WELL
AS OF 9/21/2011**

OPERATOR'S TECHNICAL REPORTS / MAPS



**NO OPERATOR'S TECHNICAL
REPORTS OR MAPS FOR THIS WELL
AS OF 9/21/2011**

ADMINISTRATIVE / SUNDRY REPORTS

**NO ADMINISTRATIVE OR SUNDRY
REPORTS FOR THIS WELL
AS OF 9/21/2011**



CORRESPONDENCE

**NO CORRESPONDENCE FOR
THIS WELL AS OF 9/21/2011**

SURETY

**NO SURETY INFORMATION FOR
THIS WELL AS OF 9/21/2011**

MISCELLANEOUS

12.

Carter #2
Drig Date 1931
T. D. 405 Water Well
Surface - Graneros
395-405 Dak. Water

NE SW SE 19-6S-1E

From USGS files, Newcastle



9

No.	Date	Name	Location	Eleva- tion	Total Depth	Green- horn	Da- kota	Fall River
<u>Custer County--continued</u>								
7	1931	Carter #1	SW SE 19-6S-1E	3690±	405			395?
8	1932?	Carter #2	SW SE 19-6S-1E	3690±	420			300?
9	1956	Continental #1 Harrison	SW SE 24-3S-8E	3208K	1544	662	1100	1507
10	1956	Continental #1 Larson	SW SE 33-2S-8E	3252K	953		548	940
11	1963	Dodgin #1 Coffing	SE NE NW 34-6S-2E	4211	1367			
12	1963	Dodgin #1 Cornelison	SW NW 26-5S-1E	4116K	763			
13	1946	Dover #1 Government- Christians	NE SW 30-5S-2E	4332	851			
14	1950	Fairbourn #1	SE 19-4S-8E	3280±	7401			630±
15	1957	Gary #1 Bohling	NE SE 21-3S-10E	2864K	2500	1559	2002	2430
16	1957	Gary #1 O'Neill	SW NW 23-3S-11E	2804K	2563	1551	2040	2510
17	1957	Gary #1 Wilsey	NW SW 30-3S-10E	3017K	2510	1619	2025	2471
18	1957	Gary #1 Young	NE NW 21-4S-8E	3465K	1605	660	1113	1538
19	1934	Gokel #1 Govern- ment-Halterman	SW NW 1-6S-1E	4040±	1047			
20	1956	Great Western Eyres #1 Coffing	SW SW 27-6S-2E	4141	1378			
21	1958	Harris #1 Rothleutner	NE SW 7-6S-2E	4040±	1200			

10

Minne- kahta	Minne- lusa	Madi- son	Devo- nian	Red River	Pre- Cam- brian	Logs	Remarks	No.
<u>Custer County--continued</u>								
						s		7
						s		8
						E,ML	Cored 1100-1225,1240-93	9
								10
680						GRN	Production from 1379-1385	11
284	350					GRN	Oil show 745-54	12
	140					s		13
						s	Water at 740 _± with oil	14
						E,ML,S		15
						E,ML,S		16
						E,ML,S		17
						E,ML,S		18
	141					D,s	Oil show 682-704, Gas show 805-7,908-12	19
568	640					GRN	Oil show 1365, DST 1357- 68	20
407	500					E,S		21

circ. 35



Oil and Gas Search for: <i>api_no_ like '40 047 05089'</i>		
Page 1 of 1	<u>Download Database</u> (Excel spreadsheet format)	Page: Prev 1 Next

Record 1 of 1

Well Information

API No:	40 047 05089	County:	FALL RIVER
Well Name:	SUN 1 LANCE NELSON	Location:	NESE 21-7S-1E
Permit No:	356	Total Depth:	3057
Operator Name:	SUN OIL COMPANY	Bottom Hole:	Madison
Permit Date:	01-27-1964	KB Elevation:	3535
Spud Date:	02-04-1964	Ground Elevation:	3526
Plug Date:	02-22-1964	Latitude:	43.425795
		Longitude:	-103.997224
Well Field	WILDCAT	Status	P&A
Class:	DRY HOLE	Type:	DRY HOLE

Formation Tops

<u>Formation</u>	<u>Depth (ft.)</u>
Fall River	366
Lakota	562
Morrison	653
Sundance	850
Spearfish	1152
Minnekahta	1726
Opeche	1764
Minnelusa	1838
Red Marker	2272
2nd Leo	2384
3rd Leo	2618
Madison	2989

Page 1 of 1 (goto top)	Page: Prev 1 Next
--	--------------------------

COUNTY: FALL RIVER
LEGAL LOCATION: NESE 21-7N-1E
API NO: 40 047 05089
PERMIT NO: 356
WELL NAME: SUN #1 LANCE-NELSON
OPERATOR: SUN OIL COMPANY
PERMIT ISSUED: 01/27/1964
PERMIT CLOSED: 09/02/1964
FILE LOCATION: 7N-1E-21 NESE

TARGET CODES:

WELL HISTORY / CHECKLIST

PERMIT TO DRILL / INTENT TO DRILL

WELL INSPECTION / SCOUT REPORTS

OPERATOR'S TECHNICAL REPORTS / MAPS

ADMINISTRATIVE / SUNDRY REPORTS

CORRESPONDENCE

SURETY

MISCELLANEOUS

WELL HISTORY / CHECKLIST

WELL HISTORY

Well Name Sun #1 Lance-Nelson Permit No. 356

Location NESE 21-7S-1E - Fall River Date of Permit 1-27-64

Elev. 3526.0' API No. _____

Confidential X From _____ To 8-21-64

Logs Received _____

Cuttings Received _____ Cores Received _____

Drill Stem Records _____

Cap Plug and Marker Set 2-28-64

Surface Restored 5-12-64

Plugging Affidavit Signed _____ Date _____

Bond Released _____ Date 9-2-64

Summary of Scout Reports

2-1-64 No equipment at location - First report

2-7-64 Spudded 2-4-64

2-22-64 Plugged

2-28-64 Rig moved out - Marker placed - Mud pits not filled

5-12-64 Mud pits filled & surface restored

PERMIT TO DRILL / INTENT TO DRILL

State Pub. Co., Pierre **APPLICATION FOR PERMIT TO:** S. Dak. Oil & Gas Board
FORM 2

<input checked="" type="checkbox"/> DRILL <input type="checkbox"/> DEEPEN <input type="checkbox"/> PLUG BACK <input type="checkbox"/> OIL WELL <input type="checkbox"/> GAS WELL <input type="checkbox"/> MULTIPLE ZONE	FARM OR LEASE NAME Lance - Nelson Estate WELL NO. 1 FIELD AND POOL, OR WILDCAT Wildcat NO. ACRES IN LEASE 40 COUNTY Fall River County	
OPERATOR Sun Oil Company		
ADDRESS P.O. Box 1798 (mailing Address) 800 Security Life Bldg. Denver, Colorado Phone: 266-2181		
LOCATION (In feet from nearest lines of section or legal subdivision, where possible)* 1980' North of South Line & 660' West of East Line of Section 21, Township 7S, Range 1E, Fall River, South Dakota		
NAME AND ADDRESS OF SURFACE OWNER First National Bank of Black Hills, Trustee of the Nelson Estate	ELEVATION 3526.0' PROPOSED DEPTH 3200	NO. OF WELLS ETC. none ROTARY OR CABLE TOOLS Rotary Tools
NAME AND ADDRESS OF CONTRACTOR Unknown		APPROXIMATE DATE WORK WILL START January 16, 1964

IF LEASE PURCHASED WITH ANY WELLS DRILLED, FROM WHOM PURCHASED (Name and address)
 - -

PROPOSED CASING AND CEMENTING PROGRAM					
SIZE OF HOLE	SIZE OF CASING	WEIGHT PER FOOT	NEW OR SECOND HAND	DEPTH	SACKS OF CEMENT
12-1/4"	8-5/8"	24#	New	200'	150
7-7/8"	4-1/2"	9.5#	New	3200'	200

DESCRIBE PROPOSED OPERATIONS. IF PROPOSAL IS TO DEEPEN OR PLUG BACK, GIVE DATA ON PRESENT PRODUCTIVE ZONE AND PROPOSED NEW PRODUCTIVE ZONE. GIVE BLOW OUT PREVENTER PROGRAM IF ANY

Principal Objective is Minnelusa Ss
 Certified Location Plat Attached
 Check in the amount of \$100.00 covering the drilling permit fee attached.

 A \$5000 bond from our South Dakota agent will be submitted in the very near future.

 Please wire your approval to drill this well to the undersigned when everything is in order.

SIGNED W.J. Turner TITLE Div. Supt. - Oper. Dept. DATE January 7, 1964
 DO NOT WRITE BELOW THIS LINE
 PERMIT NO. 356 CHECKED BY [Signature] 1/9/64
 School and Public Lands Date
 APPROVAL DATE January 27, 1964 Secretary

- CONDITIONS:
 COMPLETE SET OF SAMPLES, AND CORES IF TAKEN, MUST BE SUBMITTED.
 SAMPLES, AND CORES IF TAKEN, BELOW _____ DEPTH, MUST BE SUBMITTED.

*See Instructions On Reverse Side

SECTION 21
T.7S., R.1E, EAST OF THE BLACK HILLS MERIDIAN
FALL RIVER COUNTY, SOUTH DAKOTA

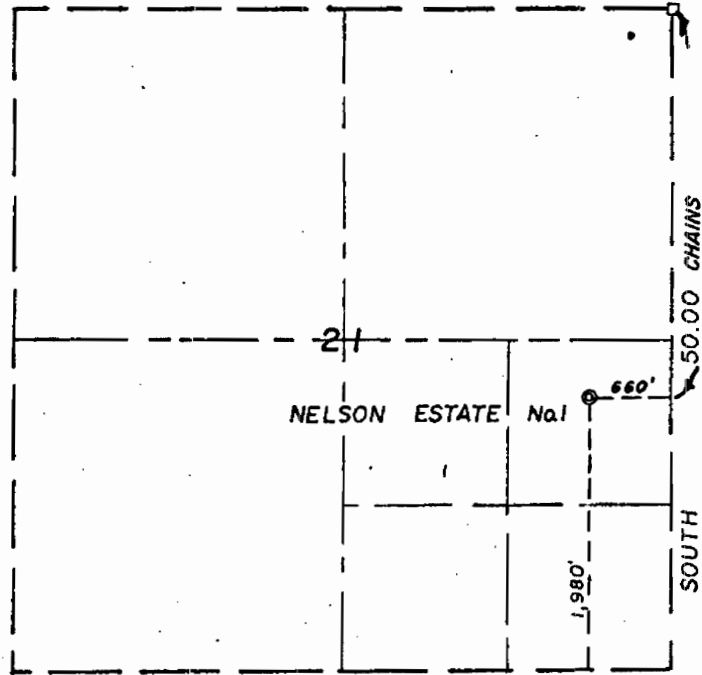
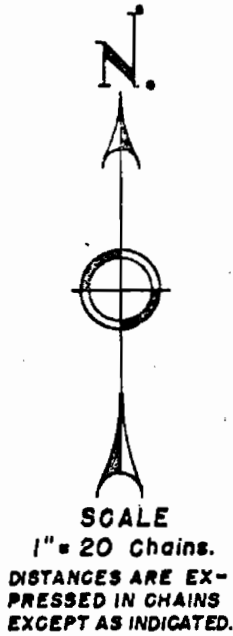

LEGEND

- U.S. Government Brass Cap Corner.....○
- Original stone corner, properly marked, firmly set.....●
- Iron pipe set at proportionate distance.....○
- Corner established by others as indicated.....□
- Dependent Resurvey.....—
- Practraction.....—
- Well location.....○

ELEVATIONS:

- LOCATION.....3526.0
- R.P. 100' N.....3526.6
- 100'S.....3526.5
- 100'E.....3526.4
- 100'W.....3526.3

SURVEY AND PLAT BY
WORTHINGTON, LENHART & ASSOCIATES, INC.
 200 South Lowell St., Casper, Wyoming
 Direct solar lines and chained distances. Ref. Book No. 247, P. 64

**PLATTED FIELD NOTES OF SURVEY
 MARKING WELL LOCATION
 NE 1/4 SE 1/4, SECTION 21
 FOR**

SUN OIL COMPANY..... CASPER, WYOMING



William G. Ladd
 Certified true and correct, Surveyor.
 SOUTH DAKOTA REG. NO. 1255

Dated: 1-6-64
 Work Order NO. 1-2-A4

WELL INSPECTION / SCOUT REPORTS



CONFIDENTIAL

STATE GEOLOGICAL SURVEY

Permit Number 356

Scout Report

Date scouted May 12, 1964

Owner. Sun Oil Company

Designation of well. . . #1 Lance-Nelson

Location: Sec. 21 T. 7 N. R. 1 E. W.

. Fall River County, S. D. Total Depth . . . 3,057 feet

Casing Record:

8 5/8 269 Ft. Ft.
Ft. Ft.

Work in progress at time of visit:

None

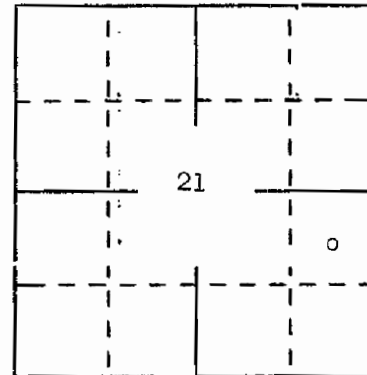

Developments since last visit:

Mud pits have been filled and the surface satisfactorily restored.

Remarks and recommendations:

Scouted by. Earl Cox, Geologist

Approved by [Signature] Duncan J. McGregor, State Geologist



STATE GEOLOGICAL SURVEY

Scout Report

Date scouted . February 28, 1964

Owner. Sun Oil Company

Designation of well. #1 Lance-Nelson

Location: Sec. 21 T. 7 N. S. R. 1 E. W.
. Fall River County, S. D. Total Depth . . . 3057 feet

Casing Record:

8 5/8" 269 Ft. Ft.
Ft. Ft.

Work in progress at time of visit:

None

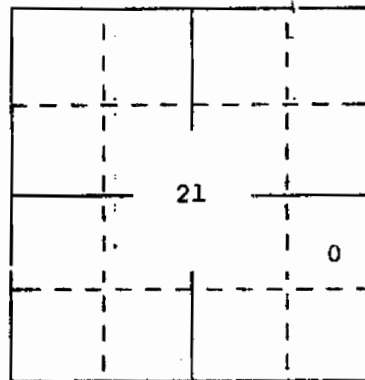

Developments since last visit:

Rig moved from location.
Abandonment marker placed.

Remarks and recommendations:

Mud pits not filled.

Earl Cox, Geologist

Scouted by

Approved by Duncan J. McGregor State Geologist

STATE GEOLOGICAL SURVEY

All information on this test may be released immediately to anyone.

Scout Report

Permit No. 356

Date scouted February 22, 1964

Owner Sun Oil Company

Designation of well #1 Lance-Nelson

Location: Sec. 21 T. 7 N. S. R. 1 E. W.

. . . Fall River County, S. D. Total Depth . . . 3057 feet (T.D.)

Casing Record:

8 5/8" 269 Ft. Ft.
 Ft. Ft.

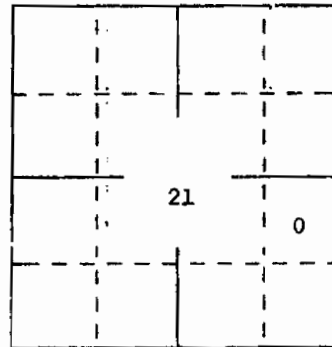

Phone: Work in progress at time of visit:

Plugged as follows:

- 25 5x 2977-3057 Madison
- 25 5x 2360-2440 2nd Leo Sand
- 25 5x 1800-1880 Minnelusa
- 25 5x 820- 900 Top Sundance
- 40 5x 330- 460 Top Dakota
- 25 5x 220- 290 Bottom Surface Casing
- 10 5x Surface Plug

Developments since last visit:

Drilled from 2916'-3057'.
 Run laterolog and gamma ray sonic logs.

Remarks and recommendations:

Log Tops:

Dakota 368	Gypsum Springs - 1151	2nd Leo - 2384
Lakota - 562	Spearfish - 1186	3rd Leo - 2618 (?)
Morrison - 653	Minnelusa - 1842	Madison - 2990
Sundance - 850	Red Marker - 2271	T.D. - 3057

Scouted by Earl Cox, Geologist

Approved by *Duncan J. McGregor*
 Duncan J. McGregor, State Geologist

STATE GEOLOGICAL SURVEY

Scout Report

Hold this information confidential until well is plugged.

Date scouted February 20, 1964

Owner Sun Oil Company

Designation of well #1 Lance-Nelson

Location: Sec. 21 T. 7 N. S. R. 1 E. W.

. . . Fall River County, S. D. Total Depth . . 2916 feet

Casing Record:

8 5/8" 269 Ft. Ft.
 Ft. Ft.

Work in progress at time of visit:

Drilling at 2916.

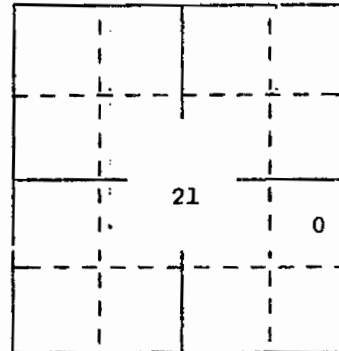

Developments since last visit:

DST #1 2315-33. Shut in 30 min., open 60 min., shut in 40 min.
 Recovered 15 feet drilling mud.
 Shut in pressures - 15-27
 Flow pressures - 15-27
 Hydro Static pressures - 1211-1143
 Temp. - 67° (oil show in samples 2318-25)

DST #2 2390-2400. (Second Leo) Shut in 30 min; open 60 min; shut in 30 min.

~~Remarks and recommendations~~

Recovered 2036' black sulphur water, slightly gas cut.
 Shut in pressures 1026-1026
 Flow pressures 144-884
 Hydrostatic pressures 1341-1241
 Temp. - 84°

Scouted by . . . Earl Cox, Geologist

Approved by *Duncan J. McGregor*
 Duncan J. McGregor, State Geologist



STATE GEOLOGICAL SURVEY

Scout Report

Date scouted . February 14, 1964

Owner. Sun Oil Company

Designation of well. . #1. Lance-Nelson

Location: Sec. 21 T. 7 N. S. R. 1 E. N.

. . . Fall River County, S. D. Total Depth . . 2333 feet

Casing Record:

8 5/8" 269 Ft. Ft.

Ft. Ft.

Work in progress at time of visit:

Preparing to drill stem test at 2333' after obtaining oil show.

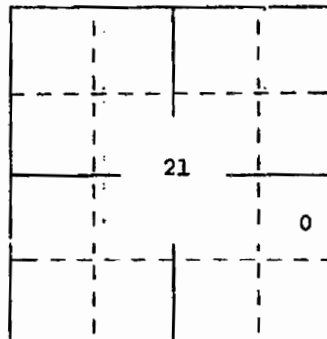

Developments since last visit:

Drilled from 300-2333'.

Elevation: Gd - 3526
KB - +8.5

Remarks and recommendations:

- Sample Tops: Dakota - 370 Morrison - 710 Sundance - 870 Spearfish - 1186 Minnekahta - 1727 Opeche - 1795 Minnelusa - 1840 Red Marker - 2272

Scouted by. Earl Cox, Geologist

Approved by [Signature]
Duncan J. McGregor, State Geologist



STATE GEOLOGICAL SURVEY

Scout Report

Date scouted February 7, 1964 .

Owner. Sun Oil Company

Designation of well. #1 Lance - Nelson

Location: Sec. 21 T. 7 N. S. R. 1 E. W.

. . Fall River County, S. D. Total Depth . . 300 feet

Casing Record:

8 5/8 269 Ft. Ft.

Ft. Ft.

Work in progress at time of visit:

Preparing to drill out from under surface casing

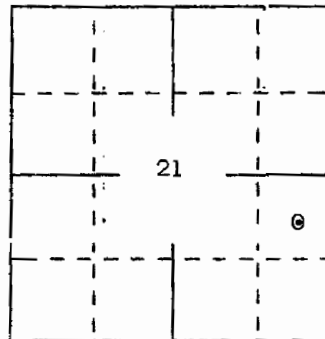

Developments since last visit:

Spudded: February 4, 1964

Set 269' of 8 5/8" surface casing with 175 sacks.

Remarks and recommendations:

Scouted by. . . Earl Cox, Geologist

Approved by *Duncan J. McGregor*
Duncan J. McGregor, State Geologist

STATE GEOLOGICAL SURVEY

Scout Report

Date scouted February 1, 1964 .

Owner. Sun Oil Company

Designation of well. #1 Lance - Nelson

Location: Sec. 21 T. 7 N. S. R. 1 E. W.

. . . Fall River County, S. D. Total Depth . . . 0 feet

Casing Record:

_____ Ft. _____ Ft.

_____ Ft. _____ Ft.

Work in progress at time of visit:

None

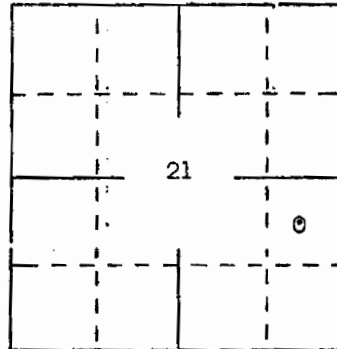

Developments since last visit:

Remarks and recommendations:

Pits not dug.

No equipment at location

Scouted by. Earl Cox, Geologist

Approved by *Duncan J. McGregor*
Duncan J. McGregor, State Geologist



POWERTECH (USA) INC.
API ID# 40 047 05089

PowerTech Corp.

SUN #1 LANGE-NEELSON

1980' NSL + 660 WEL.

NESE-21-75-1E

Fall River Co.

Sun Oil Co

Denver, Colo. Phone-266-2181

Surface owner - 1st Nat Bank
Trustee of Nelson-Estate.

Elev: 34-3526

K.B. - 8.5

Permit: 1-27-64

Est. T.D. - 3200 ML

Contractor: - Bourhardt

Feb 1, 1964

Repair on equipment at
Location.

Feb 20, 1964

2916
appart to T.D. of 2941

2886 Madison Top (?)

DST #1 2315-33

30" - 41 hr - 40"

few bubbles & dirt.

Rac. 15' mud.

OSP 15-27

Temp 67°

FP 15-27

HP 1211-1143

oil show at 2318-25

DST #2 2390-2400

32" - 1 hr - 30"

open with gas, flow for 30 min
to fair blue and oil.

Rac 2036, black sulphur
water, slightly foat

OSP 1026-1026

FP 144-884 HP 1341-1242

HP 1341 12:10 Temp 84°

Feb 7, 1964

Spec: Feb 4, 1964

16 of 64

Set 8 3/8" 269 w/175 air

Drilling out from well.

Feb 14, 1964

2333' progressing to DST. glb show.

Log Sample top:

Dak 370

Morrison 710

Sundance 870

Sp. 1186

Mk 1727 (?)

OP 1795 (?)

ML 1840

R. Marker. 2272

Est T.D. 3200 or 50' into Morrison

Will run laterolog &
gamma ray down.

7 3/8" hole.

2nd log

top ml

top sundance.

Dak

50 ml better surface.

2-21-64

Jonston Called at Nite & Said
were about ready to fly.

T.D. 3057

log tops from laterolog & gamma ray

Dak 368

Joh 562

Morrison - 653

Sundance 850

Gypsum Springs 1151

Spanish 1186 OP 1770

Mk. 1760 (?) ML 1842

on ... (?)



- Coal Masher 2271
 2nd Leo 2384
 3rd Leo 2618 (?)
 Madisa 2790

John called at midnite & said
 hoping Madisa should
 have play as it had 23%
 porosity. I said yes & the
 coal plugs were placed Saturday
 2-22-64

25 SA 2977-3057 Madisa
 25 SA 2nd Leo 2360-2440
 25 SA ml 1800-1880
 25 SA. Sandstone top 820-900
 40 SA top Dak 330-460
 25 SA 230-290 R/Sepu.
 10 SA Sugar plug.

2-28-64

Rig zone. pits not filled
 Make up. Does not have
 NESE on it - but guess it OK.

pits filled O.K. & filled
 & ground leveled.

May 12, 64

Sept. 9, 1964

Frank Neigh says OK to
 Release everything on this
 test.

~~July 30~~

WELL; - *Sur #1 Large Nelson*

LOCATION; - *NE SE sec 21, T7S, R1E*

LOGS RECD; -
TOPS; -

GEOLOGIC; - *completion Report (2)
(3-9-64)*

ELECTRIC, FIELD; -
FINAL; - *LL, 2 copies
3-4-64
1 copy RMWLS*

RADIO, FIELD; -
FINAL; - *ionic - GR
(2 copies) 3-7-64
1 copy RMWLS*

OTHERS; -

CUTTINGS RECD; - *3-27-64*

CORES RECD; -

DRILL STEM DATA RECD; - *see
completion report*

CAP PLUG CHECKED; - *OK 2-28-64*

PLUGGING AFFIDAVIT SIGNED; -
*Rec. plugging Rec (form 7) 2-28-64
Rec. form 6 (7-9-64)
Bond released 9-2-64*



Released - 2-22-64

Sum #1 Lance - Nelson

NE, SE, sec 21, T.7S.; R1E
Fall River Co.

elev. 3526.0

2-1-64

Pits not dug: No equip
ment at location.

2-7-64

Spudded 2-4-64 +
set 269' of 8 5/8" surface cry.

2-14-64

Preparing to drill stem test
at 2333' after obtaining oil show

Sp. tips:

Kd - 370

Munnehalte - 1727

Mowea - 710

Opehe - 1795

Sudas - 870

Muhnelma - 1840

Spangil - 1186

Red Mark - 2272

2-20-64

Drilling at 2916

DST #1 2315-33 Rec. 15' drilling mud
 SIP-15-27, FP-15-27, HP-1211-1143
 (oil show in sampler 2318-25) Temp 67°

DST #2 2390-2400 (second fer)

Rec. 2036' black sulphur H₂O, silty gas cut
 SIP 1026-1026, FP 144-984, HP 144-1241
 temp 84°

2-22-64

Plugged

Drilled from 2916-3057, ran LL
 & GR - toxic logs

Taps

Kd-368	Gyp Spmg-1151	2" J-fer - 2384
KL-562	Temp 21-1186	3" " - 2618(?)
Morison-653	Whirlstone-1842	Mudline - 2990
Standard-850	RM - 2271	TD <u>3057</u>

2-28-64

Rig moved from loc.

mud was placed

Pits not filled

5-12-64

Now pits filled



OPERATOR'S TECHNICAL REPORTS / MAPS



WELL COMPLETION REPORT

SUN OIL CO.

#1 LANCE-NELSON ESTATE

NE SE. SEC. 21, T. 7S., R. 1E.

FALL RIVER COUNTY, SOUTH DAKOTA

Eldred D. Johnson
3025 Alma Ave.
Casper, Wyoming
Phone: 234-8568



I N D E X

	<u>Page</u>
SYNOPSIS	1
CHRONOLOGICAL HISTORY	2
BIT RECORD, DEVIATION SURVEYS	4
DRILL STEM TEST DATA, SCHLUMBERGER POROSITY AND WATER SATURATION DETERMINATIONS	5
SAMPLE DESCRIPTION	6
ELECTRIC LOG TOPS	17
PLUGGING RECORD	18



SYNOPSIS

OPERATOR: Sun Oil Co.

WELL: #1 Lance-Nelson Estate

LOCATION: NE SE; 1989 NSL, 660 WEL (not center location)
Sec. 21, T. 7S., R. 1E.
Fall River County, South Dakota

ELEVATION: 3526 Gr., 3535 KB

SPUDDED: February 4, 1964 (9:00 P.M.)

CEASED DRILLING: February 21, 1964 (12:30 P.M.)

COMPLETED: February 22, 1964 (7:00 A.M.)

STATUS: P & A

TOTAL DEPTH: 3057 Driller; 3057 Log

CASING: 8-5/8" surface casing set @ 269 w/175 sacks

HOLE SIZE: 9" from below surface casing to 620'.
8-3/4" from 620' to 802'. 7-7/8" from 802' to T.D.

CONTRACTOR: Barnhart Drilling Co. - Rig #1
Tool Pusher - Lyle Robinson
Drillers - H. H. Wilson, Floyd P. Reed, Sam Rinard

DRILLING MUD: Magnet-Cove Barium Corp.; Low PH Gel-Chemical
Mud Engineers - Morris Carroll, George Brown,
J. Martin

LOST CIRCULATION: Lost circulation for 5 1/2 hours @ 2125'. Lost
approximately 500 bbl. mud.
Lost Circulation while making trip @ 2523. Lost
approximately 200 bbl. mud.

CORING: No cores cut

DRILL STEM TESTS: DST #1 2315-33 (1st Leo (?) Zone)
Rec. 15' drilling mud
DST #2 2390-2400 (2nd Leo)
Rec. 2036' SGC black sulphur water
Johnston Testers Inc.
Test Engineer - Jimmie Hulse; Gillette, Wyo.

LOGS: Schlumberger Well Surveying Corp.
Laterolog from 3057 to 269; Sonic Log-Gamma
Ray Caliper from 3057 to 269
Log Engineer: Ted Campen



SAMPLES: All samples were delivered to American Stratigraphic Co., Casper, Wyoming.

GEOLOGIST RELEASED: February 22, 1964

CHRONOLOGICAL HISTORY

<u>Date</u>	<u>8:00 A.M. Depth</u>	<u>Data</u>
2-4-64	Rigging up	Spudded 9:00 P.M. this date
2-5-64	Drilling surface hole @ 127	Made 187'
2-6-64	Drilling surface hole @ 772	Made 585' Drilled surface hole to 802 @ 9:45 A.M. Made 32'. No water flow was encountered so surface hole was reamed out to 12 1/4" to a depth of 272'. Ran 8-5/8" surface casing to 269' w/175 sax. Plug down @ 4:30 PM this date.
2-7-64	Hippling up	Drilled out cement and cleaned out to 802'. Began drilling new hole @ 5:30 PM this date. Encountered water flow of 10-12 bbl./hr. White @ 900
2-8-64	Trip for bit #4 @ 1102'	Made 220'
2-9-64	Drilling @ 1486'	Made 384'
2-10-64	Drilling @ 1745'	Made 259'
2-11-64	Drilling @ 1942'	Made 197'
2-12-64	Drilling @ 2079'	Made 137' Lost circulation for 5 1/2 hrs. @ 2125'. Lost approximately 500 bbl. mud before regaining circulation.
2-13-64	Drilling @ 2210'	Made 131'
2-14-64	Trip for bit #13 @ 2310'	Made 100'
2-15-64	Pulling DST #1	DST #1 2315-2333. Rec. 15' @ mud, no show.
2-16-64	Trip for DST #2 @ 2400'	Made 90' DST #2, 2390-2400. Rec. 2036' SGC sulph. wtr.
2-17-64	Drilling @ 2438'	Made 88' Lost circulation while making trip @ 2523'. Lost approximately 200 bbl. mud



2-18-64	Drilling @ 2607'	Made 119'
2-19-64	Drilling @ 2752'	Made 145'
2-20-64	Drilling @ 2891'	Made 139'
2-21-64	Drilling @ 3005'	Made 114' Drilled to TD of 3057 @ 12:30 PM this date. Made 52'. Ran Schlumberger Laterolog and Gamma Ray-Sonic-Caliper log from 3057 to 269'.
		TD 3057 driller 3057 Log
2-22-64	P & A	Set 25 sack plug from 2977-3057 across top of Madison. Set 25 sack plug from 2360-2440 across 2nd Leo. Set 25 sack plug from 1800-1880 across top of Minnelusa Set 25 sack plug from 820-900 across top of Sundance. Set 40 sack plug from 330-460 across top of Dakota. Set 25 sack plug from 220-290 in base of surface pipe. Set 10 sack plug with regulation marker in top of surface pipe. Rig released @ 7:00 AM. P & A.

BIT RECORD

<u>Bit No.</u>	<u>Size</u>	<u>Make</u>	<u>Type</u>	<u>Serial #</u>	<u>Depth Out</u>	<u>Footage</u>	<u>Hours Run</u>
1	9	Smith	S5N	Re-Run	620	374	10-1/4
2	8-3/4	HTC	O3C1G	Re-Run	802	132	6-1/2
3	7-7/8	Smith	DT2G	Re-Run	1102	300	12
4	7-7/8	CP	ES2G	14067	1423	321	12-1/4
5	7-7/8	CP	ES2G	15569	1618	195	17-3/4
6	7-7/8	Reed	YT1A	134234	1815	197	15-1/2
7	7-7/8	Reed	YTLR	D34627	1916	101	7-1/4
8	7-7/8	HTC	OWL	39185	2000	84	9
9	7-7/8	Smith	SV2	60727	2038	38	6-1/4
10	7-7/8	HTC	OWC	90482	2162	127	14
11	7-7/8	Reed	YHR	331353	2250	88	15-1/2
12	7-7/8	HTC	OWL	38519	2310	60	11-3/4
13	7-7/8	CP	EHL	10557	2371	61	11-1/2
14	7-7/8	Smith	C2	69423	2461	90	10-3/4
15	7-7/8	Smith	C2	69459	2523	62	9-1/2
16	7-7/8	Reed	YH1	131688	2593	70	10-1/4
17	7-7/8	HTC	W7	35485	2680	87	14-1/4
18	7-7/8	Smith	L4	64483	2757	77	11-1/2
19	7-7/8	CP	EHL	194044	2867	110	14-1/2
20	7-7/8	CP	EHL	12792	2941	74	9-3/4
21	7-7/8	HTC	W7	35478	2997	56	7-3/4
22	7-7/8	Reed	YH	21582	3057	60	5-3/4

DEVIATION SURVEYS

<u>Depth</u>	<u>Deviation</u>	<u>Depth</u>	<u>Deviation</u>
72'	1/4°	1618'	1-1/4°
130'	1/4°	1815'	1°
328'	1/4°	1916'	1-1/2°
474'	3/4°	2000'	1-1/4°
538'	1/2°+	2162'	1-3/4°
620'	1/4°	2310'	1-3/4°
744'	3/4°	2371'	1-3/4°
802'	1/2°	2593'	2-1/4°
994'	1°	2757'	2-1/2°
1102'	3/4°	3057'	3°
1423'	3/4°		



DRILL STEM TEST DATA

DST #1, 2315-2333 (1st Leo (?) Zone)

ISI 30 minutes. Open 1 hour. FSI 40 minutes.

Tool opened with a very slight blow and died

Recovered 15' drilling mud.

ISIP	15#	IFP	15#	IHP	1211#
FSIP	27#	FFP	27#	FHP	1143#

E.H.T. 67°F.

DST #2, 2390-2400 (2nd Leo)

ISI 30 minutes. Open 1 hour. FSI 30 minutes

Tool opened with a good blow for 30 minutes, decreased to fair blow at end of test.

Recovered 2036' slightly gas cut black sulphur water.

ISIP	1026#	IFP	144#	IHP	1341#
FSIP	1026#	FFP	384#	FHP	1242#

E.H.T. 84°F.

Drill stem tests by Johnston Testers, Inc.
Engineer: Jimmie Hulse, Gillette, Wyoming

SCHLUMBERGER POROSITY AND WATER SATURATION DETERMINATIONS

Dakota 450-460

SP = +10 R11 = 35
Δ+ = 115 Rw = 2.4
∅ = 27% Sw = 75-80%

Lakota 590-600

SP = +10 R11 = 50
Δ+ = 115 Rw = 2.5
∅ = 27% Sw = 70%

Sundance 1080-1090

SP = +10 R11 = 48
Δ+ = 100 Rw = 2.4
∅ = 21% Sw = 100%

Converse 1850-1900

SP = +10 R11 = 48
Δ+ = 100 Rw = 2.4
∅ = 21% Sw = 100%

Converse 1970-1980

SP = +20 R11 = 200
Δ+ = 75 Rw = 3.0
∅ = 14% Sw = 90%

Converse 2106-2138

R11 = 30
Δ+ = 84 Rw = .41
∅ = 17% Sw = 61-78%

1st Leo (?) Zone 2318-2325

SP = -10 R11 = 75
Δ+ = 65 Rw = .80
∅ = 11% Sw = 87%

2nd Leo 2400-2420

R11 = 13 Rw = .60 @ 60°
Δ+ = 110 Rw = .38 @ 100°
∅ = 29% Sw = 70%

3rd (?) Leo 2685-2690

SP = +35 R11 = 30
Δ+ = 83 Rw = 5.0
∅ = 20% Sw = 100%

Pahasapa 3030-3040

SP = -45 R11 = 200
Δ+ = 85 Rw = 4.0
∅ = 22% Sw = 85%



SAMPLE DESCRIPTION

Samples were examined under the binocular microscope with 9X eyepiece and 1X, 2X, and 3X objective lenses during the drilling of the well, February, 1963. 30' samples were caught from surface to 600'. 10' samples were caught from 600' to T.D. The samples description is condensed from the well-site description and adjusted to the E-Log depths.

<u>From</u>	<u>To</u>	<u>Feet</u>	<u>Description</u>
Surface	45	45	Stream gravel; red, pink, orange chert and quartz granules and pebbles, unconsolidated.
45	260	215	Shale, very dark gray to black, firm to hard, slightly micaceous, bentonitic to siliceous, silty. Trace of dark brown, hard, slightly calcareous siltstone in interval 150-180. Scattered traces of calcite and selenite fragments.
260	270	10	Sandstone, medium gray, very fine grained, sub-angular, poor sorting, clay filled, very heavily glauconitic, poor P & P, no show.
270	366	96	Shale, very dark gray to black, firm to hard, some soft, silty, slightly micaceous, bentonitic in part.
<u>Dakota sandstone</u>			366 (+3169) log
366	400	34	Sandstone, white-light gray, very fine grained, sub-angular, clay filled, fairly friable, poor P & P, no show, interbedded with shale, very dark gray to black, firm to hard, some soft, silty, micaceous.
400	425	25	Shale, as above, very dark gray to black, with some interbedded streaks of sandstone, as above, white, hard and calcareous in part.
425	450	25	Sandstone, white, fine to very fine grained, sub-angular, hard, calcareous in part, poor P & P, interbedded with shale, as above, very dark gray to black, silty, also some medium gray, smooth, somewhat waxy, in part variegated with brown to tan shale.
450	500	50	Sandstone, white, fine to very fine grained, sub-angular, glauconitic in part, fair P & P to very hard and tight. Spotty bright yellow fluorescence with fair to good cut in sample 450-480. Some interbedded medium gray to green claystone, waxy, smooth, with floating sand grains, and some scattered gray to black silty shale, as above. Abundant brown siderite pellets in sample 450-480. Scattered pyrite and very abundant loose very coarse quartz grains at base of interval.



<u>From</u>	<u>To</u>	<u>Feet</u>	<u>Description</u>
500	562	62	Sandstone, white to gray, medium to very coarse grained, conglomeritic, sub-rounded to sub-angular, extremely friable, being mostly loose grains in samples, no show. Some traces of interbedded shale, variegated medium gray, lavender, olive green, trace pink, smooth, somewhat waxy, some light green shale with floating sand grains.
<u>Lakota sandstone</u>			562 (+2973) log
562	600	38	Sandstone, white to gray, fine to coarse grained, conglomeritic, sub-rounded to sub-angular, poor sorting, extremely friable, excellent P & P, some scattered fairly bright yellow fluorescence, poor to fair cut. Some interbedded shale, as above, variegated, purple, gray, green, rust-brown, waxy.
600	653	53	Sandstone, white to fine to coarse grained, conglomeritic, poor sorting, sub-rounded, extremely friable, excellent P & P, slight trace of stain, spotty bright yellow fluorescence, poor cut at base of interval. Some interbedded shale, variegated as above, but mostly gray and lavender.
<u>Morrison formation</u>			653 (+2882) log
653	690	37	Shale, medium gray, firm, smooth and waxy, some silty, with some variegated shale, as above, and sandstone white, fine to very coarse grained, conglomeritic, sub-rounded, poor sorting, very friable, good to excellent P & P, some scattered fairly bright yellow fluorescence with poor to fair cut at base of interval. At top of interval is some yellow to yellow-brown sandstone, very fine grained, sub-rounded to sub-angular, micaceous, hard to friable, calcareous, Scattered pyrite fragments throughout interval.
690	720	30	Shale, as above, medium to dark gray, some variegated, with some sandstone, white, fine to very coarse grained, conglomeritic, sub-rounded, very friable, good to excellent P & P, some scattered bright yellow fluorescence with fair to good cut at top of interval. Trace white, fine grained, fairly hard, clay filled sandstone. Slight trace hard, brown, silty, crystalline limestone. Some very coarse red and yellow chert grains.



<u>From</u>	<u>To</u>	<u>Feet</u>	<u>Description</u>
720	750	30	Shale, medium to dark gray, some variegated, firm, smooth, waxy and sandstone, conglomeratic, as above, very friable, and some white to light gray, fine to very fine grained, sub-angular to sub-rounded, clay filled, friable to hard and tight, slightly micaceous, slightly glauconitic in part, no show. Fairly abundant pyrite at top of interval.
750	780	30	Shale, medium to dark gray and greenish gray, firm, blocky, fairly smooth, somewhat waxy, becoming silty in part. Some medium to dark gray and dark grayish brown, hard, silty, very argillaceous limestone, increasing toward base of interval. Scattered traces of calcite fragments. Slight trace of pyrite.
780	850	30	Limestone, light to medium gray, some gray-green, hard, very argillaceous, grading to and interbedded with shale, medium to dark gray, calcareous to very calcareous, silty in part, mostly smooth and waxy. Some bright green shale, smooth waxy, some with floating sand grains at bottom of interval some very argillaceous limestone shows fairly bright yellow fluorescence but no cut. Also at base of interval is some sandstone, white to bright green, very fine grained, sub-angular to sub-rounded, friable, calcareous, clay matrix, fair to good P & P, some dull to fairly bright yellow fluorescence, no cut.
<u>Sundance formation</u>			850 (+2685) log
850	880	30	Shale, medium gray to grayish-brown, soft, silty, some carbonaceous inclusions, also bright green waxy shale, interbedded with sandstone, white to medium gray and green, very fine grained, sub-rounded, clay matrix, silty fairly friable, becoming glauconitic, fair to good P & P, no show. Some hard, gray, very argillaceous limestone at top of interval.
880	920	40	Shale, medium to dark gray and grayish-brown, soft, silty, calcareous in part, also light to dark, soft lavender shale, slightly silty, slightly calcareous in part. Some interbedded sandstone, light gray to green, very fine grained, sub-rounded, glauconitic, clay matrix, calcareous, hard to soft and friable, no show.



<u>From</u>	<u>To</u>	<u>Feet</u>	<u>Description</u>
920	970	50	Shale, variegated, medium gray, green, maroon, lavender, red, some olive green, firm to soft, silty to waxy, calcareous, interbedded with sandstone, as above, gray to green, very fine grained, sub-rounded, glauconitic, calcareous, no show.
970	990	20	Siltstone, rust-red, sandy, soft, shaly and sandstone, rust-red, very fine grained, sub-angular to sub-rounded, very silty, friable, no show. Some variegated shale, as above.
990	1050	60	Sandstone and siltstone, rust-red, as above, and sandstone, light to medium gray and gray green, very fine grained, sub-angular to sub-rounded, glauconitic slightly calcareous, friable, no show. Some interbedded shale, variegated as above, becoming predominately gray, soft to firm, smooth and waxy to silty. Some bright green waxy shale with floating sand grains.
1050	1100	50	Sandstone, light gray to green, some very light tan, very fine grained, sub-angular to sub-rounded, clay filled in part, becoming glauconitic at base of interval, calcareous, friable, fair to good P & P, no show. Some interbedded shale, gray as above, some variegated.
1100	1152	52	Shale, medium to dark gray, firm to soft, slightly silty, calcareous, with some light green and lavender variegated shale, as above.
<u>Gypsum Spring formation</u>			1152 (+2383) log
1152	1186	34	Shale, medium to dark gray and grayish-brown, some green and lavender, soft, slightly silty, calcareous. Some scattered sandstone, white, fine to very fine grained, friable, calcareous, no show. (The above description of the Gypsum Spring is what was observed in the samples. From the drilling time, however, it would appear that the interval is made up predominantly of gypsum or anhydrite. This interval drilled at the rate of .25 minutes per foot as compared to 1.45 minutes per foot both immediately above and below the Gypsum Spring. The log also looks like gypsum, especially since the caliper shows a washed out zone at this interval.)



<u>From</u>	<u>To</u>	<u>Feet</u>	<u>Description</u>
<u>Spearfish formation</u>			1186 (+2349) log
1186	1290	104	Siltstone, brick red, becoming bright brick red in lower 2/3 of interval, sandy, shaly in part, slightly calcareous with interbedded dark brick red shale, silty, slightly calcareous. Trace of white crystalline to earthy anhydrite near base of interval.
1290	1350	60	Siltstone, bright brick red, firm to hard, sandy, calcareous, becoming anhydritic, and some shale, brick red to reddish-brown, hard, silty, slightly calcareous. Some traces of anhydrite, white, soft, sucrose to earthy, some clear and crystalline.
1350	1450	100	Siltstone, and shale, as above, becoming only slightly calcareous, interbedded with thin stringers of anhydrite, white, soft, sucrose to earthy, some crystalline to fibrous.
1450	1500	50	Siltstone, bright red-orange, becoming darker in lower 1/2 of interval, sandy, hard, slightly calcareous to non-calcareous, anhydritic, and some brick-red, silty shale, as above, and some interbedded anhydrite, as above.
1500	1600	100	Anhydrite, white, firm to hard, brittle, sucrose to crystalline, also soft and earthy, interbedded with siltstone and shale, as above, non-calcareous.
1600	1620	20	Anhydrite, white, firm to hard, sucrose to crystalline, brittle.
1620	1640	20	Dolomite, white, light gray, pink, light purple, very fine to microcrystalline, hard, brittle, dull to light yellow fluorescence, no cut. Some interbedded siltstone bright, red-orange, sandy, anhydritic.
1640	1680	40	Interbedded siltstone, bright red-orange as above, and dolomite, white, pink, purple, fine to microcrystalline, silty in part, light to dull yellow fluorescence, no cut.
1680	1726	46	Siltstone, as above, red-orange, sandy anhydritic. Scattered traces of dolomite and anhydrite, as above.

<u>From</u>	<u>To</u>	<u>Feet</u>	<u>Description</u>
<u>Minnekahta limestone</u>			1726 (+1809) log
1726	1764	38	Limestone, white to gray, pink, hard, brittle, very fine to microcrystalline, dull to light yellow fluorescence, no cut, grading to dolomite pink to light purple, hard, brittle, microcrystalline, dull to light yellow fluorescence, no cut.
<u>Opesche shale</u>			1764 (+1771) log
1764	1800	36	Dolomite, white-light gray, pink, hard, brittle, microcrystalline, with some traces of limestone as above, dolomitic, dull yellow fluorescence, no cut, interbedded with siltstone, red-orange to brick-red, sandy, anhydritic and some brick-red silty shale.
1800	1838	38	Siltstone, red-orange to brick-red, firm, sandy, dolomitic, shaly in part, with some scattered dolomite, as above, and anhydrite, white, sucrose.
<u>Minnelusa formation</u>			1838 (+1697) log
1838	1895	57	Sandstone, pink to white, fine to medium grained, sub-rounded to sub-angular, well sorted, friable, good to excellent P & P, no show. Toward base of interval sandstone becomes dark pink to red, slightly harder, clay filled, dolomitic, poor to fair P & P. Trace of interbedded dolomite, as above, at top of interval.
1895	1960	65	Dolomite, white, pink, light gray, trace of purple, hard, brittle, fine to microcrystalline, sandy in part, very slight trace of brown stain, dull yellow fluorescence, no cut. Some interbedded shale, dark gray to black, and grayish-green, firm to soft, silty to smooth and somewhat waxy, sandy in part.
1960	1990	30	Sandstone, pink to red-orange, some white, fine grained, sub-angular to sub-rounded, well sorted, anhydrite filled, friable, poor to fair P & P, some good P & P, no show. Abundant anhydrite, white, soft to very soft, granular to earthy.
1990	2030	40	Limestone, mottled medium to dark gray, hard, fine to microcrystalline, some medium crystalline, silty to sandy, becoming dolomitic and grading to dolomite, dull yellow fluorescence, no cut. Some scattered shale, medium gray to black, also lavender and green, smooth, fairly soft, somewhat waxy, with some floating sand grains. Some scattered soft, white, earthy to sucrose anhydrite.



<u>From</u>	<u>To</u>	<u>Feet</u>	<u>Description</u>
2030	2060	30	Dolomite, mottled medium to dark gray, some light gray, hard, liney, brittle, very fine to fine crystalline, scattered dull fluorescence, no cut. Some interbedded limestone at base of interval, very fine to microcrystalline, hard, brittle, silty to sandy, dull fluorescence, no cut.
2060	2070	10	Sandstone, pink to purple, fine to very fine grained, sub-angular to sub-rounded, clay filled, dolomitic, hard and brittle to friable, poor to fair P & P, no show, with dolomite, white to pink, some purple, very fine to microcrystalline, hard, light yellow fluorescence, no cut. Scattered coarse yellow chert grains.
2070	2080	10	Siltstone, bright red-orange, hard, sandy, dolomitic, with some bright red-orange silty shale, and abundant very soft, white, earthy anhydrite.
2080	2100	20	Shale, medium to dark gray, some green, firm, smooth to silty, with some anhydrite, soft to firm, sucrose to earthy. Some sandstone, as above.
2100	2160	60	Sandstone, white, fine to medium grained, some very fine grained, sub-rounded, well sorted, anhydritic in part, friable to extremely friable, good to excellent P & P, no show, with some interbedded shale, medium gray to grayish-green, some light green, firm, smooth and waxy to silty.
2160	2210	50	Dolomite, white to gray, pink, purple, very fine to microcrystalline, hard, brittle, scattered dull to light yellow fluorescence, no cut. Some interbedded white, dolomitic anhydrite at top of interval, very fine crystalline, firm to hard. Scattered white chert grains.
2210	2230	20	Sandstone white, fine to medium grained, sub-angular to sub-rounded, well sorted, very friable, anhydritic, fair to good P & P, no show, and dolomite, as above, hard, microcrystalline, fair light yellow fluorescence, no cut. Some soft white earthy anhydrite.
2230	2272	42	Dolomite, white to light gray, some pink and purple, very fine to microcrystalline, hard, liney, light to dull yellow fluorescence, no cut, with interbedded shale, gray to greenish gray, soft, silty to waxy. Some scattered streaks of sandstone, white to pink and light purple, fine grained, dolomitic, anhydritic, firm to somewhat friable, no show. Some very soft white, earthy anhydrite, and scattered yellow chert grains.



<u>From</u>	<u>To</u>	<u>Feet</u>	<u>Description</u>
<u>"Red Marker"</u>			2272 (+1263) log
2272	2280	8	Shale, red, soft, flaky, smooth with silky metallic luster.
2280	2318	38	Dolomite, white to gray, pink, very fine to microcrystalline, hard, trace of medium brown stain, trace faint fluorescence, no cut, with some interbedded sandstone, white to pink and purple, fine to medium grained, sub-angular to sub-rounded, dolomitic, anhydritic, hard to fairly friable, poor P & P, no show. Some sandstone at base of interval, white to pink, fine to medium grained, sub-rounded to sub-angular, well sorted, friable, dolomitic in part, some faint yellow fluorescence, <u>trace very faint cut.</u>
2318	2333	15	Dolomite, dark gray, fine crystalline, hard to somewhat porous, shaly in part, scattered <u>dark brown stain, fairly bright yellow gold fluorescence, good bright yellow gold cut,</u> with some sandstone, white fine grained, sub-rounded, dolomitic in part, hard to friable with fairly abundant loose grains, fairly even light brown stain, pale yellow fluorescence, faint light yellow cut.
<u>Circulated samples @ 2333'</u>			Dolomite, as above, more light brown stain, and sandstone, as above, light stain, pale fluorescence, more abundant loose grains in sample. <u>Entire sample gives fair to bright light yellow cut.</u>
<u>D.S.T. #1, 1st Leo (?) Zone 2315-2333 (See page 5 for data on DST #1)</u>			
2333	2384	51	Shale, dark to very dark gray, some grayish-green, firm, waxy, silty in part, with some interbedded dolomite, white to gray, tan, very fine to microcrystalline, hard. Some stringers of sandstone, white fine to very fine grained, hard, dolomitic, poor P & P, no show.
<u>2nd Leo Sandstone</u>			2384 (+1151) log
2384	2390	6	Sandstone, medium gray, very fine grained, sub-angular, hard, dolomitic, poor P & P, no show, becoming softer, somewhat friable, with slight fluorescence, no cut.

<u>From</u>	<u>To</u>	<u>Feet</u>	<u>Description</u>
2390	2400	10	(Circulated 30 minutes for samples) Sandstone, white, fine grained, sub-rounded, well sorted, friable, good P & P, fair light brown stain, even fairly bright light yellow fluorescence, fair to good cut. Sulphur odor in sample.
<u>DST #2. 2nd Leg. 2390-2400 (See page 5 for data on DST #2)</u>			
2400	2430	30	Sandstone, white, fine to medium grained, sub-rounded, well sorted, friable to extremely friable, good to excellent P & P, even light brown stain at top of interval becoming spotty, fairly bright to dull yellow fluorescence, good to poor cut.
2430	2460	30	Shale, dark to very dark gray, some greenish gray, firm, waxy to silty, with dolomite, gray to pink, tan, fine to microcrystalline, hard, limy, silty in part. Some interbedded sandstone, white, fine to medium grained, sub-rounded, friable, to very friable, good to excellent P & P, slight trace light brown stain, faint to fair light yellow fluorescence, trace fair to good cut. Scattered traces hard, black, brittle, silty shale.
2460	2500	40	Dolomite, tan to dark gray, fine crystalline, hard, limy, silty to sandy in part, with interbedded medium to dark gray, firm waxy to silty shale and, very hard black, brittle, silty shale. Some traces of interbedded sandstone, white to light gray, fine to very fine grained, sub-angular to sub-rounded, hard, dolomite matrix, poor P & P, very slight trace of fluorescence, no cut.
2500	2515	15	Sandstone, white, fine to very fine grained, sub-rounded to sub-angular, hard and dolomitic in part, becoming friable, with good P & P, some very light brown stain, faint yellow fluorescence, very slight trace of cut, sulphur odor.
2515	2580	65	Dolomite, gray to dark gray, fine to very fine crystalline, hard, silty to sandy, limy and anhydritic in part, with interbedded shale, medium to dark gray, firm to hard, with some scattered shale, black, very hard, brittle, silty. Some scattered sandstone, white to light gray, fine to very fine grained, sub-rounded to sub-angular, hard and dolomitic to friable, no P & P to good P & P, trace fair light yellow fluorescence, no cut.



<u>From</u>	<u>To</u>	<u>Feet</u>	<u>Description</u>
2580	2618	38	Dolomite, dark gray to tan, hard, silty to sandy, and sandstone, white to gray, fine grained, sub-rounded to sub-angular, hard, dolomitic, some friable, poor to fair P & P, some scattered even brown stain, very poor to fair yellow fluorescence, no cut.
<u>3rd Leo (?) sandstone</u>			2618 (+917)
2618	2650	32	Sandstone, white to gray, very fine grained, sub-angular to sub-rounded, dolomitic, friable, poor to fair P & P, dull to fair yellow fluorescence, no cut, with dolomite, tan, gray, white, fine to microcrystalline, hard, limey, sandy, dull to fair yellow fluorescence, no cut.
2650	2680	30	Sandstone, white to light gray, very fine to fine grained, sub-rounded, very calcareous, hard to friable, poor to fair P & P, poor light yellow fluorescence, no cut, with some interbedded limestone, white, hard, microcrystalline, very sandy, and dolomite, tan, gray, hard, microcrystalline, very limey, fair light yellow fluorescence, no cut. Abundant very soft, white, earthy anhydrite near top of interval.
2680	2700	20	Sandstone, white, fine to very fine grained, sub-rounded to sub-angular, calcareous to very calcareous, hard to friable, poor to fairly good P & P, no fluorescence on porous sand, to fairly bright light yellow fluorescence on hard and tight sand, no cut. Some dolomite, dark gray to brown, hard, very fine crystalline, silty in part, somewhat limey. Scattered red, yellow, orange and white chert fragments.
2700	2730	30	Shale, dark maroon to red, soft to firm, silty, some green shale inclusions, interbedded with sandstone, white to light gray, very fine grained, sub-rounded to sub-angular, hard and dolomitic to friable and very calcareous, anhydritic, no P & P to fairly good P & P, very faint fluorescence, no cut. Abundant anhydrite at top of interval, white, soft and earthy to firm and sucrose.
2730	2760	30	Sandstone, white to gray and greenish gray, with maroon speckling, very fine grained, sub-angular to sub-rounded, calcareous to very calcareous, firm to friable, scattered faint fluorescence, no cut, with interbedded dolomite, tan to gray, microcrystalline, hard, fairly bright fluorescence, no cut, and some limestone, white, very fine to microcrystalline, hard.

#1 L. e-Nelson Estate
NE SE Sec. 21-7S-1E
Fall River County, S.D.

<u>From</u>	<u>To</u>	<u>Feet</u>	<u>Description</u>
2760	2795	35	Shale, variegated red, green, maroon, lavender, soft to firm, silty, sandy in part and calcareous in part, interbedded with limestone, white to light gray and tan, very fine to microcrystalline, hard, shaly in part. Some scattered yellow and orange chert fragments.
2795	2848	53	Limestone, white, light gray, very light pink, light lavender, very fine to microcrystalline, hard to very hard, with abundant orange, tan, and lavender chert, some interbedded shale, variegated gray to dark gray, green, red and green mottled, firm and waxy to soft and silty. Some soft, white, earthy anhydrite in upper half of interval.
2848	2870	22	Sandstone, white to tan, fine to medium grained, sub-angular, calcareous, very conspicuous bright green glauconite grains, hard to friable, poor P & P, no show, interbedded with variegated shale and tan, hard limestone, as above.
2870	2905	35	Limestone, light tan to light gray, some lavender, and very light green, very fine to microcrystalline, trace of floating sand grains, hard, shaly in part, dolomitic in upper half of interval, some pale yellow fluorescence, no cut. Fairly abundant scattered yellow, orange, red, and some white chert.
2905	2917	12	Anhydrite, white, very soft, earthy and abundant chert, mottled scarlet and light gray.
2917	2965	48	Limestone, light tan to light gray, fine to very fine crystalline, hard, some lithographic, very hard and siliceous, with some interbedded shale, variegated, gray, red, purple, firm smooth, somewhat waxy. Scattered, chert, red, gray, orange, yellow. Bryozoan (?) fragment in sample 2930-40.
2965	2989	24	Shale, variegated red, gray, green, purple, red-orange, soft, silty to sandy, anhydritic in part. Some limestone, as above, light tan to light gray, hard. Trace purple dolomitic limestone with floating sand grains.



<u>From</u>	<u>To</u>	<u>Feet</u>	<u>Description</u>
<u>Pahasapa limestone</u>			2989 (+546) log
2989	3057	68	Limestone, white to light gray, some light tan, becoming pink at base of interval, fine to very fine crystalline, some traces medium to coarse crystalline, firm brittle, some soft and earthy. Some limestone has very fine purple speckling.

Circulated for logs @ 3057

30 min. circulation	Limestone, white to light gray and light pink, fine to very fine crystalline, some medium to coarse crystalline and darker pink, firm to hard, brittle. Trace coarse white calcite rhombs.
1 hour circulation	Limestone, as above, white to light gray and pink, trace tan, fine to very fine crystalline, trace medium to coarse crystalline, fairly hard, brittle. Fairly abundant variegated shale cavings.
1½ hour circulation	Limestone, as above. Sample mostly cavings.
T.D. 3057 Driller (+478) 3057 Log (+478)	Drilling time was kept on an Eastman Star drilling time recorder and the original chart was delivered to the Sun Oil Co., district office in Casper, Wyoming.

ELECTRIC LOG TOPS

<u>Formation</u>	<u>Depth</u>	<u>Datum (K.B.)</u>
Dakota sandstone	366	+3169
Lakota sandstone	562	+2973
Morrison formation	653	+2882
Sundance formation	850	+2685
Gypsum Spring formation	1152	+2383
Spearfish formation	1186	+2349
Minnekahta limestone	1726	+1809
Opeche shale	1764	+1771
Minnelusa formation	1838	+1697
"Red Marker"	2272	+1263
2nd Leo sandstone	2384	+1151
3rd Leo (?) sandstone	2618	+ 917
Pahasapa limestone	2989	+ 546
T.D.	3057	+ 478



PLUGGING RECORD

Set 25 sack plug across top of Pahasapa from 2977-3057.
Set 25 sack plug across 2nd Leo from 2360-2440
Set 25 sack plug across top of Minnelusa from 1800-1880.
Set 25 sack plug across top of Sundance from 820-900.
Set 40 sack plug across top of Dakota from 330-400.
Set 25 sack plug in base of surface pipe from 220-290.
Set 10 sack plug with regulation marker in top of surface pipe.

ADMINISTRATIVE / SUNDRY REPORTS



STATE PUB. CO., PIERRE

S. Dak. Oil & Gas Board
FORM 7

PLUGGING RECORD

Operator Sun Oil Company		Address P. O. Box 1798, Denver, Colorado		
Name of Lease Lance-Nelson Estate		Well No. 1	Field & Reservoir Wildcat	
Location of Well NE SE Sec. 21-7S-1E		Sec-Twp-Rge or Block & Survey		County Fall River
Application to drill this well was filed in name of Sun Oil Company	Has this well ever produced oil or gas no	Character of well at completion (initial production): Oil (bbbls/day) Gas (MCF/day) Dry? - - X		
Date plugged: 2-22-64	Total depth 3057'	Amount well producing when plugged: Oil (bbbls/day) Gas (MCF/day) Water (bbbls./day) - - -		
Name of each formation containing oil or gas. Indicate which formation open to well-bore at time of plugging	Fluid content of each formation	Depth interval of each formation	Size, kind & depth of plugs used indicate zones squeeze cemented, giving amount cement.	
None				

CASING RECORD

Size pipe	Put in well (ft.)	Pulled out (ft.)	Left in well (ft.)	Give depth and method of parting casing (shot, ripped etc)	Packers and shoes
8-5/8"	269	None	269	-	Surface Casing Remains in hole

Was well filled with mud-laden fluid, according to regulations? **yes** Indicate deepest formation containing fresh water.
Unknown (possibly the Pahasapa Zone ?)

In addition to other information required on this form, if this well was plugged back for use as a fresh water well, give all pertinent details of plugging operations to base of fresh water sand, perforated interval in fresh water sand, name and address of surface owner, and attach letter from surface owner authorizing completion of this well as a water well and agreeing to assume full liability for any subsequent plugging which might be required.

USE REVERSE SIDE FOR ADDITIONAL DETAIL

Executed this the 24th day of February, 19 64

State of Colorado Signature of Affiant Div. Supt. - Oper. Dept. *W. J. Turner*

County of Denver

Before me, the undersigned authority, on this day personally appeared W. J. Turner known to me to be the person whose name is subscribed to the above instrument, who being by me duly sworn on oath states, that he is duly authorized to make the above report and that he has knowledge of the facts stated therein, and that said report is true and correct.

Subscribed and sworn to before me this 24th day of February, 19 64

SEAL My Commission expires July 9, 1966

My commission expires _____ Notary Public in and for J. L. Jester, Notary Public in and for the _____ City and County of Denver, Colorado

Approved *Sept 2-1964* Date DO NOT WRITE BELOW THIS LINE OIL AND GAS BOARD OF THE STATE OF SOUTH DAKOTA Secretary

See Instructions On Reverse Side

*Approved for release of bond
Kenny W. Lugo
cc: Sun Oil Co.
9-5-64*



INSTRUCTIONS

File 3 copies of this form with Secretary, Oil and Gas Board, Pierre.

Our CasPer Office will submit copies of all logs run, complete well history along with other pertinent information in the near future.

Log Tops:

Dakota	366
Lakota	562
Morrison	653
Sundance	850
Gypsum Springs	1152
Spearfish	1186
Minnekahta	1726
Opeche	1764
Minnelusa	1838
Red Marker	2272
Amsden	2848
Pahasapa	2989
	3057' TD

S. Dak. Oil & Gas Board
FORM 6

STATE PUB. CO., PIERRE

SUNDRY NOTICES AND REPORT ON WELLS		FARM OR LEASE NAME Lance - Nelson
		WELL NO. 1
<input type="checkbox"/> OIL WELL <input type="checkbox"/> GAS WELL <input type="checkbox"/> ----- <input checked="" type="checkbox"/> DRY		FIELD AND POOL, OR WILDCAT Wildcat
OPERATOR Sun Oil Company		NO. ACRES IN LEASE 40
ADDRESS P.O. Box 1798, Denver, Colorado		40 ¼ ¼ SEC. TWP. RGE.
LOCATION (In feet from nearest lines of section or legal subdivision, where possible) 1980 NSL and 660 WEL NE SE Sec. 21 - 7S - 1E		NE SE Sec. 21-7S-1E
ELEVATIONS (D.F., R.K.B., R.T., GRD., etc.; how determined) 3526.0 Grd.		COUNTY Fall River
INDICATE BELOW BY CHECK MARK NATURE OF REPORT, NOTICE OR OTHER DATA		
NOTICE OF INTENTION TO:		SUBSEQUENT REPORT OF:
TEST WATER SHUT-OFF <input type="checkbox"/>	SHOOT OR ACIDIZE <input type="checkbox"/>	WATER SHUT-OFF <input checked="" type="checkbox"/>
FRACTURE TREAT <input type="checkbox"/>	REPAIR WELL <input type="checkbox"/>	FRACTURE TREATMENT <input type="checkbox"/>
MULTIPLE COMPLETE <input type="checkbox"/>	PULL OR ALTER CASING <input type="checkbox"/>	SHOOTING OR ACIDIZING <input type="checkbox"/>
ABANDON <input type="checkbox"/>		REPAIRING WELL <input type="checkbox"/>
		ALTERING CASING <input type="checkbox"/>
(Note: Report results of multiple completion on Well Completion or Recompletion and Log Form--Form 4)		

DESCRIBE PROPOSED OR COMPLETED OPERATIONS (Clearly state all pertinent details, and give pertinent dates, including estimated date of starting any proposed work)

Subsequent report of cleared location:

This well was P & A 2-22-64 and the pits have been filled and leveled and location has been cleaned up and the well site is now ready for final abandonment, inspection and approval.

I hereby certify that the foregoing, as to any work or operation performed is a true and correct report of such work or operation.

SIGNED W. J. Turner TITLE Div. Supt. - Oper. Dept. DATE 7-1-64

DO NOT WRITE BELOW THIS LINE

Approved July 7, 1964 OIL AND GAS BOARD OF THE STATE OF SOUTH DAKOTA
Date

CONDITIONS, IF ANY: Alma Larson, Asst. Secretary

See Instructions On Reverse Side



OB: Sun Oil Co
7-8-64

CORRESPONDENCE



POWERTECH (USA) INC.

47 of 64

AUG 24 1964



SOUTH DAKOTA
STATE GEOLOGICAL SURVEY

SCIENCE CENTER
University of South Dakota Campus
VERMILLION 57069

Phone 624-4471
Western Field Office
Belle Fourche, South Dakota
August 21, 1964

DUNCAN J. MCGREGOR
Director and State Geologist
MERLIN J. TIPTON
Assistant State Geologist

Dr. Duncan McGregor
State Geologist
Vermillion
South Dakota

RE Sun #1 Lance-Nelson
NE $\frac{1}{4}$ SE $\frac{1}{4}$ -21-7S-1E
Fall River County, South Dakota
Permit No. 356

Dear Duncan:

The six months confidential period on information from the above test has now terminated and all information may be released.

Sincerely,

Earl Cox
Engineering-Petroleum Geologist

EC:cr

DJ
Send form 6 + 7 to
Duncan for signing
DJ

August 10, 1964

Mr. Earl J. Cox
State Geological Survey
Box 208
Belle Fourche, South Dakota

Dear Earl:

Please find enclosed the Sonic Log and Laterolog for
Sun Lance #1 Nelson, Fall River County, Sec. 21-7S-1E.

Sincerely yours,

(Mrs.) Donna Jean Hedges
Administrative Assistant

For the State Geologist

Enclosures

MAY 18 1964



SOUTH DAKOTA
STATE GEOLOGICAL SURVEY

SCIENCE CENTER
University of South Dakota Campus
VERMILLION 57009
Phone 624-4471

DUNCAN J. MCGREGOR
Director and State Geologist
MERLIN J. TIPTON
Assistant State Geologist

Western Field Office
Belle Fourche, South Dakota
May 15, 1964

Dr. Duncan McGregor
State Geologist
Science Center
Vermillion, South Dakota

Dear Duncan:

Re: Sun #1 Lance-Nelson
NE $\frac{1}{4}$ SE $\frac{1}{4}$ -21-7S-1E
Fall River County, South
Dakota
Permit #356

As shown by the attached Scout report, the above location meets our requirements.

If your office has received the samples, and two copies each of the sample descriptions, two drill stem tests and the logs (laterolog, gamma ray sonic), the bond can be released.

As information on this test is Confidential, both sets of records should be kept at Vermillion until August 22, 1964, when the Confidential period ends.

You may wish to wait until August 22, before recommending the bond released.

Sincerely,

Earl Cox
Engineering-Petroleum Geologist

EC:cr

Enc



March 27, 1964

Mr. Fred McCotter
American Stratigraphic Company
17 North 31st Street
Billings, Montana

Dear Mr. McCotter:

We received the samples in good shape yesterday
from the following wells:

Cities Service #1 Carl Wagner
NW NW 13-5N-29E
Stanley County, South Dakota

Cities Service #1-A Phipps
NW SW 4-2S-23E
Jackson County, South Dakota

Sun Oil Company #1 Lance-Nelson
21-7S-1E
Fall River County, South Dakota

Thank you very much.

Sincerely yours,

Merlin J. Tipton
Assistant State Geologist

MJT:jmd

MAR 12 1964



SOUTH DAKOTA
STATE GEOLOGICAL SURVEY

SCIENCE CENTER
University of South Dakota Campus
VERMILLION 57000
Phone 624-4471

DUNCAN J. McGREGOR
Director and State Geologist
MERLIN J. TIPTON
Assistant State Geologist

Belle Fourche, South Dakota
March 11, 1964

Dear Duncan,

I have your March 10 letter ~~XX~~ with the mention that Frank Neighbor wants the logs on the Sun #1 Lance-Nelson kept confidential.

The Rules, page 3#42, state that all records shall be kept ~~XXXX~~ confidential for six months if requested in writing by the owner.

I am ~~XX~~ always careful to check with the geologist, engineer, or operator, to see if information I obtain when scouting is confidential. Even if no letter has been written, if I am verbally asked to keep the information confidential, I treat it as such, and so mark the scout sheets.

The geologist on the Sun #1 Lance-Nelson test told me several times it was not a tite hole. Sun themselves gave out the sample tops and DST results to Rineharts. However, now that Sun has changed their mind on this, we are obligated to hold the information until August 21, 1964, unless Sun approves the release before that. Neighbor seems to want only the mechanical logs kept confidential, but to be on the safe side I suppose the whole file should be considered confidential. Under the circumstances, any information we might have released prior to Neighbors letter cannot be considered a violation.

The method followed in the past seems to have worked satisfactorily and we have not had any hard feelings or misunderstandings about this to my knowledge. I believe we would get adverse reactions from the oil industry if we made it a policy not to release any information for six months on "non Confidential" tests.

Sincerely,

Earl Cox

March 10, 1964

Mr. Earl Cox
State Geological Survey
P. O. Box 208
Belle Fourche, South Dakota

Dear Earl:

I just received your two memos telling us (1) that you are about to make your move, and (2) the fact that you are getting together with Mr. Hanson about pictorial coverage on your big article on petroleum in South Dakota. Both of these are very good, and I feel that this will materially improve not only the physical space of the Geological Survey in our Western Field Office, but certainly will get the meaning and worth of our organization before the public.

I just got a letter from Frank Neighbor relative to the Sun Oil Company Lance Nelson Estate #1, in which he sent me copies of the logs. He wrote a P. S., saying that he wanted these logs kept confidential as they have not released them to date. I note on some of the scout reports that information you submitted on the Sun Wells carried no confidential word at the top. I was wondering if this were an oversight, or if they have actually waited until now before they declared it confidential. I am wondering if we should adopt a policy that all records we get from these oil companies are held confidential for the six-month period from close of operation. On the other hand, I realize this may hold up getting information out, particularly if the company doesn't mind if it is released. This presents a bit of a problem, because since they have not seen fit to mark the information you got for scout confidential, we may have given out some information that we shouldn't have.

You might ponder this and give me your ideas on what to do about it.

Sincerely yours,

Duncan J. McGregor
State Geologist

DJM:jmd

March 10, 1964

Mr. Frank Neighbor
District Exploration Manager
411 Petroleum Building
P. O. Box 1732
Casper, Wyoming

Dear Frank:

Reference is made to your letter of March 5, 1964, in which you attached a P. S., requesting that we keep the logs confidential until released by you.

This letter is to inform you that because of your request, we have so placed your logs in confidential file, and they will remain there for six months from the date of completion of the Lance-Nelson Estate #1 well.

Seeing your signature at the bottom of the letter made me feel homesick for Salt Lake City. You may or may not remember me, but back in the early '50's I was working with Darwin Quigley for the Sinclair Oil and Gas Company. At that time you and Lou Wells held the fort down on the third floor in the Newhouse Building.

If and when I am in Casper, and I hope it won't be too long before I am, I will certainly make an effort to look you up and at least say "hi".

Sincerely yours,

Duncan J. McGregor
State Geologist

DJM;jmd

SUN OIL COMPANY

MAR 9 - 1964

ROCKY MOUNTAIN DIVISION
DENVER CLUB BUILDING
P. O. BOX 1798
DENVER 1, COLORADO

WM. WALMSLEY
MANAGER

REPLY TO:
DISTRICT OFFICE
411 PETROLEUM BUILDING
P. O. BOX 1732
CASPER, WYOMING

March 5, 1964

Dr. Duncan McGregor
State Geologist
Science Center
Vermillion, South Dakota

Re: Sun Oil Co. Lance Nelson Estate # 1
Section 21, T. 7 S., R. 1 E.
Fall River County, South Dakota

Dear Sir:

Enclosed you will please find the following information on
the subject well:

- 1: Two Copies - Well History by Eldred Johnson
Consulting Geologist
- 2: Two Copies - Final Print - Sonic Gamma Ray Log
By Schlumberger
- 3: Two Copies - Final Print - Laterolog
By Schlumberger

If additional copies are needed please do not hesitate to call
on us. American Stratigraphic Company as per your requirements
has been instructed to furnish you with a cut of the samples.

Very truly yours,

SUN OIL COMPANY

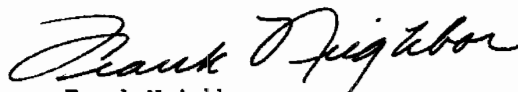

Frank Neighbor
District Exploration Manager

FN/mk
Enc.

P.S. We would appreciate your keeping the logs confidential,
since we have not released these logs to-date.

SOUTH DAKOTA

JAN 30 1964

State Water Resources Commission

STATE OFFICE BUILDING
PIERRE, SOUTH DAKOTA

January 29, 1964

**First National Bank of Black Hills
(as Trustee of the Nelson Estate)
Hot Springs, South Dakota**

Gentlemen:

I have been advised that the Sun Oil Company has obtained a Permit to Drill for Oil and Gas on your land in Section 21, T 7 S, R 1 E.

Occasionally, owners of land consider converting abandoned oil wells into water wells. Please advise me whether or not you intend to convert the oil well drill hole on your land into a water well if water is encountered and the drill hole is abandoned as an oil well.

If you are considering making a water well out of the abandoned oil well drill hole, special considerations are necessary to comply with the State's oil and water laws. The abandoned oil hole must be properly plugged and the water well properly constructed. All conversion work will be at your expense. The cost will vary, depending upon the characteristics of the drill hole, but such cost will be in the neighborhood of \$5,000 or more. Usually another driller and drill rig will have to be arranged for. This other drill rig and casing and other materials will have to be on hand to take over immediately after the special oil well plugging is completed, because the drill hole cannot be left open for any appreciable length of time without spoiling it. Approval of plans for construction of the water well will be required, and a bond covering proper construction may be required. Also, a water right may be required. All of these arrangements take considerable time to accomplish.

Please advise me immediately if you plan to convert the oil well drill hole into a water well. We both hope that a producing oil well results from the drill hole on your land; however, if not and you are planning on a water well, we must start making arrangements now.

Sincerely,

J.W. GRIMES
Chief Engineer

JWG/bw

cc State Oil and Gas Board, Secretary of State, State Capitol, Pierre, S.D.
✓ State Geologist, Dr. Duncan McGregor, Vermillion, S.D.

SURETY



**NO SURETY INFORMATION FOR
THIS WELL AS OF 5/18/2011**

MISCELLANEOUS



MAR 21 1964



INVOICE

AMERICAN STRATIGRAPHIC COMPANY

1820 BROADWAY, DENVER • 812 E. YELLOWSTONE, CASPER • 17 NO. 31st ST., BILLINGS

March 19, 1964

NC 1078

State of South Dakota Geological Survey
Attn: Dr. Duncan McGregor, State Geologist
Science Center
Vermillion, South Dakota

P. O. No.

SOUTH DAKOTA SAMPLES N/C

Cities Service #1 Carl Wagner
NW NW 13-5N-29E
Stanley Co., South Dakota

N

N/C

Cities Service #1-A Phipps
NW SW 4-2S-23E
Jackson Co., South Dakota

Sun Oil Company #1 Lance-Nelson
21-7S-1E
Fall River Co., South Dakota

PLEASE NOTE:

We are shipping these samples via
United Buckingham. Please let us
know when you receive them.

*mw
dred mcCotter*

API ID 40 047 05089

Lance #1 *Sun*
60 of 64
Edgemont Herald Tribune
February 27, 1964

Sun abandons second oil test

The Sun Oil Company plugged and abandoned their No. 1 Lance-Nelson oil test in Fall River County last Friday, Feb. 22, according to a report released this week by Earl Cox, Belle Fourche, Engineering-Petroleum Geologist of the State Geological Survey. This was the second oil test in the Edgemont area which Sun has made unsuccessfully within the past few months.

Cox said oil and gas shows were found in the Minnelusa sands by Sun in this latest test, but were not present in commercial quantities. The Company has not indicated if additional tests are planned for South Dakota, he said.

Drilling continues at the Carpenter No. 1 Cox test near the Barker Dome Field. A depth of 1530 feet had been reached by February 20, Cox reported. Information on this test is confidential and the only part being released to the public is the drilling depth.

KC 2-25-64

Fall River Oil Test Abandoned By Sun Oil Co.

BELLE FOURCHE -- Sun Oil Company plugged and abandoned its Number One Lance-Nelson oil test in Fall River County Friday, according to Earl Cox, engineering-petroleum geologist for the State Geological Survey in Belle Fourche.

Cox said the test reached a depth of 3,057 feet.

Oil and gas shows were found in the Minnelusa sands but were not present in commercial quantities.

Cox said Sun Oil Co. has not indicated if additional tests are planned in South Dakota.

Drilling continues at the Carpenter Number One Cox test near the Barker Dome field in Fall River County.

A depth of 1,530 feet had been reached Feb. 20, but Cox said information on the test is confidential and the only information being released concerns drilling depth.



Sun
62 of 64
Edgemont Herald Tribune
February 13, 1964

Sun Oil gets permit for second test well

Earl Cox, Engineering-Petroleum Geologist of the State Geological Survey, Belle Fourche last week announced that the State Oil and Gas Board granted a permit January 27 to the Sun Oil Company to drill their No. 1 Lance-Nelson Oil and gas test in Fall River County. The location is twelve miles northwest of Edgemont and will reach an estimated depth of 3200 feet. The test is seven miles east of the West Mule Creek Oil Field in Wyoming and eight miles southwest of the Barker Dome Oil Field in Custer County, South Dakota.

This test will be the second recent wildcat to be drilled by Sun Oil Company in Fall River County. Sun plugged and abandoned their No. 1 Government test a month ago after reaching a dept of 3250 feet. The No. 1 Government test was located six miles west of Edgemont.



API ID 40 047 05089

Sun
63 of 64

Rapid City Journal
January 31, 1964

Wildcat Well In Fall River Set

Sun Oil Co. was granted a permit Monday to drill an oil and gas test well in Fall River County 12 miles northwest of Edgemont, according to Earl Cox, geologist with the State Geological Survey.

The State Oil and Gas Board issued the permit for the well, the No. 1 Lance-Nelson, with drilling estimated to reach a depth of 3,200 feet.

The test is seven miles east of the West Mule Creek Oil Field in Wyoming and eight miles southwest of the Barker Dome Oil Field in Custer County.

The test will be the second recent wildcat to be drilled by Sun Oil Co. in Fall River County. The company plugged and abandoned their No. 1 government test a month ago after reaching a depth of 3,250 feet. This test was located six miles west of Edgemont.



See
64 of 64
Rapid City Journal
December 24, 1963

Sun Oil Starts Wildcat Well Near Edgemont

EDGEMONT — Sun Oil Company has set surface casing and was drilling below the 913-foot level last week at its No. 1 NCRA-Government oil well 5½ miles west of Edgemont.

The projected 3,200-foot Minnelusa wildcat is 14 miles southwest of the Barker Dome field in Fall River County, according to C. W. Sanders, owner of C. W. Sanders and Associates of Rapid City, a petroleum exploration and consulting firm.

Sanders said the information came from Rineharts Oil Report, a daily publication issued from Denver.

The wildcat was started Dec. 13 and surface casing was set at 199 feet.

In Stanley County, Cities Service Oil Co., was making hole below 2,230 feet at its No. 1 Carl Wagner well. The projected 2,500-foot wildcat is 12 miles northwest of Pierre.



Oil and Gas Search for: api_no_like '40 047 05095'		
Page 1 of 1	<u>Download Database</u> (Excel spreadsheet format)	Page: 1

Record 1 of 1

Well Information

API No:	40 047 05095	County:	FALL RIVER
Well Name:	DOLEZAL 1 DARROW	Location:	SESE 2-7S-1E
Permit No:	361	Total Depth:	2447
Operator Name:	GEORGE DOLEZAL JR	Bottom Hole:	Minnelusa
Permit Date:	07-03-1964	KB Elevation:	3797
Spud Date:	07-24-1964	Ground Elevation:	3792
Plug Date:	08-19-1964	Latitude:	43.466062
		Longitude:	-103.958032
Well Field	WILDCAT	Status	P&A
Class:	DRY HOLE	Type:	DRY HOLE

Formation Tops

<u>Formation</u>	<u>Depth (ft.)</u>
Dakota Mud	120
Lakota	300
Morrison	425
Sundance	640
Spearfish	918
Goose Egg	1240
Minnekahta	1479
Opeche	1620
Minnelusa	1616
Red Marker	2032



API No. 4004705095
2-7S-1E

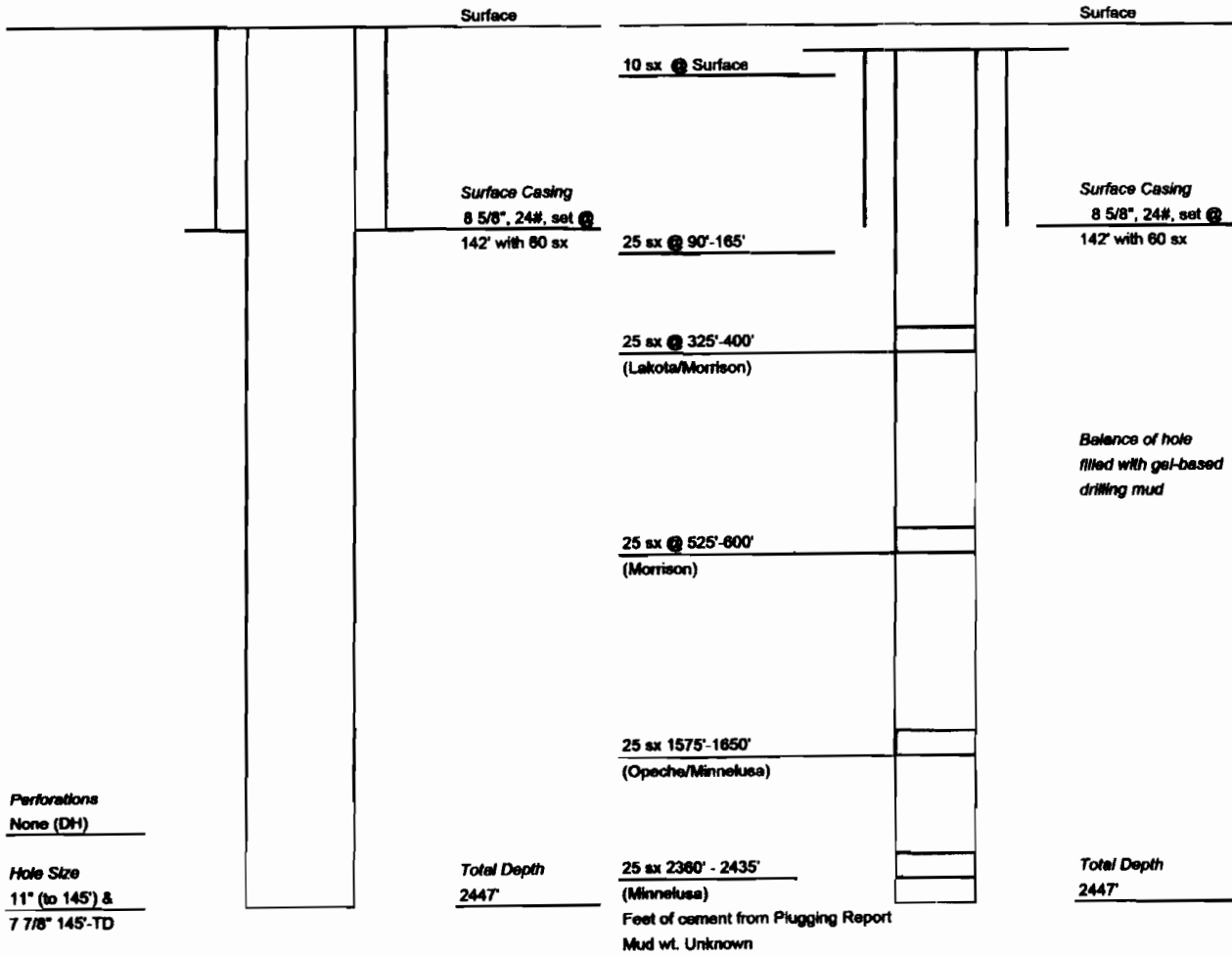



STATE OF S.D. FORM 7

PLUGGING RECORD

Operator <u>George Colozal, Jr.</u>		Address <u>1121 Tower Building, Denver, Colorado</u>		
Name of Lease <u>Paul Johnson</u>		Well No. <u>1</u>	Field & Reservoir <u>Midcat</u>	
Location of Well <u>Sec. 21, Twp. 20N, Rge. 2E, S. 11</u>		Sec-Twp-Rge or Block & Survey		County <u>Hall</u>
Application to drill this well was filed in name of <u>George Colozal, Jr.</u>	Has this well ever produced oil or gas <u>No</u>	Character of well at completion (initial production): Oil (bbls/day) _____ Gas (MCF/day) _____ Day? <u>✓</u>		
Date plugged: <u>August 19, 1965</u>	Total depth <u>2,447'</u>	Amount well producing when plugged: Oil (bbls/day) _____ Gas (MCF/day) _____ Water (bbls./day) <u>None</u>		
Name of each formation containing oil or gas. Indicate which formation opens to well-bore at time of plugging	Fluid content of each formation	Depth interval of each formation	Size, kind & depth of plugs used indicate zones squeeze cemented, giving amount cement.	

CASING RECORD

Size pipe	Put in well (ft.)	Pulled out (ft.)	Left in well (ft.)	Give depth and method of parting casing (shot, ripped etc.)	Packers and shoes
<u>2 7/8"</u>	<u>142'</u>	<u>None</u>	<u>142'</u>		

Was well filled with mud-laden fluid, according to regulations? Yes Indicate deepest formation containing fresh water.

In addition to other information required on this form, if this well was plugged back for use as a fresh water well, give all pertinent details of plugging operations to base of fresh water sand, perforated interval to fresh water sand, name and address of surface owner, and attach letter from surface owner authorizing completion of this well as a water well and agreeing to assume full liability for any subsequent plugging which might be required.

USE REVERSE SIDE FOR ADDITIONAL DETAIL

Executed this the 27th day of March 1965 in CO State of Colorado County of
 Signature of Affiant: George Colozal, Jr.

Before me, the undersigned authority, on this day personally appeared George Colozal, Jr. known to me to be the person whose name is subscribed to the above instrument, who being by me duly sworn on oath states that he is duly authorized to make the above report and that he has knowledge of the facts stated therein, and that said report is true and correct.

Subscribed and sworn to before me this 26th day of March 1965 at in County, State of Colorado
 Notary Public in and for
 My commission expires

DO NOT WRITE BELOW THIS LINE
 Approved: March 12, 1965 Date
 OIL AND GAS BOARD OF THE STATE OF SOUTH DAKOTA
Alvin Larson Secretary

Approved for release of bond
 Date March 9, 1965
 State Geologist



Cement plugs set as follows:

25 sacks	-	*	2475'	to	2050'
25 sacks	-	*	1550'	to	1575'
25 sacks	-	*	500'	to	325'
25 sacks	-	*	400'	to	325'
25 sacks	-	*	165'	to	90'

Dry hole marker and 10 sacks at surface.
Balance of hole filled with gel-base drilling mud.





SUMMARY OF WELL DATA

Operator: George Dolezal Jr., Sun Oil Co., etal.
Lease: No. 1 Earl Darrow
Location: C SE SE Section 2, T. 7S. R. 1E.
660' FSL 660' FEL
Fall River County, South Dakota.
Elevation: Ground 3792'
K. B. 3797'
Contractor: Baker Drilling Company
Rig No. 3 - Sullivan draw works
Tool Pusher: Jim Baker
Drillers: Don Garhart
Ed Buchannan
Spud Date: July 24, 1964
Completion Date: August 19, 1964
Casing: 140' 8-5/8" used 24# @ 142' ground
with 60 sacks of regular cement.
Hole Size: 11" cable tool hole to 145'
7-7/8" from 145' to total depth.
Mud: Mo-Mar Mud Company
Casper, Wyoming
J. M. Bunce Engineer
Gel base
Logging: Drilling time: From surface casing
to total depth (Geolograph)
Schlumberger: Dual Induction-Laterlog
147' to 2442'
Schlumberger: Sonic Log-Gamma Ray
147' to 2441'
Samples: 10-foot samples 140 - 2100 feet
5-foot samples 2100 - 2250 feet
10-foot samples 2250 - 2450 feet
Samples on file at AmStrat in Denver.
Geology: Well site geology by S. D. Ayres
Lost Circulation: Lost minor amounts of mud from 1630'
to total depth.



SUMMARY OF WELL DATA (continued)

Total Depth: 2450' - Driller
 2446' - Schlumberger

Status: Plugged and Abandoned

Flugs: 2435' to 2360' - 25 sacks
 1650' to 1575' - 25 sacks
 600' to 525' - 25 sacks
 400' to 325' - 25 sacks
 165' to 90' - 25 sacks
 Dry-hole marker and 10 sacks at surface.

Drill Stem Tests: Schlumberger Formation Tester
 1688' to 1690.5' Converse sand.
 Tool open 30 minutes
 Tool shut in 23 minutes
 Recovered 600 cc mud
 Pressures 0

Cores: Core #1-2155' to 2206'.
 First Leo zone (see sample desc.)

ELECTRIC LOG FORMATION TOPS

<u>Formation</u>	<u>Depth</u>	<u>Datum</u>
Fuson	300	+3497
Lakota	350	+3447
Morrison	425	+3372
Sundance	640	+3157
Spearfish	918	+2879
Goose Egg	1240	+2557
Minnekahta	1479	+2318
Opeche	1520	+2277
Minnelusa	1616	+2181
Red Shale Marker	2032	+1765

GEOLOGICAL SUMMARY

The subject well was drilled to a total depth of 2450 feet within a sand that would possibly corelate with the Third Leo sandstone of the Pennsylvanian stratigraphic section in the Lance Creek field.

The Dakota sandstone between the base of the surface casing and 300 feet gave no indications of oil staining

COUNTY: **FALL RIVER**
LEGAL LOCATION: **SESE 2-7S-1E**
API NO: **40 047 05095**
PERMIT NO: **361**
WELL NAME: **DOLEZAL #1 DARROW**
OPERATOR: **GEORGE DOLEZAL, JR.**
PERMIT ISSUED: **07/03/1964**
PERMIT CLOSED: **03/12/1965**
FILE LOCATION: **7S-1E-2 SESE**

TARGET CODES:

WELL HISTORY / CHECKLIST

PERMIT TO DRILL / INTENT TO DRILL

WELL INSPECTION / SCOUT REPORTS

OPERATOR'S TECHNICAL REPORTS / MAPS

ADMINISTRATIVE / SUNDRY REPORTS

CORRESPONDENCE

SURETY

MISCELLANEOUS



WELL HISTORY / CHECKLIST



WELL HISTORY

Well Name Dolezal #1 Darrow Permit No. 361

Location SESE 2-7S-1E - Fall River Date of Permit 7-3-64

Elev. 3792 Gr. API No. _____

Confidential X From 8-20-64 To 2-18-65

Logs Received _____

Cuttings Received _____ Cores Received _____

Drill Stem Records _____

Cap Plug and Marker Set 10-2-64

Surface Restored 10-21-64

Plugging Affidavit Signed _____ Date _____

Board Released _____ Date 3-12-65

Summary of Scout Reports

7-8-64 First visit - rig was not at location

8-3-64 Spudded 7-24-64

9-19-64 plugged

10-2-64 Marker has been placed - mud pits not filled.

10-21-64 Mud pits filled & surface smoothed.

Wireline test 1688 - 1690.5, Op 30, SI 23, Rec. 600 cc Mud, Press zero.

PERMIT TO DRILL / INTENT TO DRILL



State Pub. Co., Pierre

APPLICATION FOR PERMIT TO:

S. Dak. Oil & Gas Board
FORM 2

<input checked="" type="checkbox"/> DRILL	<input type="checkbox"/> DEEPEN	<input type="checkbox"/> PLUG BACK	FARM OR LEASE NAME
<input checked="" type="checkbox"/> OIL WELL	<input type="checkbox"/> GAS WELL	<input type="checkbox"/> SINGLE ZONE	Carl Jarow
			WELL NO.
			No. 1
OPERATOR			FIELD AND POOL OR WILDCAT
George Dolezal, Jr.			Wildcat
ADDRESS			NO. ACRES IN LEASE
1111 Tower Building, Denver 2, Colorado			400
LOCATION (In feet from nearest lines of section or legal subdivision, where possible)			1/4 Sec. 2, Twp. 2 N., R. 10 E., S. 1 Range 1 East
937.5 feet north - 450 feet from the southeast corner of Section 2, Township 2 South, Range 1 East			COUNTY
			Fall River
NAME AND ADDRESS OF SURFACE OWNER		ELEVATION	NO. OF WELLS ETC.
Carl Jarow, Dewey, South Dakota		3792	2
NAME AND ADDRESS OF CONTRACTOR		PROPOSED DEPTH	ROTARY OR CABLE TOOLS
Laker Drilling Company, Casper, Wyoming		2450 ft.	Rotary
			APPROXIMATE DATE WORK WILL START
			July 10, 1964

IF LEASE PURCHASED WITH ANY WELLS DRILLED, FROM WHOM PURCHASED (Name and address)

PROPOSED CASING AND CEMENTING PROGRAM					
SIZE OF HOLE	SIZE OF CASING	WEIGHT PER FOOT	NEW OR SECOND HAND	DEPTH	SACKS OF CEMENT
12 inch	3-5/8 inch	24 lbs.	new	150 feet	100

DESCRIBE PROPOSED OPERATIONS. IF PROPOSAL IS TO DEEPEN OR PLUG BACK, GIVE DATA ON PRESENT PRODUCTIVE ZONE AND PROPOSED NEW PRODUCTIVE ZONE. GIVE BLOW OUT PREVENTER PROGRAM IF ANY

Principal objective is the Leo Sands of the Minnelusa formation. Proposed to drill to 2450 feet, or to a point 400 feet below the top of the 400 marker and test any zones having significant shows of oil or gas

SIGNED George Dolezal, Jr. TITLE Operator DATE July 1, 1964

PERMIT NO 301 DO NOT WRITE BELOW THIS LINE

CHECKED BY Edward Linn 7/3/64
School and Public Lands Secretary

APPROVAL DATE July 3, 1964

CONDITIONS:
 COMPLETE SET OF SAMPLES, AND CORES IF TAKEN, MUST BE SUBMITTED.
 SAMPLES, AND CORES IF TAKEN, BELOW DEPTH, MUST BE SUBMITTED.

*See Instructions On Reverse Side

882 100



TRIANGLE COMPANY

N. W. Corner

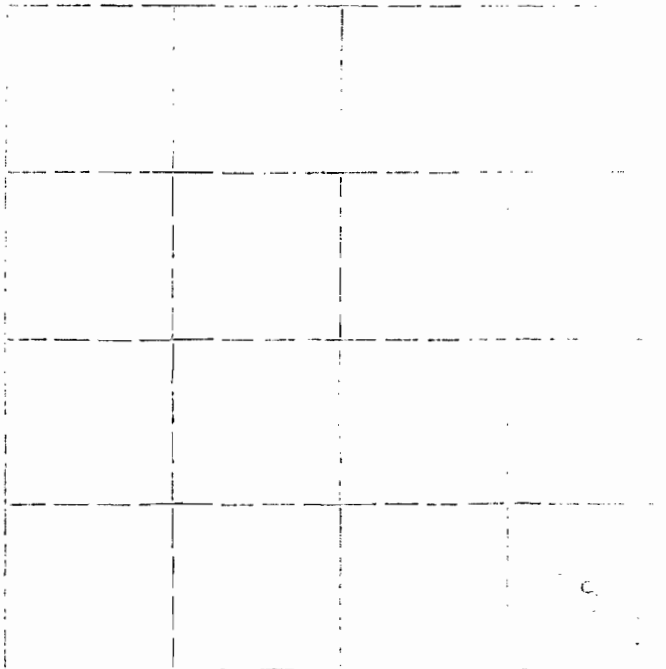

S. W. Corner

S. E. Corner

I, Joseph Dodd of the County of Jefferson State of Colorado that in accordance with a request from Triangle Company, Inc. of Denver, Colo. for the purpose of

I made a survey (date) 9/27/10 for the location and elevation of the center of the corner of Section 2, T7S, R1E, S10W, Jefferson County, Colorado

As shown on above map, the location is in Section 2, Township 7S, Range 1E, South of 10th North Meridian, Jefferson County, Colorado

WELL INSPECTION / SCOUT REPORTS

SCOUT REPORT

Well Name: Dolezal #1 Darrow Location: 7S-1E-2 SESE, Fall River Directions: 933.5 FNL and 450 west of SE corner Spud Date: 7-24-64 Elevation: 3792	Permit Date: 7-3-64 Permit #: 361 API: 40 047 05095 Plug Date: 8-19-64 Total Depth: 2446
---	---

DATE					
Dry Hole Mark					
Marker Correct					
Marker Sturdy					
Marker Capped					
Fences Up					
Pits Back Fill					
Site Levelled					
Site Smoothed					
Site Seeded					
Site Clean					
Roads Reclaim					
Approved by					
Not Approved					

Remarks:

7- 8-64: Mud pits has not been dug. Rig was not at location
 8- 3-64: Casing 8 5/8 142 feet. By phone from Dolezal - drilling at 977 in Spearfish.
 Spudded July 24, 1964, set 142' 8 5/8 surface casing with 60 sacks, drilled 0-977'. Geologist Sam Ayres.
 8- 6-64: Drilling at 1700 in Minnelusa, drilled from 977-1700. Saple tops:
 Lakota 320, Morrison 407, Sunsance 600, Spearfish 932,
 Minnekahta 1472, Opeche 1508
 8-13-64: Coring at 2163, drilled from 17-0-02155, Cored from 2155-2163
 8-18-64: Drilling at 2429 and preparing to log, drilled from 2162-2429
 8-19-64: Plugged 2435-2360 25 sacks Leo Sand
 1650-1575 25 sacks Top Minnelusa
 600- 525 25 sacks top Sundance
 400- 325 25 sacks top Lakota
 165- 90 25 sacks base surface casing
 10 sacks surface plug



cored 2155-2206 no shows, DST #1 1688-90 12(?) recovered only a little drilling mud-formation tight, drilled 2206-2446, run induction-laterolog and gamma ray sonic. Tentative log tops:

Fuson-300, Lakota-350, Morrison-460, Sundance-640, Basal Sundance sand-866, Triassic-918, Minnekahta-1479, Opeche-1520, Minnelusa-1578, Red Marker-2032, 3rd Leo-2400

9-21-64: Abandonment marker had been placed, mud pits filled and surface smoothed satisfactorily.

signed by Earl Coy

STATE GEOLOGICAL SURVEY

Scout Report

Date scouted . September 21, 1964

Owner Dolezal

Designation of well . . . #1 Darrow

Location: Sec. 2 T. 7 N. S. R. 1 E. N.

. . Fall River County, S. Dak.

Total Depth 2446 feet

Casing Record:

8 5/8 142 Ft. Ft.

 Ft. Ft.

work in progress at time of visit:

None

Developments since last visit:

Mud pits had been filled and surface smoothed satisfactorily

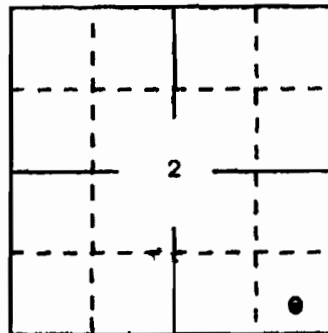

Remarks and recommendations:

Scouted by Earl Cox, Geologist

Approved by Duncan J. Mosegoe
Duncan J. Mosegoe, State Geologist



STATE GEOLOGICAL SURVEY

Scout Report

Confidential

Date scouted . Sept. 2, 1964 . . .

Owner Dolezal

Designation of well . #1 Darrow

Location: Sec. 2 T. 7 N. S. R. 1 E. 1/4

. . . Fall River County, S. Dak. Total Depth . 2446 . . feet

Casing Record:

8 5/8 142 Ft. Ft.

 Ft. Ft.

work in progress at time of visit:

None

Developments since last visit:

Abandonment marker had been placed.

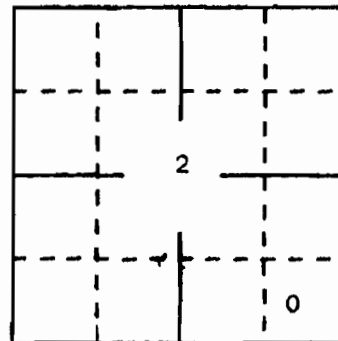

Remarks and recommendations:

Mud pits not filled.

Scouted by Earl Cox, Geologist

Approved by *Duncan J. McGregor*

Duncan J. McGregor, State Geologist

Confidential

Permit No. 361

STATE GEOLOGICAL SURVEY

Scout Report

Date scouted August 19, 1964.

Owner. Dolezal

Designation of well. . #1 Darrow

Location: Sec. 2 T. 7 N. S. R. 1 E. W.

. . . . Fall River, County, S. D. Total Depth . . 2446. . . . feet

Casing Record:

8 5/8 142 Ft. Ft.

Ft. Ft.

Plugged as follows:

Work in progress at time of visit:

- 2435-2360 25 sacks Leo Sand
- 1650-1575 25 sacks Top Minnelusa
- 600-525 25 sacks Top Sundance
- 400-325 25 sacks Top Lakota
- 165-90 25 sacks Base surface casing
- 10 sacks Surface plug

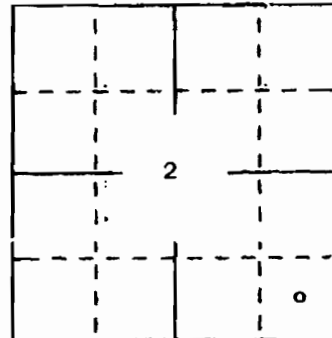

Developments since last visit:

- Cored 2155-2206 No shows
- Dst#1 1688-90(?) Recovered only a little drilling mud - formation tight
- Drilled 2206-2446
- Run induction-Laterolog and gamma ray sonic

Remarks and recommendations:

Tentative log tops:

- Fuson - 300
- Lakota - 350
- Morrison - 460
- Sundance - 640
- Basal Sundance Sand - 866
- Triassic - 918
- Minnekahta - 1479
- Opeche - 1520
- Minnelusa - 1578
- Red Marker - 2032
- 3rd Leo - 2400

Scouted by. Earl Cox, Geologist

Approved by Duncan J. McGregor State Geologist

STATE GEOLOGICAL SURVEY

Scout Report

Date scouted . August 18, 1964

Owner Dolezal

Designation of well . . #1 Darrow

Location: Sec. 2 T. 7 M. S. R. 1 E. W.

. . . Fall River County, S. Dak. Total Depth . 2429 . feet

Casing Records:

8 5/8 142 Ft. Ft.
 Ft. Ft.

Work in progress at time of visit:

Drilling at 2429 and preparing to log

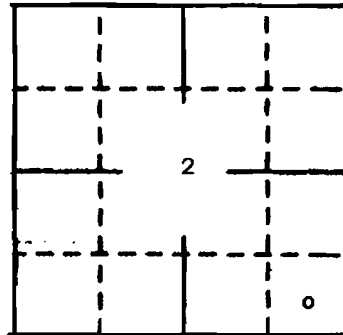

Developments since last visit:

Drilled from 2163-2429 (details later)

Remarks and recommendations:

Scouted by Earl Cox, Geologist
Approved by *Duncan J. McGror*
Duncan J. McGror, State Geologist

STATE GEOLOGICAL SURVEY

Scout Report

Date scouted August 13, 1964

Owner Dolezal

Designation of well . . . #1 Darrow

Location: Sec. 2 T. 7 N. S. R. 1 E. W.

. . . Fall River County, S. Dak. Total Depth 2163 . . feet

Casing Record:

8 5/8 142 Ft. Ft.
 Ft. Ft.

Work in progress at time of visit:

Coring at 2163

Developments since last visit:

Drilled from 1700-2155
Cored from 2155-2163

Remarks and recommendations:

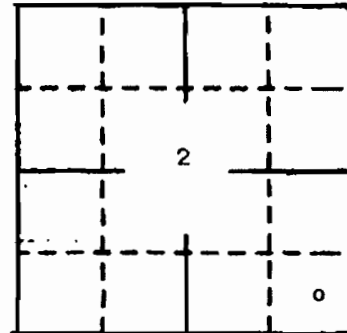

Scouted by Earl Cox, Geologist

Approved by Duncan J. McGregor
Duncan J. McGregor, State Geologist



STATE GEOLOGICAL SURVEY

Scout Report

Date scouted August 6, 1964.

Owner Dolezal

Designation of well . . #1 Darrow

Location: Sec. 2 T. 7 N. S. R. 1 E. W.

. Fall River, County, S. Dak. Total Depth 1700 feet

Casing Records:

8 5/8 142 Ft. Ft.

 Ft. Ft.

Work in progress at time of visit:

Drilling at 1700 in Minnelusa

Developments since last visit:

Drilled from 977-1700

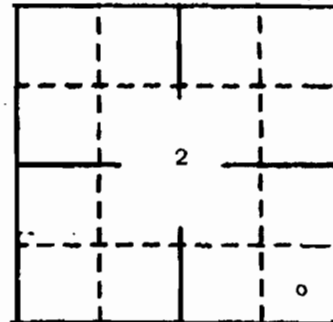

Remarks and recommendations:

Sample tops: Lakota 320
Morrison 407
Sundance 600
Spearfish 932

Minnekahta 1472
Opache 1508

Scouted by Earl Cox, Geologist

Approved by *Duncan J. McGregor*
Duncan J. McGregor, State Geologist



STATE GEOLOGICAL SURVEY

Scout Report

Date scouted August 3, 1964.

Owner Dolezal

Designation of well . . #1 Darrow

Location: Sec. 2 T. 7 N. S. R. 1 E. W.

. . Fall River County, S. Dak. Total Depth 977 feet

Casing Record:

8 5/8 142 Ft. Ft.
 Ft. Ft.

Work in progress at time of visit:

By phone from Dolezal

Drilling at 977 in Spearfish

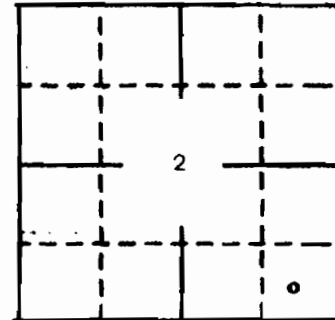

Developments since last visit:

Spudded July 24, 1964
Set 142' 8 5/8" surface casing with 60 sacks.
Drilled 0-977'

Remarks and recommendations:

Geologist: Sam Ayres, Rainbow Motel, Edgemont, South Dakota

Scouted by Earl Cox, Geologist

Approved by *Duncan J. McGregor*
Duncan J. McGregor, State Geologist

STATE GEOLOGICAL SURVEY

Scout Report

Date scouted . July 8, 1964 .

Owner . . . Dolezal

Designation of well . #1 Darrow

Location: Sec. 2 T. 7 N. S. R. 1 E. W.

. County, S. Dak. Total Depth . . . ⁰ . feet

Casing Records:

_____ Ft. _____ Ft.
_____ Ft. _____ Ft.

Work in progress at time of visit:

Mud pits had not been dug
Rig was not at location

Developments since last visit:

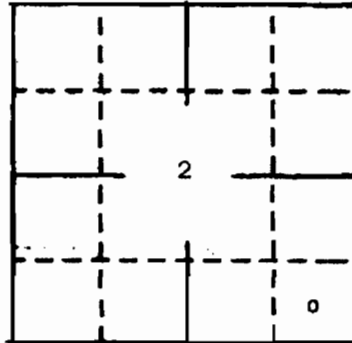

Remarks and recommendations:

Scouted by . . . Earl Cox, Geologist

Approved by *Duncan J. McGregor*
Duncan J. McGregor, State Geologist



API ID 40 047 00005

Aug 18, 4 -
7:30 P.M.
T.D. 2446

25 M 2435 - 2360 base.

25 M 1575 - 1650 T.ML

25 M 555 - 600 T. Sec.

25 M 325 - 400 Lab.

~~25 M 1000 - 1050~~

25 165 - up Surface.

Torp

135 M,

Loggs. Qual induction - Saturday

7 3/8 hole

Cored 2155 - 2206
no shows.

Room 11 - Sam Hayes

Chuck Reiling - Superior

Hypp Hill - 662-7312

Dst #1
1688-902

~~25 M 1000 - 1050~~
No Recovery at all
way hits.

Aug 19, 1964
Dst #1 Run
to test plugged.

Confidential

Log logs - tentative. 24 of 63

300	Fusion
350	Lab
460	Max.
640	Jan
870 860	Base/ Surface 50.
718	T.ML
1479	mL
1580	SP
1578	Mil
2032	Red marker
2400	3rd Leo
	2nd Leo

T.D. 2446

~~Letter from Dolygal. Wants~~
to ~~cancel~~ ~~keep~~ ~~log~~
Sept 2, 1964

marker in O.K.
pits not filled

Sept. 2, 1964
Letter from Dolygal. Wants
to continue keeping logs
& Schlumberger logs Confidential.

Sept. 21, 1964
pits filled & surface
levelled. Ratio following



Dolezal #1 Darrow
C SESE-2-75-1E
Fall River County

Geo. Dolezal Jr.
1121 Tower Blt. Denver 2

Surface
Earl Darrow-Dewey, S.D.

Contractor
Baker Drilling Co.

Elw: 94 3792
RB 3797

Permit: July 3 64 No. 261
T.P. 2450 (Geo on 400 below
Kalmankon)

Plan to Start July 10.

Aug 6, 1964

© 1700' in ml.

Sample tops:
Loh 320
Mon 407
Sun 600
Sp 932
mk 1472
op 1508

Est T.D. Aug 13

Aug 13

Coring at 21 55-63
no Dst or other Corrs

Corran.
Wm. Sillig no slow the
thought that Coring was
fought. Coring at 30 min
off.

July 8, 1964
No pit on Rig. Could
be located.

July 13, 64
Could find nothing
neither pit on Rig.

July 30, 1964
Called Dodge. He said
Baker had his rig line down
A that Holwell had spudded
July 24 and was going to
set surface for Baker.

Aug 3, 1964
Phone call from Dolezal
spudded July 24
Set 85% 142' G.L. 6004
morning; Aug 3 at 977 in Spud pit
Ced: 10 Sam Ayres - Rainbow

Plan from Ayres.

© 2429 and will
Build about 10 more
feet and log.
Gamma Ray, Sonar
w/ Caliper + dual
induction laterolog.

~~Log~~ Log plan
20' logs - 25' 24
ml - 25'
logs - 25'
Loh - 25'
box surface - 25'
logs surface + Mohr
Should log by surface
- the log.



26 of 63

APR 10 40 047 05095

WESLEY 2 T-75 RIE
Fall River Co
alt - 3792
Geology - Sam Aguirre

July 8, 1964

Hand-pete not doing, sig not at location

8-6-64

Drilling at 427 - open hole
at 1420 8 2/3 sig

8-6-64

Drilling at 1700 in Mammalian
stage

Fakota 320
Mammalian 407
Ludlow 600
Opole 1500

8-13-64

Corning at 2163

8-18-64

Drilling at 2424

Well plugged
 Corrod 2155 - 2200 (in hole)
 DST # 1 1688 - 90' in hole
 Non induction - fetterly + 2R
 T/D 244

Log:
 from 300 418
 Level - 55.0 Membrane 1479
 Pressure - 400 Specific 15.20
 Density 640 Membrane 11.78
 base sand - 960 Red number - 2032
 3rd leg - 2400

9-2-64
 Abandonment marks placed; mud
 pits not filled.

9-21-64
 Mud pits filled + surface
 restored.



WELL; - *10-047-05095*

LOCATION; -

LOGS RECD; -
TOPS; -

GEOLOGIC; - *copy with completion logs*

ELECTRIC, FIELD; -
FINAL; - *2 End LL*

RADIO, FIELD; -
FINAL; - *2 some GR*

OTHERS; - *2 film test*

CUTTINGS RECD; - *2-9-65*

CORES RECD; - *2-9-65*

DRILL STEM DATA RECD; -

CAP PLUG CHECKED; - *OK*
Mud pits filled

PLUGGING AFFIDAVIT SIGNED; - *3-10-65*
copy of 505 from 4-1-65 *the other 2 copies*
1 copy of form 446 + 3 copies from 4-1-65 *3-10-65*

OPERATOR'S TECHNICAL REPORTS / MAPS



George Dolezal Jr., Sun Oil Co., et al
No. 1 Earl Darrow
Fall River County
South Dakota

Contents

	Page
Summary of Well Data	1
Electric Log Formation Tops	2
Geological Summary	2
Sample Description	4
Chronological History	9
Bit Record	10
Deviation Surveys	10
Drilling Time	11
Coring Time	12



SUMMARY OF WELL DATA

Operator: George Dolezal Jr., Sun Oil Co., etal.

Lease: No. 1 Earl Darrow

Location: C SE SE Section 2, T. 7S. R. 1E.
660' FSL 660' FEL
Fall River County, South Dakota.

Elevation: Ground 3792'
K. B. 3797'

Contractor: Baker Drilling Company
Rig No. 3 - Sullivan draw works
Tool Pusher: Jim Baker
Drillers: Don Garhart
Ed Buchannan

Spud Date: July 24, 1964

Completion Date: August 19, 1964

Casing: 140' 8-5/8" used 24# @ 142' ground
with 60 sacks of regular cement.

Hole Size: 11" cable tool hole to 145'
7-7/8" from 145' to total depth.

Mud: Mo-Mar Mud Company
Casper, Wyoming
J. M. Bunce Engineer
Gel base

Logging: Drilling time: From surface casing
to total depth (Geolograph)

Schlumberger: Dual Induction-Laterlog
147' to 2442'

Schlumberger: Sonic Log-Gamma Ray
147' to 2441'

Samples: 10-foot samples 140 - 2100 feet
5-foot samples 2100 - 2250 feet
10-foot samples 2250 - 2450 feet

Samples on file at AmStrat in Denver.

Geology: Well site geology by S. D. Ayres

Lost Circulation: Lost minor amounts of mud from 1630'
to total depth.



SUMMARY OF WELL DATA (continued)

Total Depth: 2450' - Driller
2446' - Schlumberger

Status: Plugged and Abandoned

Plugs: 2435' to 2360' - 25 sacks
1650' to 1575' - 25 sacks
600' to 525' - 25 sacks
400' to 325' - 25 sacks
165' to 90' - 25 sacks
Dry-hole marker and 10 sacks at surface.

Drill Stem Tests: Schlumberger Formation Tester
1688' to 1690.5' Converse sand.
Tool open 30 minutes
Tool shut in 23 minutes
Recovered 600 cc mud
Pressures 0

Cores: Core #1-2155' to 2206'.
First Leo zone (see sample desc.)

ELECTRIC LOG FORMATION TOPS

<u>Formation</u>	<u>Depth</u>	<u>Datum</u>
Fuson	300	+3497
Lakota	350	+3447
Morrison	425	+3372
Sundance	640	+3157
Spearfish	918	+2879
Goose Egg	1240	+2557
Minnekahta	1479	+2318
Opeche	1520	+2277
Minnelusa	1616	+2181
Red Shale Marker	2032	+1765

GEOLOGICAL SUMMARY

The subject well was drilled to a total depth of 2450 feet within a sand that would possibly correlate with the Third Leo sandstone of the Pennsylvanian stratigraphic section in the Lance Creek field.

The Dakota sandstone between the base of the surface casing and 300 feet gave no indications of oil staining



GEOLOGICAL SUMMARY (continued)

or fluorescence.

No indications of oil and/or gas were noted in the Lakota horizon.

The Canyon Spring sandstone of the Sundance was missing.

A circulated sample of the First Converse sandstone at 1638 feet showed no oil staining. A circulated sample of a Converse sand at an electric log depth of 1690' showed no indication of oil or gas staining.

Minor amounts of lost circulation occurred from 1650' to total depth but this did not noticeably effect the drilling or the samples.

The First Leo sandstone was cored, no effective or reservoir sands were found and no staining was noted.

No effective sands or staining was found in the Second Leo zone.

The Third Leo zone did contain some possible reservoir sands but no staining or fluorescence was noted .

Because of electric log interpretation a Schlumberger formation test was made on the Converse sand from 1688 feet to 1690.5 feet.

No shows of oil and/or gas and the lack of reservoir beds in the Leo zones led to the decision to abandon this well without further testing.

E. D. Ayres



SAMPLE DESCRIPTION

Surface - Skull Creek
10-foot samples between 140 and 2100 feet.
Samples have been corrected for lag.

140 - 180 Sand, fine grained, sub-rounded, vitreous, friable, white, well sorted, good permeability and porosity. Some gray friable siltstone. No show.

180 - 200 Siltstone, medium gray, friable.

200 - 230 Shale, light to pale gray, silky, waxy, bentonitic.

230 - 250 Sand, fine to coarse grained, conglomeritic, poorly sorted in part, with white to pale green matrix, rounded to angular. No shows.

250 - 260 Shale, medium to dark gray.

260 - 300 Sand, fine grained, friable, clay-filled, white to pale green, slightly glauconitic. No shows. Traces of dark gray to red to rose to yellow silty shale.

300 TOP FUSON SHALE

300 - 330 Shale, silty, slightly conglomeritic, yellow.

330 - 350 Shale, as above, traces of sand, fine to medium grained, calcareous. Traces of good porosity. No show.

350 TOP LAKOTA

350 - 380 Sand, fine to medium grained, vitreous to frosted, slightly calcareous, pink to red. No show. Some traces of shale.

380 - 425 Sand, fine to very coarse grained, vitreous to coated, friable, clay-filled, mostly red, poorly sorted, sub-rounded, numerous free floating sand grains, conglomeritic. No shows.

425 TOP MORRISON

425 - 450 Shale, gray to green to yellow. Quit waxy, traces of gray bentonite.

450 - 460 Sand, fine grained, angular, frosted, hard, poorly sorted, tight. No show.

460 - 490 Shale, dark gray to dark green, waxy, soft.

490 - 520 Shale, green, waxy, bentonitic. Trace of pyrite. Traces of calcite crystals and white crystalline limestone.

520 - 550 Shale, green, as above. Red to maroon silty shale.

550 - 550



SAMPLE DESCRIPTION (continued)

- 550 - 620 Shale, light gray to green, traces of buff to gray dense limestone. Traces of white sandy limestone.
- 620 - 640 Shale, medium to dark gray.
- 640 TOP SUNDANCE
- 640 - 700 Shale, light gray to green, silty. Traces of green glauconitic, fine grained, friable sandstone. No show.
- 700 - 750 Sand and shale, as above. Trace + of sand, fine grained, white, friable, slightly calcareous. No show.
- 750 - 870 Sand, fine to medium grained, vitreous to coated, friable, white to gray to pink to red, slightly calcareous, traces of good porosity. No show. Shale, gray to green to red to purple. Silty in part.
- 870 - 920 Shale, silty, red, gray to green. Traces of sand, as above.
- 918 TOP SPEARFISH
- 920 - 1000 Red silty shale.
- 1000 - 1110 Red silty shale, traces of red silty sand. No show.
- 1110 - 1240 As above. Traces of white anhydrite, buff to white limestone and calcite.
- 1240 TOP GOOSE EGG
- 1240 - 1250 Anhydrite, white.
- 1250 - 1280 Shale, red, very silty to sandy, very hard and brittle.
- 1280 - 1480 Anhydrite, white, sucrosic, interbedded with red silty shale. Traces of dolomite.
- 1480 TOP MINNEKAHTA
- 1480 - 1520 Dolomite - limestone, gray to buff to white to pink to purple. Micro-crystalline to dense, some sucrosic. No show. Good mineral fluorescence, no cut.
- 1520 TOP OFEGHE
- 1520 - 1560 Shale, red to purple, silty to a sandy shale to a silty sand, fine grained, friable, coated. No show.



SAMPLE DESCRIPTION (continued)

- 1560 - 1590 Red silty shale, as above and white sucrosic anhydrite, slightly dolomitic.
- 1590 - 1620 Red silty to sandy shale to a red, hard, brittle, very fine grained silty sand.
- 1616 TOP MINNELUSA
- 1620 - 1660 Sand, medium grained, rounded to sub-rounded, vitreous to frosted, friable, white to pink to red, good porosity in part, clay-filled in part, fairly well sorted. Red sand is dolomitic. Sand becomes more red at the base. No show.
- 1660 - 1680 Anhydrite, gray, hard, dense.
- 1680 - 1690 Sand, medium grained, rounded to sub-rounded, vitreous to frosted, friable, slightly dolomitic. red. Traces of good porosity. No show.
- 1690 - 1750 Anhydrite, gray, hard, dense. Traces of red and gray silty shale. Traces of dolomite and sand.
- 1750 - 1775 Shale, red to gray, silty. Traces of sand. Traces of medium grained, well sorted, friable, clay-filled red to pink sand. No show.
- 1775 - 1830 Dolomite, buff to gray, fairly hard, sucrosic.
- 1830 - 1855 Dolomite - anhydrite, buff to gray, micro-crystalline, very hard.
- 1855 - 1865 Sand, medium to coarse grained, rounded to sub-rounded, vitreous to frosted, friable, poorly sorted, white, clay-filled, dolomitic, poor porosity. No show.
- 1865 - 1880 Dolomite, buff to gray, traces of pink.
- 1880 - 1905 Dolomite, buff to white, dense. Traces of sand and anhydrite.
- 1905 - 1915 Sand, medium grained, dolomitic and anhydritic. No show.
- 1915 - 1940 Anhydrite, white to buff to pink. Some gray.
- 1940 - 1960 Dolomite, buff to pink to red, mostly pink, hard, dense. 20% buff to red very dolomitic sand, very hard,
- 1960 - 2000 Dolomite, as above with increase in fairly friable sand as above. No show.
- 2000 - 2020 Anhydrite, white to buff to gray.
- 2020 - 2030 Dolomite, buff to gray to pink.

SAMPLE DESCRIPTION (continued)

2030	<u>TOP RED SHALE MARKER</u>
2030 - 2042	Shale, red to pink to yellow, fissile, metallic luster.
2042 - 2070	Dolomite, white to buff to gray to pink, hard and dense.
2070 - 2085	Dolomite, gray, very hard, micro-crystalline. Shale, very black, hard, brittle.
2085 - 2125	Dolomite, dark gray to black, some brown and tan, micro-crystalline. Chert, vitreous, angular, some smoky. Dark gray to black dolomitic shale with oily taste. No cut or fluorescence.

Five foot samples from 2100 to 2250 feet.

2125 - 2145	Dolomite, as above, with no chert. Traces of a poorly sorted dolomitic sand. No show.
2145 - 2151	Dolomite, medium to dark gray, micro-crystalline, hard, slightly anhydritic.

Core #1 2155 to 2206 feet is adjusted up four feet in depth to fit the electric log.

2151 - 2152.5	Sand, gray, fine grained, well sorted, anhydrite filled, hard, tight, no porosity. No show.
2152.5 - 2153	Sand, gray, fine grained, well sorted, trace of porosity, slightly dolomitic, No show.
2153 - 2158	Dolomite, gray, hard, dense, micro-crystalline. Slightly shaley.
2158 - 2160.5	Shale, black, carbonaceous, micaceous, hard.
2160.5 - 2167	Sand, gray to greenish gray, fine grained, anhydrite and dolomite filled, well sorted, hard, tight, no porosity. No show.
2167 - 2171	Anhydrite, gray, hard.
2171 - 2176	Shale, black, micaceous, carbonaceous, with occasional anhydrite streaks.
2176 - 2180	Shale, black, carbonaceous, micaceous, with sulfur odor.
2180 - 2188.5	Sand, gray to greenish gray, fine grained, anhydrite and dolomite filled, well sorted, hard, tight, no porosity. No show.
2188.5-2189.5	Shale, gray, hard.



SAMPLE DESCRIPTION (continued)

- 2189.5 - 2194 Sand, gray to greenish gray, fine grained, anhydrite and dolomite filled, well sorted, hard, tight, no show.
- 2194 - 2202 Dolomite, gray to brown, anhydritic, trace of vuggy porosity.

End of core #1

- 2202 - 2206 Shale, black, carbonaceous, micaceous.
- 2203 - 2218 Dolomite, gray, dense.
- 2218 - 2220 Shale, black, micaceous, carbonaceous.
- 2220 - 2228 Dolomite, gray, dense.
- 2228 - 2230 Shale, black, carbonaceous, micaceous.
- 2230 - 2238 Dolomite, gray, dense.
- 2238 - 2242 Shale, black, carbonaceous, micaceous.
- 2242 - 2250 Sand, fine to medium grained, rounded, vitreous to frosted, hard to friable, anhydrite filled and dolomite filled, tight. No show.

Ten foot samples from 2250 to 2450 feet. Total depth.

- 2250 - 2268 Dolomite, gray, hard.
- 2268 - 2272 Black silty shale with oily taste.
- 2272 - 2298 Dolomite, gray, hard, traces of sand and anhydrite as above.
- 2298 - 2300 Black silty shale.
- 2300 - 2325 Dolomite, gray to dark gray, hard, dense, traces of sand as above.
- 2325 - 2395 Sand, fine grained, rounded, frosted, very calcareous, lime or dolomite matrix. Very dense, tight, buff to tan. No show. Traces of medium grained, rounded, frosted, friable, slightly clay-filled sandstone. Trace of porosity, white. No show.
- 2395 - 2400 Dolomite, gray, dense.
- 2400 - 2450 Sand, fine to medium grained, mostly fine, rounded, frosted, calcareous, friable. Trace to fair porosity, white to buff to gray. No show.
- 2450 Total Depth.



Chronological History

7-24-64- C4 Spudded 11" cable tool surface hole.
7-27-64 Set 140 feet of 8-5/8" used 24# pipe with 60 sacks of regular cement at 142 feet ground. Plug down 10:00 P.M.

7-28-64 Waiting on rotary
7-29-64 Waiting on rotary
7-30-64 Waiting on rotary
7-31-64 Moving in rotary and rigging up.
8- 1-64 Finished rigging up. Drilled out from under surface @ 6:30 P.M. Drilled to 415 feet.

8- 2-64 Drilled to 530 feet, made trip for bit #2.
Drilled to 572 feet, made trip for bit #3.
Drilled to 925 feet

8- 3-64 Drilled to 977 feet, made trip for bit #4.
Strapped out of hole and found a 33 foot error. 977 feet equals 1010 feet. Drilled to 1217 feet, started trip for bit #5.

8--4-64 Finished trip for bit #5. Drilled to 1341 feet. Made trip for bit #6. Drilled to 1410 feet.

8- 5-64 Drilled to 1525 feet. Made trip for bit #7.
Drilled to 1590 feet.

8- 6-64 Drilled to 1622 feet. Made trip for bit #8.
Drilled to 1752 feet.

8- 7-64 Drilled to 1756 feet. Made trip for bit #9.
Began mudding up. Drilled to 1834. Made trip for bit #10. Drilled to 1845 feet.

8- 8-64 Drilled to 1875 feet. Made trip for bit #11.
Drilled to 1933 feet.

8- 9-64 Drilled to 1942 feet. Made trip for bit #12.
Drilled to 1987 feet. Started trip for bit #13.

8-10-64 Finished trip for bit #13. Drilled to 2036 feet. Made trip for bit #14. Drilled to 2075 feet.

8-11-64 Drilled to 2091 feet. Made trip for bit #15. Drilled to 2116 feet.

8-12-64 Drilled to 2125 feet. Made trip for bit #16. Drilled to 2155 feet. Came out of hole to go in with core barrel for core #1.

8-13-64 Cored from 2155 feet to 2200 feet.
8-14-64 Cored from 2200 feet to 2206 feet. Reamed core hole. Drilled to 2250 feet. Twisted off.

8-15-64 Recovered fish. Drilled to 2275 feet with bit #19.

8-16-64 Drilled to 2285 feet. Made trip for bit #20.
Drilled to 2309 feet. Made trip for bit #21.
Drilled to 2318 feet.



CHRONOLOGICAL HISTORY (continued)

8-17-64 Drilled to 2341 feet. Made trip for bit #22.
 Drilled to 2400 feet.
 8-18-64 Drilled to 2429 feet. Made trip for bit #23.
 Drilled to 2450 feet. Ran logs.
 8-19-64 Ran Schlumberger Formation Test #1. P. & A.

BIT RECORD

No.	Size	Make	From	To	Footage	Hours
1	7-7/8	Retip	140	530	390	8.50
2	7-7/8	Retip	530	605	75	2.00
3	7-7/8	Retip	605	1010	405	11.25
4	7-7/8	Retip	1010	1217	207	12.50
5	7-7/8	Retip	1217	1341	124	11.50
6	7-7/8	Retip	1341	1525	184	22.00
7	7-7/8	Retip	1525	1622	97	7.50
8	7-7/8	Retip	1622	1756	134	14.00
9	7-7/8	Retip	1756	1834	78	14.00
10	7-7/8	Retip	1834	1875	41	11.50
11	7-7/8	Retip	1875	1942	67	11.50
12	7-7/8	Retip	1942	1987	45	11.50
13	7-7/8	Retip	1987	2036	49	14.50
14	7-7/8	Retip	2036	2091	55	16.00
15	7-7/8	Retip	2091	2125	34	14.00
16	7-7/8	Retip	2125	2155	30	11.50
17	7-27/32	Christ. Diam.	2155	2206	51	24.00
18	7-7/8	Retip	2206	2250	46	14.00
19	7-7/8	Retip	2250	2285	35	12.50
20	7-7/8	Retip	2285	2309	24	8.25
21	7-7/8	Retip	2309	2341	32	10.50
22	7-7/8	Retip	2341	2429	88	17.00
23	7-7/8	Retip	2429	2450	21	2.75

DEVIATION SURVEYS

<u>Depth</u>	<u>Degrees</u>	<u>Depth</u>	<u>Degrees</u>
977	1	1834	1/2
1217	3/4	1942	3/4
1525	3/4	2125	3/4
		2341	3/4



DRILLING TIME - FIVE-FOOT INTERVALS

150 - 200	5	4	4	4	8	8	9	6	6	6
200 - 250	7	4	3	2	5	5	4	4	3	3
250 - 300	2	3	4	4	3	3	6	7	5	3
300 - 350	3	3	3	4	4	4	5	3	3	3
350 - 400	2	1	2	1	3	3	3	2	2	2
400 - 450	3	17	9	6	10	8	7	8	20	19
450 - 500	8	9	11	6	7	6	8	6	8	7
500 - 550	8	8	8	8	11	10	9	12	15	10
550 - 600	8	10	17	11	13	14	17	17	15	8
600 - 650	8	9	5	7	6	5	6	6	6	9
650 - 700	6	5	6	7	9	8	6	6	5	5
700 - 750	4	5	5	4	7	9	8	4	7	5
750 - 800	5	4	7	5	5	5	5	6	7	5
800 - 850	5	5	5	5	6	6	10	8	5	5
850 - 900	7	5	6	5	5	5	7	7	7	5
900 - 950	6	6	7	8	6	6	10	13	11	12
950 - 1000	11	16	16	16	15	13	13	15	13	15
1000 - 1050	16	16	13	17	12	16	18	15	14	15
1050 - 1100	11	12	15	16	17	10	10	11	12	12
1100 - 1150	10	12	17	19	20	22	25	18	16	18
1150 - 1200	20	20	20	23	21	23	22	25	25	18
1200 - 1250	20	23	25	21	23	19	22	23	28	30
1250 - 1300	20	20	24	21	25	26	27	28	28	20
1300 - 1350	30	35	39	28	25	38	39	40	23	22
1350 - 1400	25	31	27	28	37	22	38	30	28	40
1400 - 1450	39	35	38	33	33	37	46	38	38	34
1450 - 1500	38	36	40	38	40	45	43	38	31	27
1500 - 1550	25	30	35	30	17	16	16	16	14	13
1550 - 1600	14	18	23	18	22	24	21	22	25	27
1600 - 1650	26	30	68	53	38	15	9	9	14	15
1650 - 1700	7	10	12	15	32	25	20	18	15	18
1700 - 1750	47	44	50	50	51	60	71	70	60	60
1750 - 1800	90	18	14	18	24	26	48	40	28	28
1800 - 1850	28	50	106	110	100	99	100	49	60	95
1850 - 1900	92	100	76	66	100	40	38	40	40	42
1900 - 1950	47	43	42	50	67	78	81	93	55	35
1950 - 2000	93	103	103	85	101	75	97	75	45	85
2000 - 2050	90	90	97	98	100	120	120	43	41	44
2050 - 2100	45	73	73	70	80	108	165	120	75	70
2100 - 2150	103	136	140	160	167	80	100	137	122	100
2150 - 2200	135	Cored								
2200 - 2250	Cored		50	82	80	92	72	115	140	145
2250 - 2300	52	74	103	112	80	135	195	45	70	110
2300 - 2350	130	140	85	80	110	108	127	110	37	42
2350 - 2400	32	50	45	48	82	75	68	62	70	58
2400 - 2450	95	77	32	34	37	60	38	52	25	25



CORING TIME

Minutes per foot

2155 - 2160	30	33	17	28	39	30	11	15	27	29
2160 - 2170	30	33	17	28	39	30	11	15	27	29
2170 - 2180	29	26	42	43	39	23	27	30	28	27
2180 - 2190	31	30	29	30	28	14	12	20	16	15
2190 - 2200	19	15	24	31	20	25	20	34	35	33
2200 - 2206	41	35	20	37	29	41				

ADMINISTRATIVE / SUNDRY REPORTS



STATE FILE NO. PERM NO.

WELL COMPLETION OR RECOMPLETION REPORT AND LOG

FARM OR LEASE NAME

Lari Larrow
WELL NO.

TYPE OF COMPLETION

Oil Well Gas Well Dry Hole
 New Well Work-Over Deepen Plug Back Same Zone Diff Zone

FIELD AND POOL OR WILDCAT

Miscat
NO. ACRES IN LEASE

OPERATOR

George Dolezal, Jr.

ADDRESS

1121 Lower Building, Denver, Colorado 80202

LOCATION (in feet from nearest lines of section or legal subdivision where possible)

Surface 660' FSL - 660' FSL

Top prod. interval

At total depth

SEC. TWP. RGE.

30, 05, Sec. 2-270-R11
COUNTY

Fall River

PERMIT NO.

DATE ISSUED

PREVIOUS PERMIT NO.

DATE ISSUED

661

July 1, 1964

DATE STOPPED

July 24, 1964

DATE T. D. REACHED

August 19, 1964

DATE COMPL. (Ready to Prod.)

ELEVATIONS (DF, BKID, RT, GH, etc.)
292' Jrd. - 2207'

ELEV. CASINGHEAD FLGE

TOTAL DEPTH (MD & TVD)

PLUG BACK T. D. (MD & TVD)

IF MULTIPLE COMPL. HOW MANY

INTERVALS DRILLED BY

ROTARY TOOLS

CABLE TOOLS

PRODUCING INTERVALS, THIS COMPLETION, TOP, BOTTOM, NAME (MD & TVD)

1-5' to 2-44' 0 to 1-5'

DATE DIRECTIONAL SURVEY SUBMITTED

None

TYPE ELECTRIC AND OTHER LOGS RUN (Circle those filed)

Gamma ray - Sonic and Dual Induction - Laterolog

WAS WELL CURED

Yes

CASING RECORD (Report all strings set in well)

CASING SIZE	DEPTH SET (MD)	HOLE SIZE	WEIGHT LBS. FT.	PURPOSE	SACKS CEMENT	AMOUNT PULLED
8-5/8"	142'	11"	24	Surface	60	None

LINER RECORD

SIZE	TOP (MD)	BOTTOM (MD)	SACKS CEMENT	SCREEN (MD)	SIZE	DEPTH SET (MD)	PACKER SET (MD)

TUBING RECORD

DEPTH INTERVAL (MD)	PERFORATION RECORD HOLES PER FT.	SIZE AND TYPE	PURPOSE	ACID, SHOT, FRAC, CEMENT SQUEEZE, Etc. AMOUNT AND KIND OF MATERIAL USED	DEPTH INTERVAL (MD)

PRODUCTION

DATE FIRST PRODUCTION: PRODUCING METHOD (Flowing, gas lift, pumping, size & type of pump) WELL STATUS (Prod. or Shut-in)

DATE OF TEST (HOURS TESTED) CHOKED SIZE (PRODUCTION FOR TEST) OIL, Bbls. GAS, Mcf. WATER, Bbls. & % OIL GRAVITY-API (Coff)

FLOW TUBING PRESSURE CASING PRESSURE CALCULATED 24-HOUR RATE OIL, Bbls. GAS, Mcf. WATER, Bbls. & % GAS-OIL RATIO

DISPOSITION OF GAS (Sold, used for fuel, vented, etc.) TEST WITNESSED BY

LIST OF ATTACHMENTS

Two copies final well completion report by G. D. Ayres, including sample descriptions, etc.

I hereby certify that the foregoing and attached information is complete and correct as determined from all available records

SIGNED

George Dolezal, Jr.

TITLE

Owner

DATE

Aug. 27, 1964

DO NOT WRITE BELOW THIS LINE *See Instructions On Reverse Side

Approved 1/11/64 Date

OIL AND GAS BOARD OF THE STATE OF SOUTH DAKOTA

Secretary

8 51 64
30 A. this need

INSTRUCTIONS

General: This form is designed for submitting a complete and correct well completion report and log on all types of leases and leases to either a Federal agency or a State agency, or both, pursuant to applicable Federal and/or State laws and regulations. Supplemental instructions by local Federal and/or State offices will govern the use of this form. If not filed prior to the time this summary record is submitted, copies of all currently available logs (drillers, geologists, seismic and core analysis, all types electric, etc.), formation and well logs, and geophysical surveys, should be attached hereto, to the extent required by applicable Federal and/or State laws and regulations. All attachments should be filed with the well log.

If this well was directionally drilled, show both the location at the surface and at total depth from nearest lines, where possible; also show the locations at the top and at the bottom of any zone for which production data are reported in space 23, and any zone open for injection or disposal. Use this reverse side if more space is needed. (MD-Measured Depth, TVD-True Vertical Depth)

*Indicate which elevation is used as reference (where not otherwise shown) for depth measurements given in other spaces on this form and in any attachments.

If this well is completed for separate production from more than one zone (multiphase completion), so state in the correct space and show the producing interval, or intervals, top(s), bottom(s) and name(s) (if any) for only the zone reported in the blank under PRODUCTION. Submit a separate completion report on this form for each interval (mine) to be separately spaced. Comment: Attached supplemental records for this well should show the details of any multiple stage cementing and the location of the cementing tool.

File 3 copies of this form with Secretary, Oil and Gas Board, Pierre.

SUMMARY OF WATER ZONES AND NON-COMMERCIAL OIL OR GAS ZONES (Note: If well was directionally drilled, show both measured and true vertical depths for zones and markers listed)				GEOLOGIC MARKERS		
KIND OF FORMATION	DEPTH TO TOP		CONTENTS; PRODUCTIVE RATE, IF KNOWN	NAME	DEPTH TO TOP	
	MEAS. DEPTH	TRUE VERT. DEPTH			MEAS. DEPTH	TRUE VERT. DEPTH
				Dakota	120'	
				Fuson	300'	
				Lakota	350'	
				Morrison	425'	
				Sundance	650'	
				Speartfish	918'	
				Goose Egg	1240'	
				Minnekahta	1479'	
				Opeche	1520'	
				Minnelusa	1616'	
				"Red Marker"	2032'	



STATE AND CO. NUMBER

PLUGGING RECORD

Operator <u>George Dolezal, Jr.</u>		Address <u>1121 Tower Building, Denver, Colorado</u>		
Name of Lease <u>Carl Farrow</u>		Well No. <u>1</u>	Field & Reservoir <u>Mildcat</u>	
Location of Well <u>C - 33rd St. Section 2 - 2 Wells</u>		Sec-Twp-Rge or Block & Survey		County <u>Fall River</u>
Application to drill this well was filed in name of <u>George Dolezal, Jr.</u>	Has this well ever produced oil or gas <u>No</u>	Character of well at completion (initial production): Oil (bbls/day) _____ Gas (MCF/day) _____ Dry? <u>Yes</u>		
Date plugged <u>August 19, 1964</u>	Total depth <u>2,477'</u>	Amount well producing when plugged: Oil (bbls/day) _____ Gas (MCF/day) _____ Water (bbls/day) _____		
Name of each formation containing oil or gas. Indicate which formation open to well-bore at time of plugging	Fluid content of each formation	Depth interval of each formation	Size, kind & depth of plugs used. Indicate zones squeeze cemented, giving amount cement.	

CASING RECORD

Size pipe	Run in well (ft.)	Pulled out (ft.)	Left in well (ft.)	Give depth and method of parting casing (shot, ripped, etc.)	Packers and Staves
<u>3-5/8"</u>	<u>142'</u>	<u>NONE</u>	<u>142'</u>		

Was well filled with mud-filtered fluid, according to regulations? Yes Indicate if open formation containing fresh water

In addition to other information required on this form, if this well was plugged back for use as a fresh water well, give all pertinent details of plugging operations, to base of fresh water sand, perforated intervals to fresh water sand, name and address of surface owner, and attach letter from surface owner authorizing completion of this well as a water well and agreeing to assume full liability for any subsequent plugging which might be required.

USE REVERSE SIDE FOR ADDITIONAL DETAIL

Executed this the 27th day of AUGUST, 1964

State of COLORADO
County of DENVER

George Dolezal, Jr.
Signature of Affiant

Before me, the undersigned authority, on this day personally appeared George Dolezal, Jr. known to me to be the person whose name is subscribed to the above instrument, who being by me duly sworn on oath states, that he is duly authorized to make the above report and that he has knowledge of the facts stated therein, and that said report is true and correct.

Subscribed and sworn to before me this 27th day of AUGUST, 1964

SEAL My commission expires May 26, 1968

Notary Public in and for State of Colorado
County, State of Colorado

DO NOT WRITE BELOW THIS LINE

Approved _____ Date _____ OIL AND GAS BOARD OF THE STATE OF SOUTH DAKOTA
Secretary

See Instructions On Reverse Side

Approved for release of bond
Date March 7, 1965
Thomas J. McHugh
Geologist



CORRESPONDENCE



POWERTECH (USA) INC.

49 of 63

FEB 19 1965



**SOUTH DAKOTA
STATE GEOLOGICAL SURVEY**

**SCIENCE CENTER
University of South Dakota Campus
VERMILION 57000
Phone 685-4471**

**DUNCAN J. MCGREGOR
Director and State Geologist
MERLIN J. TIPTON
Assistant State Geologist**

**Western Field Office
Belle Fourche, South Dakota
February 18, 1965**

**Dr. Duncan McGregor
State Geologist
Vermillion
South Dakota**

**Re: Dolezal #1 Darrow
SEM-2-7S-1E
Fall River County, South Dakota
Permit No. 361**

Dear Duncan:

The six month confidential period on the above test terminates today, and all information may now be released to anyone wanting it.

The marker pipe has been placed and the mud pits satisfactorily filled and smooth. My file indicated that all required logs and records have been sent in by Mr. Dolezal.

If you have received the samples of this test, I believe the bond can be released.

Sincerely,

**Earl Cox
Engineering-Petroleum Geologist**

EC:sn

cc: Secretary, Oil and Gas Board

February 18, 1965

Mr. Earl Cox
State Geological Survey
P. O. Box 208
Belle Fourche, South Dakota

Dear Earl:

On February 9, 1965, we received from Amstrat the following samples:

Phillips Petroleum #1-"A" Njos, Sec. 34, T. 23 N., R. 3 E.,
Harding County; core and intervals 50-3270, 3270-6330,
6330-9620.

✓ Sun Oil et al #1 Earl Darrow, Sec. 2, T. 7 S., R. 1 E., Fall
River County; core and interval 150-2450.

Consolidated Royalty #1 Wulf-Ideen-USA, Sec. 15, T. 8 S.,
R. 2 E., Fall River County; interval 0-2472.

Mule Creek #1-4410 Clark, Sec. 10, T. 8 S., R. 9 E., Fall
River County; interval 186-2871 and 1 box cores.

Colonial Oil Co. #1 Howard Bailey, Sec. 18, T. 9 S., R. 8 E.,
Fall River County; interval 220-2692.

Today in the mail we received notice of shipment on February 16,
1965, of the following samples: 1 box, Consolidated Royalty Oil et
al #1 Ideen-Federal, SW SW 15-88-2E, Fall River County. We have
not yet received this shipment.

Sincerely yours,

LJ

Merlin J. Tipton
Assistant State Geologist

MJT:jmd

November 13, 1964

Mr. Earl J. Cox
State Geological Survey
Box 208
Belle Fourche, South Dakota

Dear Earl:

I am enclosing a copy of the Dual Induction-Laterolog and
Sonic Log-Gamma Ray for Dolesal #1 Darrow, Fall River County,
Sec. 2, T. 7S, R. 1E.

Sincerely yours,



(Mrs.) Donna Jean Hedges
Administrative Assistant

For the State Geologist

Done West by Air

Enclosures

NOV 5 52 1964



SOUTH DAKOTA
STATE GEOLOGICAL SURVEY

SCIENCE CENTER
University of South Dakota Campus
VERMILLION 57000
Phone 684-4471

DUNCAN J. MCGREGOR
Director and State Geologist
MERLIN J. TIPTON
Assistant State Geologist

Western Field Office
Belle Fourche, South Dakota
November 4, 1964

Dr. Duncan McGregor
State Geologist
Vermillion
South Dakota

Re: Dolezal #1 Darrow
SE $\frac{1}{4}$ SE $\frac{1}{4}$ -2-7S-1E
Fall River County, South Dakota
Permit No. 361

Dear Duncan:

Enclosed for your files is one copy each of the following
logs: sonic-gamma ray, dual induction-laterolog, formation
tester.

Sincerely,

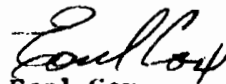

Earl Cox
Engineering-Petroleum Geologist

EC:cr



POWERTECH (USA) INC.



SOUTH DAKOTA
STATE GEOLOGICAL SURVEY

SCIENCE CENTER
University of South Dakota Campus
VERMILLION 57000
Phone 694-4471

Western Field Office
Belle Fourche, South Dakota
September 22, 1964

SEP 23 1964

DUNCAN J. MCGREGOR
Director and State Geologist
MERLIN J. TIPTON
Assistant State Geologist

Dr. Duncan McGregor
State Geologist
Science Center
Vermillion, South Dakota

Re: Delezel #1 Darrow
SE $\frac{1}{4}$ SE $\frac{1}{4}$ -2-7S-1E
Fall River County
South Dakota
Permit No. 361

Dear Duncan:

The pits have been filled and the marker pipe placed at the above location.

After the samples have been received, it would seem that the bend can be released on this test.

Sincerely,

Earl Cox
Engineering-Petroleum Geologist

EC:cr

Western Field Office
Belle Fourche, South Dakota
September 1, 1974

Mr. George Dolezal, Jr.
Tower Building
1700 Broadway
Denver 2, Colorado

RE: Dolezal #1 Darrow
SE₄ NE₄ -2-7-1E
Fall River County
South Dakota
Permit No. 361

Dear Mr. Dolezal:

I see details of the above test have been released to
Rinehart's.

If information from this test is no longer confidential,
I would appreciate you writing me to this affect.

Sincerely,



Earl Cox
Engineering-Petroleum Geologist

EC:cr



SOUTH DAKOTA
STATE GEOLOGICAL SURVEY

SCIENCE CENTER
University of South Dakota Campus
VERMILLION 57069
Phone 624-4471

DUNCAN J. MCGREGOR
Director and State Geologist
MERLIN J. TIPTON
Assistant State Geologist

Western Field Office
Belle Fourche, South Dakota
August 21, 1964

Mr. George Dolezal, Jr.
1121 Tower Building
Denver 2
Colorado

RE: Dolezal #1 Barrow
14 SE₄-2-7S-1E
Fall River County
South Dakota
Permit No. 361

Dear Mr. Dolezal:

I have received from Schlumberger one copy of logs run on the above test.

We require two copies of all logs and records on oil or gas tests. Logs and records are required within 30 days of completion of the test. This letter is only to inform you of the status of our records at this time.

I appreciate the cooperation given by Mr. Ayres and hope you plan additional work in South Dakota.

Sincerely,

Earl Cox
Engineering-Petroleum Geologist

EC:cr

cc: Duncan McGregor



POWERTECH (USA) INC.



56 of 63

SOUTH DAKOTA
STATE GEOLOGICAL SURVEY

SCIENCE CENTER
University of South Dakota Campus
VERMILLION 57000
Phone 605-4471

Western Field Office
Belle Fourche, South Dakota
August 20, 1964

DUNCAN J. MCGREGOR
Director and State Geologist
MERLIN J. TIPTON
Assistant State Geologist

Dr. Duncan McGregor
State Geologist
Vermillion
South Dakota

RE: Dolezal #1 Darrow
SE $\frac{1}{4}$ SE $\frac{1}{4}$ -2-7S-1E
Fall River County
South Dakota
Permit No. 361

Dear Duncan:

We have been asked to keep information on this test confidential for the six months period, unless released sooner by the operator.

Sincerely,

Earl Cox
Engineering-Petroleum Geologist

EC:cr

JUL 8⁵⁷ 1963 1964

SOUTH DAKOTA

State Water Resources Commission

STATE OFFICE BUILDING
PIERRE, SOUTH DAKOTA

July 7, 1964

Mr. Earl Darrow
Dewey, South Dakota

Dear Sir:

I have been advised that ~~Mr~~ George Dalezal, Jr., ^{121 Tower Bldg. Denver,} has obtained a Permit to Drill for Oil and Gas on your land in Section 2, T 7 S, R 1 E.

Occasionally, owners of land consider converting abandoned oil wells into water wells. Please advise me whether or not you intend to convert the oil well drill hole on your land into a water well if water is encountered and the drill hole is abandoned as an oil well.

If you are considering making a water well out of the abandoned oil well drill hole, special considerations are necessary to comply with the State's oil and water laws. The abandoned oil hole must be properly plugged and the water well properly constructed. All conversion work will be at your expense. The cost will vary, depending upon the characteristics of the drill hole, but such cost will be in the neighborhood of \$5,000 or more. Usually another driller and drill rig will have to be arranged for. This other drill rig and casing and other materials will have to be on hand to take over immediately after the special oil well plugging is completed, because the drill hole cannot be left open for any appreciable length of time without spoiling it. Approval of plans for construction of the water well will be required, and a bond covering proper construction may be required. Also, a water right may be required. All of these arrangements take considerable time to accomplish.

Please advise me immediately if you plan to convert the oil well drill hole into a water well. We both hope that a producing oil well results from the drill hole on your land; however, if not and you are planning on a water well, we must start making arrangements now.

Sincerely,

J.W. GRIMES
Chief Engineer

JWG/bw

cc State Geologist
Oil & Gas Board



SOUTH DAKOTA
STATE GEOLOGICAL SURVEY

SCIENCE CENTER
University of South Dakota Campus
VERMILLION 57000
Phone 624-4471

DUNCAN J. MCGREGOR
Director and State Geologist
MERLIN J. TIPTON
Assistant State Geologist

Western Field Office
Belle Fourche, South Dakota
July 6, 1968

Mr. George Dolezal, Jr.
1121 Tower Building
Denver 2, Colorado

RE: Dolezal #1 Darrow
SE $\frac{1}{4}$ SE $\frac{1}{4}$ -2-7S-1E
Fall River County, South
Dakota
Permit No. 361

Dear Mr. Dolezal:

The Secretary of the Oil and Gas Board has forwarded me a copy of your approved permit to drill a test. This will be an interesting test and we will watch it with interest.

During the drilling of oil tests in the State, I scout them periodically. Our Rules require the use of a blow-out preventer, on wildcat tests as spelled out in Paragraph 2, Section A, Page 10, of the Rules and Regulations which states:

"In all unproven areas, (wildcat wells) all drilling wells shall be equipped with a mastergate, or its equivalent, an adequate blow-out preventer, together with a flow line valve of the proper size and working pressure. The entire control equipment shall be in good working condition at all times."

It is a pleasure to welcome you to South Dakota and wish you success in your test.

Sincerely,

Earl Cox
Engineering-Petroleum Geologist

EC:cr

Cc: Secretary Oil and Gas Board
State Geologist ✓

SURETY

**NO SURETY INFORMATION FOR
THIS WELL AS OF 5/18/2011**

MISCELLANEOUS



Buffalo Times Herald

August 13, 1964

8-13-64
**STATE OIL DRILLING
ACTIVITY ON INCREASE**

Oil well drilling activity in South Dakota is expected to increase with the granting last week of four permits. Dr. Duncan McGregor, State Geologist, reports that the Oil and Gas Board has granted permits to the Consolidated Royalty Company, Casper, Woming, for two tests in Fall River county. One test, the No. 1 Ideen-Federal, is three miles southwest of Edgmont on the H. C. Porter ranch. The test will reach an estimated depth of 3300 feet and test the Leo sands of the Minnelusa Formation. The other permit to Consolidated is located eight miles southeast of Edgemont on the Kenneth Helsel ranch, and will also test the Leo sands.

Drilling continues on the Dolezal No. 1 Darrow test, and had reached a depth of 1700 feet on August 6. The test is located fourteen miles northwest of Edgemont.

Gulf Oil has been granted two permits. One location is nine miles southeast of Murdo, on the Don Hight ranch. The other is twelve miles south of Murdo on the Russell Olson ranch. On August 10 the Olson test was in the process of being drilled, but no further information was being released at that time.

Buffalo Times Herald



VOICE

AMERICAN STRATIGRAPHIC COMPANY

1820 BROADWAY, DENVER · 524 E. YELLOWSTONE, CASPER · 17 NO. 31ST ST. BILLINGS

February 1, 1965

NC 1786

P. O. No.

South Dakota State Geological Survey
Attn: Dr. Duncan McGregor
Science Center
University of South Dakota
Vermillion, South Dakota

SOUTH DAKOTA WELLS N/C

- 3 Boxes
- 1 Box
- 1 Box
- 1 Box
- 1 Box

Phillips #1-A Njos, 34-23N-3E, Harding Co.
 Sun Oil et al, #1 Earl Darrow, 2-7S-1E, Fall River Co.
 Consolidated Royalty #1 Wolf-Ideen-USA, 15-8S-2E, Fall River Co.
 Mule Creek #1-4410 Clark, 10-8S-9E, Fall River Co.
 Colonial Oil Co., #1 Howard Bailey, 18-9S-6E, Fall River Co.

N/C

*Shipped by
United Buckingham*

2-9-65



Oil and Gas Search for: <i>api_no_ like '40 047 05147'</i>		
Page 1 of 1	<u>Download Database</u> (Excel spreadsheet format)	Page: 1

Record 1 of 1

Well Information

API No:	40 047 05147	County:	FALL RIVER
Well Name:	CONROY 1 PETERSON	Location:	NWSE 22-7S-1E
Permit No:	408	Total Depth:	2400
Operator Name:	CONSOLIDATED ROYALTY OIL CO	Bottom Hole:	Minnelusa
Permit Date:	11-22-1965	KB Elevation:	3533
Spud Date:	12-11-1965	Ground Elevation:	3522
Plug Date:	12-24-1965	Latitude:	43.429674
		Longitude:	-103.983142
Well Field	WILDCAT	Status	P&A
Class:	DRY HOLE	Type:	DRY HOLE

Formation Tops

<u>Formation</u>	<u>Depth (ft.)</u>
Minnekahta	1610
Minnelusa	1690
Converse	1741
Red Marker	2158
2nd Leo	2290

Page 1 of 1 (goto top)	Page: 1
---	----------------

COUNTY: **FALL RIVER**
LEGAL LOCATION: **NWSE 22-7N-1E**
API NO: **40 047 05147**
PERMIT NO: **408**
WELL NAME: **CONROY #1 PETERSON**
OPERATOR: **THE CONSOLIDATED
ROYALTY OIL COMPANY**
PERMIT ISSUED: **11/22/1965**
PERMIT CLOSED: **06/14/1966**
FILE LOCATION: **7N-1E-22 NWSE**

TARGET CODES:

WELL HISTORY / CHECKLIST

PERMIT TO DRILL / INTENT TO DRILL

WELL INSPECTION / SCOUT REPORTS

OPERATOR'S TECHNICAL REPORTS / MAPS

ADMINISTRATIVE / SUNDRY REPORTS

CORRESPONDENCE

SURETY

MISCELLANEOUS

WELL HISTORY / CHECKLIST

WELL HISTORY

Well Name Conroy #1 Paterson Permit No. 408

Location NWSE 22-7S-1E Fall River Date of Permit 11-22-65

Elev. 3522 Gr. API No. _____

Confidential _____ From _____ To _____

Logs Received _____

Cuttings Received _____ Cores Received _____

Drill Stem Records _____

Cap Plug and Marker Set 12-28-65

Surface Restored 12-28-65

Plugging Affidavit Signed _____ Date _____

Bond Released _____ Date 6-14-66

Summary of Scout Reports

12-16-65 First visit Spudded 12-11-65

12-24-65 Plugged

12-28-65 Marker in place - pits filled and location smoothed

PERMIT TO DRILL / INTENT TO DRILL

State Pub. Co. Pierre **APPLICATION FOR PERMIT TO:** S. Dak. Oil & Gas Board FORM 2

<input checked="" type="checkbox"/> DRILL	<input type="checkbox"/> DEEPEN	<input type="checkbox"/> PLUG BACK	FARM OR LEASE NAME F. A. Peterson
<input type="checkbox"/> OIL WELL	<input type="checkbox"/> GAS WELL	<input type="checkbox"/> SINGLE ZONE	WELL NO. No. 1
<input type="checkbox"/> MULTIPLE ZONE			FIELD AND POOL OR WILDCAT Wildcat
OPERATOR THE CONSOLIDATED ROYALTY OIL COMPANY			NO. ACRES IN LEASE 1840 acres
ADDRESS P. O. Box 605 Casper, Wyoming 82602			SEC. TWP. RGE C 14 S 22 E Section 22-7S-1E
LOCATION (in feet from an established corner of the legal subdivision) 1980' from East Line and 1980' from South Line of Section 22, Township 7 South, Range 1 East, B.H.M.			COUNTY Fall River

NAME AND ADDRESS OF SURFACE OWNER Francis A. Peterson P. O. Box 5, Burdock, South Dakota	ELEVATION 3522' PROPOSED DEPTH 2600'	NO. OF WELLS ETC One (1) ROTARY OR CABLE TOOLS Rotary
NAME AND ADDRESS OF CONTRACTOR Bullock and Barnhart P. O. Box 2426 Casper, Wyoming 82602	APPROXIMATE DATE WORK WILL START November 15, 1965	
IF LEASE PURCHASED WITH ANY WELLS DRILLED, FROM WHOM PURCHASED (Name and address) None		

PROPOSED CASING AND CEMENTING PROGRAM

SIZE OF HOLE	SIZE OF CASING	WEIGHT PER FOOT	NEW OR SECOND HAND	DEPTH	SACKS OF CEMENT
12-1/4"	8-5/8"	24 lb.	New	1050'	750

We plan to set surface casing in Spearfish formation to shut off anticipated water flows from the Dakota and Sundance formations.

DESCRIBE PROPOSED OPERATIONS. IF PROPOSAL IS TO DEEPEN OR PLUG BACK, GIVE DATA ON PRESENT PRODUCTIVE ZONE AND PROPOSED NEW PRODUCTIVE ZONE. GIVE BLOW OUT PREVENTER PROGRAM IF ANY

Blow Out Preventer: Schaffer 12" Series 900 Mechanical doublegate.

A 7-7/8" hole will be drilled from the base of the surface casing to total depth. In the event oil or gas production is indicated, either 4-1/2" or 5-1/2" casing will be set through the productive zone or zones and cemented with an appropriate amount of cement. In the event this test is abandoned then the hole will be plugged in accordance with the Regulations of the State Oil and Gas Board.

Anticipated Formation Tops: Dakota 205'; Lakota 398'; Sundance 687'; Basal Sundance 996'; Goose Egg 1295'; Minnekahta 1537'; Opeche 1578'; Minnelusa 1615'; Converse Anhydrite 1742'; Red Marcker 2130'; 2nd Leo 2255'.

SIGNED: *[Signature]* TITLE: President DATE: November 17, 1965

DO NOT WRITE BELOW THIS LINE

PERMIT NO. *[Blank]* CHECKED BY: *[Signature]* School and Public Lands Date: 11/19/65

APPROVAL DATE: *[Blank]* Ann Heckworth, Assistant Secretary

CONDITIONS

COMPLETE SET OF SAMPLES, AND CORES IF TAKEN, MUST BE SUBMITTED.

SAMPLES, AND CORES IF TAKEN, BELOW DEPTH, MUST BE SUBMITTED.

INSTRUCTIONS

General: This form is designed for submitting proposals to perform certain well operations, as indicated, on all types of lands and leases for appropriate action by either a Federal or a State agency, or both, pursuant to applicable Federal and/or State laws and regulations. Consult applicable Federal or State regulations, or appropriate officials, concerning approval of the proposal before operations are started.

If the proposal is to re-drill to the same reservoir at a different subsurface location or to a new reservoir, use this form with appropriate notations.

If the well is to be, or has been, directionally drilled, so state and show by attached sheets, if necessary, the coordinate location of the hole in any present or objective productive zones.

File 3 copies of this form with Secretary, Oil & Gas Board, Pierre.

(*Sample location: 600' South and 600' East of the Northwest Corner of Section 16.)



SECTION 22 T.7S.-R.1E., BLACK HILLS MER. FALL RIVER COUNTY, SOUTH DAKOTA

N.

SCALE
1" = 20 Chains.
DISTANCES ARE EXPRESSED IN CHAINS EXCEPT AS INDICATED.

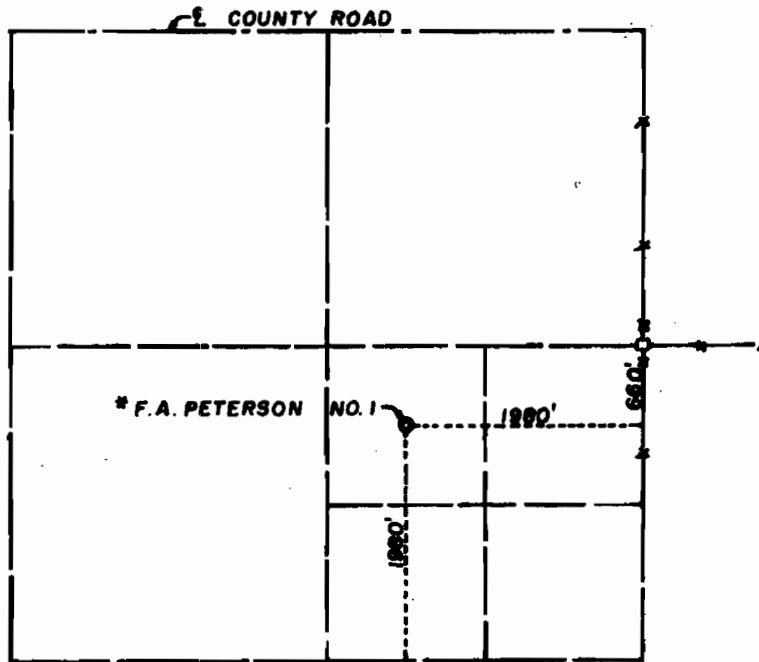

LEGEND

- U.S. Government Brass Cap Corner.....○
- Original stone corner, properly marked, firmly set.....●
- Iron pipe set of proportionate distance.....■
- Corner established by others as indicated.....□
- Dependent Resurvey.....=
- Protraction.....-
- Well location.....●

ELEVATIONS:
Before grading

LOCATION	3522
R. P. 100' N.	3521
R. P. 100' S.	3522
R. P. 100' E.	3522
R. P. 100' W.	3522

ELEV'S. REFERRED TO:
U.S.G.S. BM TT1 WBR 1949
Elev. 3563

SURVEY AND PLAT BY
WORTHINGTON, LENHART & ASSOCIATES, INC.
200 South Lowell St., Casper, Wyoming
Direct solar lines and chained distances. Ref. Book No. 205, R 08

**PLATTED FIELD NOTES OF SURVEY
MARKING WELL LOCATION
NW $\frac{1}{4}$ SE $\frac{1}{4}$, SECTION 22
FOR**

CON ROY - SUN - FROST, CASPER, WYOMING



William G. Ladd
Certified true and correct copy of
SOUTH DAKOTA 1888 L.S.

10-29-1996
10-29-98

* Revised 11-4-'85

JWG



WELL INSPECTION / SCOUT REPORTS

Permit No. 408

STATE GEOLOGICAL SURVEY

Scout Report

Date Scouted 12-28-65

Owner ConRoy

Designation of well #1 Peterson

Location: Sec. 22 T. 7 N. S. R. 1 E. W.

Fall River County, S. D. Total depth 2400 feet

Casing Record:

14 30 Ft. Ft.

8 5/8 1125 Ft. Ft.

Work in progress at time of visit:

None.

Developments since last visit:

Abandonment marker in place. Pits filled and location smoothed.

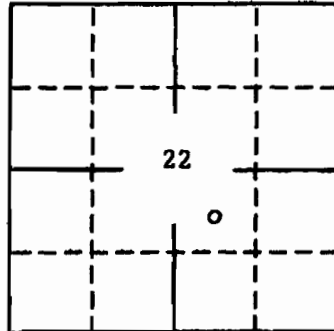

Remarks and recommendations:

Rig stacked at location.

Scouted by Earl Cox, Geologist

Approved by *Duncan J. McGregor*
Duncan J. McGregor, State Geologist

Permit No. 408

STATE GEOLOGICAL SURVEY

Scout Report

Date Scouted 12-24-65

Owner ConRoy

Designation of well #1 Peterson

Location: Sec. 22 T. 7 N. S. R. 1 E. W.

Fall River County, S. D. Total depth 2400 feet

Casing Record:

14 30 Ft. _____ Ft.
8 5/8 1125 Ft. _____ Ft.

Work in progress at time of visit:
Plugged as follows:
1925 - 1850 25 sacks 3rd Converse
1195 - 1120 25 sacks Base Surface casing.

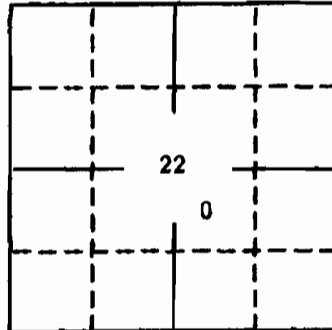

Developments since last visit:

Run Dual Induction and Sonic Gamma Ray log
AmStrat will process samples
No cores taken, no shows observed, no tests run.

Remarks and recommendations:

Sample tops:
Minnekahtha - 1610
Minnelusa - 1690
2nd Converse - 1741
3rd Converse - 1871
4th Converse - 2020
Red Marker - 2158
2nd Leo - 2290 (tite - no shows)

Scouted by Earl Cox, Geologist

Approved by Duncan J. McGregor, State Geologist



Permit No. 408

STATE GEOLOGICAL SURVEY

Scout Report

Date Scouted 12-16-65

Owner ConRoy

Designation of well #1 Peterson

Location: Sec. 22 T. 7 N. S. R. 1 E. W.

Fall River County, S. D. Total depth 1140 feet

Casing Record:

14" 30 Ft. Ft.

8 5/8 1125 Ft. Ft.

Work in progress at time of visit:
Had just finished cementing surface casing.

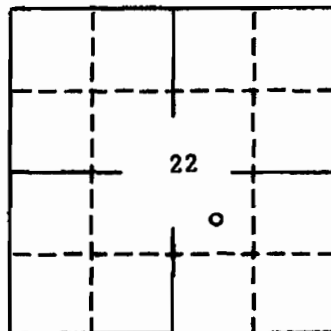

Developments since last visit:

Spudded: 12-11-65

Set 30 feet of 14" conductor pipe with 11 sacks.

Set 1125 feet of 8 5/8 surface casing at 1136 with 850 sacks.

Slight flow from basal Sundance that was controlled with heavy mud.

Remarks and recommendations: Sample tops:

- Dakota 260
- Lakota 460
- Morrison 560
- Sundance 750
- Spearfish 1122

Elevation: 3522 gd.
3533 K. B.

Scouted by Earl Cox, Geologist

Approved by *Duncan J. McGregor*
Duncan J. McGregor, State Geologist



Cooksey #1 Peterson

1980 FEL, 1980 FSL.
NWSE - 22-75-1E
Fall River.

Bullock & Burdick
Casper.

Francis A. Peterson
Burdock, S. Dak.

Elev: 3522 9d.
3533 K.B.

Est T.D. 2600
(1050' Surface)

Permit: 11-22-65 # 408

Slight flow from Sandstone.

Flow estimated 500 g.p.m. in
base.

12-23-65

Casper called 6:00 p.m. Keady
to log & then plug. Peterson
wants surface plug left off for
pass. to use as a water
well. Et Bourdick said would
sewer marker on but not
cement.

12-24-65

Plugged.
1925-1850 25' at 3rd Cas.
1195-1120 25' at Base

Sample tops:
mk 1610
mk 1690
2nd Cas. 1741
3rd Cas. 1871
4th Cas. 2000
Red Mbr. - 2158
Drilled 2290 Tite-in House
T.D. 2400 1999

12-16-65 12 of 48

Spud: 12-10-65

~~Drilled~~

Set 14" Casing at 30'
& Cemented with 11AT.

Drilled 13 3/4' hole to 1140'

Sample top:

Dak 260
Loh 460
Mow 560
Sun 750

Top Sp 1122

Run 1125-36' 8 3/4" J.C.
Set #1136-36' w/85004
Good Return.
JWOC 12:30 12-16-65

run casing, test on show

Run steel induction &
Sonic Gamma ray Caliper

Cas Street will process sample

12-28-65

Marker in Ok. pits filled
& variation 0-100 ft.
Rig Staked at location

3-9-66

Vermillion kind Sample



API ID 40 047 05147

2130146 # 408

Con-roy #1 Retention

CNW 1/4 SE 1/4 Sec. 22, T 15, R 1E
Hall Stearns Co.

Spudded 12-11-65
Elev 3522 gal
Steel
Connector

12-16-65

Set 30' of 14" csg to 1125' of 8 7/8"
@ 1130 feet. Slight flow from base
of sandstone controlled with mud.
Logs: Kd 260, K1-460, Manna-500,
Lubrock-750, Spicoful 1122,
12-24-65

Spudded to 2400 & plugged.
Red lead and 4 lines - ER. Am
that will process samples. No
cores, tests or shows. Logs: Munnell-1610
Munnellum 1680, 2nd Cor- 1741, 3rd Cor- 1871
4th Cor- 2020, RM-2158, 2nd Cor 2290



API ID 40 047 05147

12-27-68
14 of 48

letter for cost to Allison saying
need request in writing to correct surface
make paper

12-28-68

made in place. Data filled &
smoothed. Rig started



POWERTECH (USA) INC.

WELL: ^{API ID 40 047 05147} *Conroy #1 well* ^{215 of 148}

LOCATION:

LOGS:

TOPS:

GEOLOGIC: *2 logs...*

ELECTRIC, FIELD:

FINAL: *1 local Id-22 (RMU 2)*

RADIO, FIELD:

FINAL: *1 local GR (RMU 2)*

OTHERS:

CUTTINGS RECD: *3-9-66*

CORES RECD:

DRILL STEEL DATA RECD:

CAP PLUG CHECKED: *OK 12-28-65*

MUD PIPES FILLED: *OK 11-29-65*

PLUGGING AFFIDAVIT SIGNED: *1/6/66*

BOND RELEASED: *6-14-66*



OPERATOR'S TECHNICAL REPORTS / MAPS



CONTENTS

SUMMARY	Page 1
GEOLOGIC RECORD	Page 3
Remarks	Page 3
Sample Description	Page 3
DRILLING RECORD	Page 8
Remarks	Page 8
Well History	Page 8
Bit Record	Page 9
Casing Record	Page 9
Mud Program	Page 9
Plugging Record	Page 10
Penetration Rate	Page 11



ConRoy #1 F. A. Peterson
C NE SE 22 T7S R1E
Fall River Co., South Dakota

SUMMARY

Operator: The Consolidated Royalty Oil Company
Name: #1 F. A. Peterson
Location: C NE SE Sec 22, Twp 7 South, Rge 1 East, Fall River
County, South Dakota
Elevation: 3522 GR., 3533 K.B.
Spud: December 10, 1965 Complete: December 24, 1965
Status: Plugged and abandoned
Geologic Record:

<u>Formation</u>	<u>Spl. Top</u>	<u>Schl. Top</u>	<u>Datum</u>
Dakota	260	260	+3273
Fuson	380	383	+3150
Lakota	460	458	+3075
Morrison	520	524	+3009
Sundance	740 ?	753	+2780
Canyon Springs	1110	1106	+2427
Spearfish	1120	1120	+2413
Goose Egg	1420	1371	+2162
Minnekahta	1600	1613	+1920
Opeche	1650	1648	+1885
Minnelusa	1690	1685	+1848
2nd Converse SS	1740	1741	+1792
Converse Anhy	1810	1821	+1712
3rd Converse SS	1870	1870	+1663
4th Converse SS	2020	2024	+1509
Red Marker	2160	2166	+1367
2nd Leo SS	2290	2295	+1238

Total Depth: 2400 2400

Formation Tests: None

Cores: None

Logs: By Schlumberger, Newcastle, Wyoming
Sonic & Cal 5" (1') 1136-2393
Gamma Ray 5" 300-2393
Dual Ind - LL 2" 1136-2394
5" 1136-2394



ConRoy #1 F. A. Peterson
C NE SE 22 T7S R1E
Fall River Co., South Dakota

SUMMARY (Cont'd.)

<u>Drilling Mud:</u>	Mo-Mar Mud Company, Casper, Wyoming
<u>Drilling Contractor:</u>	Barnhart & Bullock Drilling Company, Casper, Wyoming
<u>Geologic Supervision:</u>	James D. Copen, Consulting Geologist, Casper, Wyoming



ConRoy #1 F. A. Peterson
C NE SE 22 T7S R1E
Fall River Co., South Dakota

GEOLOGIC RECORD

Remarks

The test was proposed primarily to investigate a permeability pinch-out of the Second Leo Sandstone member of the Minnelusa. The test was located approximately midway between a down-dip dry hole having 40 feet of permeable sandstone which was wet with a show of oil and two up-dip dry holes, both of which had no permeable sand. One of the up-dip tests had good oil staining in the Second Leo. Secondary objectives were the Canyon Springs member of the Sundance and the several Converse sands of the upper Minnelusa. The test was proposed to drill to a total depth of 2500 feet; or 300 feet below the Red Marker.

In drilling, a normal sequence of formations was encountered. The Second Leo was found to be thin, dolomitic, tight and had no shows. The various Converse sandstones were found to be nicely developed but had no shows. There were no cores or formation tests.

The test was plugged and abandoned at a depth of 2400 feet; approximately 240 feet below the Red Marker.

Sample Description

Samples from the surface hole (0-1140') are generally poor to useless, being predominantly material which was recirculated by the very heavy drilling mud used to control water flows. Samples were caught both from the pilot hole and while reaming. The descriptions below are partly of each, depending on which seemed the most representative. Samples from 1140 to total depth were of uniformly good quality. Sample intervals are 10 feet with the exceptions noted below. The samples are in possession of the American Stratigraphic Company, Billings, Montana.

20' Samples

100-260 Sh - drk gry to blk, fisl; occas silt strk; Pyr

DAKOTA 260

260-300 SS - gry partly mottled blk, wh, fmg, v/firm w/poor to no porosity, occas blk sh prtg, NS; Pyr

Begin 10' Samples

300-310 Sh - gry to brn-blk, partly mottled w/blk carb material;
SS - as abv grdg to Siltst; Pyr



GEOLOGIC RECORD (Cont'd.)

- 310-340 SS - wh to lt gry mottled and banded w/blk, fng, vht, NS;
 little Sh - a/a; Pyr
- 340-360 SS - a/a grdg to v/argill Siltst; little Sh - v/lt gry,
 wxy to silty; few Siderite pellets; Pyr
- 360-370 Same a/a w/free Sd - fmg, NS
- 370-380 Same a/a w/abun free Sd; little SS - clr, fmg, v/fri,
 ex porosity, NS; Pyr

FUSON 380

- 380-420 Sh - lt gry, wh, pale lvndr, wxy; decr SS - a/a
- 420-430 Sh - v/drk gry w/brn cast, wxy
- 430-440 Sh - a/a; Sh - wh, pale grn, wxy
- 440-460 Sh - pale grn to wh, v/sdy, wxy; little Sd - free; Sh a/a

LAKOTA 460

- 460-480 Sd - free, fng, poor sorting; NS; Sh - a/a; Pyr
- 480-500 Same a/a; little Sh - pale grn, sdy grading to SS-pale
 grn, v/argill, NS; Pyr

Begin 20' Samples

- 500-520 SS - fmg, fri, porous, NS; SS - wh, pale grn, v/argill; abun
 free Sd; Sh - brite grn, wh, gry, blk, sdy; entire spl
 balled-up w/gry Bent

MORRISON 520

- 520-560 Sh - blu-grn to brn-gry, wxy; little SS - clr, mcg, v/fri
 & porous, NS; abun free sd
- 560-580 Siltst - dead wh w/thin even bands of blk carb Sh; Sh - blk,
 silty; Ls - drk gry, dns; abun Pyr
- 580-600 Same a/a; Sd - free, mvcg, ang to rd, NS; Pyr
- 600-660 SS - gry, vf-vcg, v/Pyrte, fri, argill, poor porosity, NS;
 Sh - a/a; abun free Sd
- 660-910 Samples this interval were composed 100% of recirculated
 material, one fragment of grn, glauc siltstone observed
 in 740-760 sample is thought to be near the top of the
 Sundance

Resume 10' Samples

- 910-920 Mostly recirc material; Siltst - red-brn, v/argill & soft
- 920-980 SS & Siltst - red-brn to wh, fng, partly w/ex porosity, NS
- 980-1040 SS - lt gry-grn, fmg, partly w/ex porosity, NS; Sh - blu-gry,
 wxy

GEOLOGIC RECORD (Cont'd.)

1040-1090 Sh - blu-gry, wxy, blocky; little SS a/a
1090-1110 Poor samples, apparently same a/a

CANYON SPRINGS 1110

1110-1120 Poor spl; abun free sd - fvcg, clr qtz, lrg frns are
well rdd, NS

SPEARFISH 1120

1120-1140 Same a/a; increasing SS & Siltst - red-brn, vfg, argill,
tite
1140-1150 No sample
1150-1160 Same a/a w/occas Anhy

Begin 20' Samples

1160-1180 Same a/a
1180-1420 Siltst - red-brn a/a grading to Sh of same clr; occas Anhy

GOOSE EGG 1420

1420-1580 Anhy - wh, buff, dns to xln; Siltst & Sh - red-brn
1580-1600 Siltst & Sh - red-brn w/little Anhy

MINNEKAHTA 1600

1600-1640 Ls - wh, pnk, viol, dns; abun Anhy & Sh a/a

Resume 10' Samples

1640-1650 Same a/a

OPECHE 1650

1650-1690 Sh - brite red-brn, earthy; little Ls & Anhy a/a

MINNELUSA 1690

1690-1700 Sh - brite red-brn a/a, partly sdy; Dolo - red-brn, dns;
Anhy - wh, xln
1700-1720 Sh - red-brn a/a, bcmg silty; abun Anhy - wh
1720-1740 Silt & Sh a/a becoming sdy, no porosity, NS; abun Anhy

GEOLOGIC RECORD (Cont'd.)

SECOND CONVERSE SANDSTONE 1740

1740-1746 SS - wh, tan, orng, fmg, argill, tite w/rare porosity, NS;
 Sh & Anhy a/a
 Circ 1746 Same a/a, NS
 1746-1760 Same a/a, NS
 1760-1790 SS - wh, pnk, orng, mcg, ex porosity in part, NS; little
 Sh & Anhy a/a
 1790-1810 SS - a/a to viol, mg, argill & tite, NS; Sh & Anhy a/a

CONVERSE ANHYDRITE 1810

1810-1840 Anhy - wh, buff, dns, xln; Dolo - pnk, viol; Sh - brite
 red w/occas grn mottling; diminishing SS a/a
 1840-1870 Dolo - gry, viol, dns, gran; Anhy & Sh a/a

THIRD CONVERSE SANDSTONE 1870

1870-1876 SS - wh to orng, mg, partly argill, v/fri, fair porosity,
 NS; Sh, Anhy & Dolo a/a
 Circ 1876 Same a/a, NS
 1876-1890 SS - same a/a to red, fmg, v/argill & tite; NS; Sh, Anhy
 & Dolo a/a
 1890-1900 Same a/a w/decr SS
 1900-1940 Dolo - tan, wh, gry mottled blk, dns to gran; little SS,
 Sh & Anhy a/a
 1940-1970 Dolo - a/a w/abun smoky cht; little Anhy & Sh a/a
 1970-1980 Dolo - a/a to tan, brn; abun Anhy
 1980-2000 SS - wh, mg, dolote, hd & tite, NS; Dolo - a/a to wh, pnk;
 abun Anhy
 2000-2020 Dolo & Anhy a/a

FOURTH CONVERSE SANDSTONE 2020

2020-2030 SS - clr, mg, fri, porous, NS; Dolo & Anhy a/a
 Circ 2035 SS - wh, mg, fri, porous, abun free Sd, NS; Sh, Dolo &
 Anhy a/a
 2035-2040 Same a/a
 2040-2060 Anhy - wh to brn, dns to xln; little Dolo - tan, pnk;
 diminishing SS a/a
 2060-2070 Same a/a w/abun free Sd - mcg, NS
 2070-2100 Dolo - tan, pnk, viol, dns, gran; little Anhy, Sh & SS a/a
 2100-2110 Anhy - wh, dns, xln; Dolo - tan, pnk; abun Sh - red
 2110-2120 Dolo - wh mottled viol, dns; little Anhy & Sh a/a
 2120-2130 Same a/a w/free Sd
 2130-2160 Same as 2110-20 w/little SS - wh to lvndr, fg, poor porosity,
 NS



ConRoy #1 F. A. Peterson
C NE SE 22 T7S R1E
Fall River Co., South Dakota

GEOLOGIC RECORD (Cont'd.)

RED MARKER 2160

- 2160-2170 Same a/a w/little "Red Marker" Sh - red, lvndr, splntry, sub-metallic, specular sheen
- 2170-2180 Abun "Red Marker" Sh w/Dolo, Anhy & SS a/a
- 2180-2190 Dolo - wh, tan, gran to dns; abun Anhy; little "Red Marker" Shale
- 2190-2200 Little SS - wh mottled viol, mg, tite, NS; Dolo, Anhy & abun "Red Marker" Sh
- 2200-2210 Sh - dead blk, v/hd & brtl, fisl; Same a/a
- 2210-2220 Same a/a w/Dolo - lt to drk gry, gran to earthy
- 2220-2260 Dolo - tan, brn, wh, pnk; little Anhy; little SS - wh, fmg, tite, NS; Sh a/a
- 2260-2270 SS - gry, fcg, dolotc, tite, NS; Dolo, Anhy & Sh a/a

Begin 5' Samples

- 2270-2275 Dolo - gry to drk brn, microxln; SS - a/a, NS
- 2275-2285 Dolo - a/a; little Anhy - wh
- 2285-2290 Sh - blk, brittle, flakey; tr SS - gry, fmg, dolotc, tite, NS

SECOND LEO SANDSTONE 2290

- 2290-2300 SS - gry, fmg, v/dolotc grading to sdy dolo, tite, NS; little Anhy - wh, xln
- 2300-2311 Dolo - med gry, fn xln
- Circ 2314 Sh - blk, silty, brittle
- 2314-2320 Dolo - med gry, microxln, prtly w/setrd sd grns
- 2320-2325 SS - gry to wh, fmg, v/dolotc, tite, NS

Resume 10' Samples

- 2325-2335 Dolo - gry to wh, microxln, tite; Anhy - gry, sdy
- 2335-2345 Sh - blk, silty, hd
- 2345-2355 Dolo - gry, microxln, hd
- 2355-2363 Dolo - a/a w/abun Anhy - wh, xln
- Circ 2363 SS - gry, mg, v/dolotc, tite, NS
- 2363-2375 Dolo - med gry, microxln; little Anhy - wh, xln
- 2375-2385 Sh - blk & drk brn, silty, carb
- 2385-2390 Dolo - med gry, microxln; little SS - wh to buff, fmg, dolotc, tite, NS
- 2390-2400 SS - a/a, NS
- 2400 TOTAL DEPTH



ConRoy #1 F. A. Peterson
C NE SE 22 T7S R1E
Fall River Co., South Dakota

DRILLING RECORD

Remarks

The original proposal was to drill a 12-1/4-inch surface hole to a depth of approximately 1050 feet and set surface casing at that point to shut off water flows which were anticipated from the Dakota, Lakota and Sundance Sandstones. From under surface a 7-7/8-inch hole was to be drilled to the total depth of approximately 2600 feet.

In practice, 30 feet of 14-inch conductor pipe was set in 30 feet of 17-1/4-inch hole. 8-3/4-inch pilot hole was drilled 30-645 feet, followed by 7-7/8-inch pilot hole 645-906 feet; reamed 12-1/4 inch from 30-847 feet; 7-7/8-inch pilot hole 906-1140 feet and reamed 12-1/4-inch from 947-1140 feet. 8-5/8-inch surface pipe was set at 1136 feet resulting in a successful water shut-off. The balance of the hole was drilled 7-7/8-inch to the total depth of 2400 feet. Lost circulation was encountered momentarily at 2025 feet, but was cured by the addition of lost circulation material. Because of deviation problems, 5-1/2 days were required to drill and ream the surface hole. Casing was set and the balance of the test was drilled in 8 days.

The test was drilled with a Unit U-34 rig utilizing two 671 GM Diesel draw works motors (300 HP) and a 214P Oil Well 7-1/4" x 14" mud pump with two 6-110 GM Diesel motors (600 HP).

Well History

12-10-65	Rig up; drill 30' of 17-1/4" conductor hole and set 30' of 14" conductor pipe
12-11-65	Drill 8-3/4" surface hole 30-663'
12-12-65	Drill 8-3/4" surface hole 633-645'; drill 7-7/8" surface hole 645-852'
12-13-65	Drill 7-7/8" surface hole 852-906'; ream surface hole 30-565' to 12-1/4"
12-14-65	Ream surface hole 565-847' to 12-1/4"
12-15-65	Drill 7-7/8" surface hole 906-1140'; ream 847-947' to 12-1/4"
12-16-65	Ream surface hole 947-1140 to 12-1/4"; set surface casing; W.O.C.
12-17-65	W.O.C.; drill cement 1093-1140; drill 7-7/8" hole 1140-1340'
12-18-65	Drill 7-7/8" hole 1340-1656'
12-19-65	Drill 7-7/8" hole 1656-1919'
12-20-65	Drill 7-7/8" hole 1919-2046'
12-21-65	Drill 7-7/8" hole 2046-2198'
12-22-65	Drill 7-7/8" hole 2198-2301'
12-23-65	Drill 7-7/8" hole 2301-2400' total depth; prepare to log
12-24-65	Run logs; plug and abandon

DRILLING RECORD (Cont'd.)

Bit Record

<u>Bit #</u>	<u>Size</u>	<u>Make</u>	<u>Type</u>	<u>In</u>	<u>Out</u>	<u>Footage</u>
1	8-3/4	HTCo	OSC3	30	646	Dr 616'/12 hrs.
2	7-7/8	HTCo	OSC3	646	845	Dr 199'/16 hrs.
3	7-7/8	HTCo	OWC	845	906	Dr 61'/7 hrs.
4	7-7/8	HTCo	LW3	906	1120	Dr 214'/16 hrs.
5	7-7/8	HTCo	LW3	1120	1140	Dr 20'/2 hrs.
6	12-1/4	Smith	DT	29	667	Rm 638'/16 hrs.
7	12-1/4	Smith	DT	667	847	Rm 180'/7 hrs.
8	12-1/4	HTCo	OSC3	847	1140	Rm 293'/8 hrs.
9	7-7/8	Smith	K2PJ	1140	1462	Dr 322'/12 hrs.
10	7-7/8	Reed	YS1R	1462	1656	Dr 194'/8 hrs.
11	7-7/8	Smith	K2PJ	1656	1854	Dr 198'/12 hrs.
12	7-7/8	HTCo	OWVJ	1854	1948	Dr 94'/10 hrs.
13	7-7/8	Smith	T2J	1948	2046	Dr 98'/12 hrs.
14	7-7/8	Reed	YMR	2046	2153	Dr 107'/13 hrs.
15	7-7/8	Reed	YHGJ	2153	2228	Dr 75'/12 hrs.
16	7-7/8	HTCo	OWV	2228	2273	Dr 45'/8 hrs.
17	7-7/8	Smith	4W4	2273	2321	Dr 48'/9 hrs.
18	7-7/8	HTCo	OWC	2321	2400	Dr 79'/10 hrs.

Casing Record

30' of 14" spiral weld conductor pipe at 30' w/10 sx
 1125.36' of 8-5/8" surface casing at 1136.36 KB w/850 sx

Mud Program

The surface hole (30-1140') was drilled with weighted mud in anticipation of water flows from the Dakota, Lakota and Sundance Sandstones. The mud was maintained at an average weight of 11 lb/gal and an average viscosity of 50 sec/qt.

After surface casing, the balance of the hole was drilled with mud having the following average characteristics:

Weight	10.4 lb/gal
Viscosity	38 sec/qt
Water Loss	13 cc. API

A momentary loss of circulation occurred at 2025' in the 4th Converse Sandstone. The condition was remedied with very little loss of mud by the addition of lost circulation material. No further trouble was encountered.



DRILLING RECORD (Cont'd.)

Plugging Record

Used 50 sacks of cement to plug as follows:

1925-1850 w/25 sacks
1195-1120 w/25 sacks

In lieu of a surface plug, a cap was screwed and tack-welded to the surface casing to permit later re-entry for conversion to a water well.

PENETRATION RATE

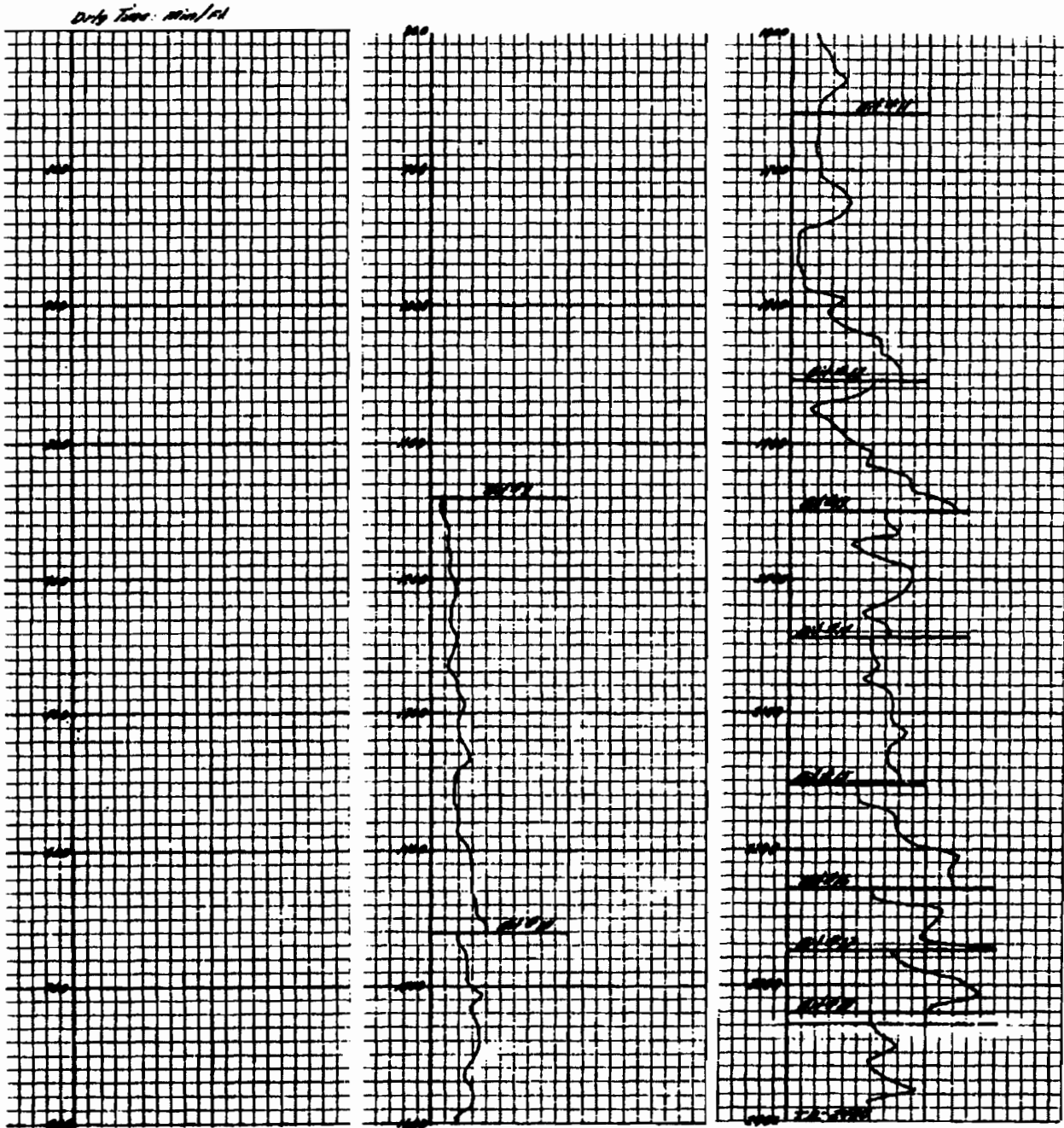



ADMINISTRATIVE / SUNDRY REPORTS

STATE OF S.D. - PIERRE

PLUGGING RECORD

Operator THE CONSOLIDATED ROYALTY OIL COMPANY		Address P. O. Box 605, Casper, Wyoming 82601	
Name of Lease F. A. Peterson	Well No. 1	Field & Reservoir Wildcat	
Location of Well 1980' FEL and 1980' FSL of Section 22-7S-1E		Sec-Twp-Rge or Block & Survey	County Fall River
Application to drill this well was filed in name of THE CONSOLIDATED ROYALTY OIL COMPANY	Has this well ever produced oil or gas No	Character of well at completion (Initial production): Oil (bbbls./day) -- Gas (MCF/day) -- Dry? Yes	
Date plugged: 12-24-65	Total depth 2400'	Amount well producing when plugged: Oil (bbbls./day) -- Gas (MCF/day) -- Water (bbbls./day) --	
Name of each formation containing oil or gas. Indicate which formation open to well-bore at time of plugging No oil or gas. Refer to well summary and sample description for details	Fluid content of each formation	Depth interval of each formation	Size, kind & depth of plugs used indicate zones squeeze cemented, giving amount cement 1925' to 1850' - 25 sx; 1195' to 1125' - 25 sx.

CASING RECORD

Size pipe	Not in well (ft.)	Polled out (ft.)	Left in well (ft.)	Give depth and method of parting casing (shot, ripped, etc.)	Packers and Seals
8-5/8"	1125.36'		All		Guide shoe, float collar and six centralizers

Was well filled with mud-laden fluid, according to regulations? **Yes** Indicate deepest formation containing fresh water **Basal Sundance from 1102'-1120'**

In addition to other information required on this form, if this well was plugged back for use as a fresh water well, give all pertinent details of plugging operations to base of fresh water sand, perforated interval to fresh water sand, name and address of surface owner, and attaching letter from surface owner authorizing completion of this well as a water well and agreeing to assume full liability for any subsequent plugging which might be required.

With the verbal approval of Mr. Earl Cox, State Engineer, the cement plugs normally set in the bottom and top of the surface casing were omitted to allow the surface owner, Mr. Francis A. Peterson, P.O.Box 5, Burdock, South Dakota to convert the cased surface hole into a water well pending approval of Oil and Gas Board and Water Resources Commission. The water producing sands of the Dakota-Lakota series, Sundance and Basal Sundance formations were successfully cased off with 8-5/8" 24 lb. casing set in the Spearfish @ 1128' ground level. The surface casing string was cemented to surface with 850 sacks of cement with good returns of cement slurry (estimate 50 bbbls.) flowing to reserve pit during displacement. No additional water zones were encountered while drilling below the surface casing to total depth. A casing protector with the abandonment marker welded on top has been screwed into the top casing collar at ground level and tack welded to permit later re-entry for conversion to a water well.

USE REVERSE SIDE FOR ADDITIONAL DETAIL

Executed this the **13th** day of **January**, 19**66**
 State of **WYOMING**
 County of **NATRONA**
 Signature of Affiant: *Edward F. Rorke*

Before me, the undersigned authority, on this day personally appeared **Edward F. Rorke** known to me to be the person whose name is subscribed to the above instrument, who being by me duly sworn on oath states, that he is duly authorized to make the above report and that he has knowledge of the facts stated therein, and that said report is true and correct.

Subscribed and sworn to before me this **13th** day of **January**, 19**66**
 SEAL
 My commission expires **May 13, 1967**
 Notary Public in and for **NATRONA**
 County, **WYOMING**

DO NOT WRITE BELOW THIS LINE
 Approved: *6-14-66* Date
 OIL AND GAS BOARD OF THE STATE OF SOUTH DAKOTA
 Secretary: *William A. Johnson*

June 13, 1966
William A. Johnson
 SECRETARY

Note: File 2 copies of this form with Secretary, Oil & Gas Board, Pierre.

S. Dak. Oil & Gas Board
FORM 4

STATE FEE \$1.00 PER LINE

**WELL COMPLETION OR RECOMPLETION
REPORT AND LOG**

FARM OR LEASE NAME

F. A. Peterson

WELL NO.

1

FIELD AND POOL OR WILDCAT

Wildcat

NO. ACRES IN LEASE

1840 acres

T. 11 SEC. TWP. RGE.

C W&SB; Sec. 22-7E-1E

COUNTY

Fall River

TYPE OF COMPLETION

Oil Well Gas Well **DRY AND ABANDONED**
 New Well Work-Over Deepen Plug Back Same Zone Diff Zone

OPERATOR

THE CONSOLIDATED ROYALTY OIL COMPANY

ADDRESS

P. O. Box 605, Casper, Wyoming 82401

LOCATION (In feet from nearest lines of section or legal subdivision where possible)*

Surface

1980' FSL and 1980' FSL of Section 22-7E-1E, NW
Top prod. interval

At total depth

PERMIT NO.

408

DATE ISSUED

11-23-65

PREVIOUS PERMIT NO.

DATE ISSUED

DATE SPUDDED

12-11-65

DATE T. D. REACHED

12-23-65

DATE COMPL. (Ready to Prod.)

-- --

ELEVATIONS (DE, HKB, BT, GR, etc.)*

3522' DE Or - 3535' HKB

FLY - CASING HEAD

FLY - CASING HEAD

TOTAL DEPTH (CMD & TVD)

2400'

PLUG BACK (T. D. CMD & TVD)

-- --

IF MULTIPLE COMPL. HOW MANY*

-- --

INTERVALS DRILLED BY

0' to 2400'

ROTARY TOOLS

None

CABLE TOOLS

None

PRODUCING INTERVAL(S), THIS COMPLETION, TOP, BOTTOM, NAME (CMD & TVD)*

None

DATE DIRECTIONAL SURVEY SUBMITTED

None

TYPE ELECTRIC AND OTHER LOGS RUN (Circle those filed)

Sonic Log-Gamma Ray with Caliper, Dual Induction-Laterolog

WAS WELL CORKED

No

CASING RECORD (Report all strings set in well)

CASING SIZE	DEPTH SET (CMD)	HOLE SIZE	WEIGHT LBS. FT.	PURPOSE	SACKS CEMENT	AMOUNT PULLED
8-5/8"	1135'	12-1/4"	24 lb.	Surface csg.	850	None

LINER RECORD

SIZE	TOP (CMD)	BOTTOM (CMD)	SACKS CEMENT	SCREEN (CMD)	SIZE	DEPTH SET (CMD)	PACKER SET (CMD)

TUBING RECORD

DEPTH INTERVAL (CMD)	HOLES PER FT.	SIZE AND TYPE	PURPOSE	ACID, SHOT, FRAC., CEMENT SQUEEZE, Etc.	AMOUNT AND KIND OF MATERIAL USED	DEPTH INTERVAL (CMD)

PRODUCTION

DATE FIRST PRODUCTION: PRODUCING METHOD (Flowing, gas lift, pumping, size & type of pump) WELL STATUS (Prod. or Shut in)

DATE OF TEST: HOURS TESTED: CHOKED SIZE: PRODUCTION (24-HOUR TEST) OIL, bbls. GAS, Mcf. WATER, bbls. & % OIL GRAVITY (API) (Corr.)

FLOW TUBING PRESSURE: CASING PRESSURE: CALCULATED 24-HOUR RATE OIL, bbls. GAS, Mcf. WATER, bbls. & % GAS-OIL RATIO

DISPOSITION OF GAS (sold, used for fuel, vented, etc.)

TEST WITNESSED BY

LIST OF ATTACHMENTS

2 copies Well History **2 prints Sonic Log-Gamma Ray with Caliper** **2 prints Dual Induction-Laterolog**

I hereby certify that the foregoing and attached information is complete and correct as determined from all available records

SIGNED: *Edward F. Korte* TITLE: **Production Superintendent** DATE: **1-13-66**

DO NOT WRITE BELOW THIS LINE

*See Instructions On Reverse Side

Approved

Date

1-14-66

OIL AND GAS BOARD OF THE STATE OF SOUTH DAKOTA

Charles Larson Secretary



CORRESPONDENCE



March 9, 1966

Mr. Earl J. Cox
South Dakota Geological Survey
Box 187
Belle Fourche, South Dakota

Dear Earl:

Reference is made to your letter of March 7, 1966, addressed to Mr. Bill Lewis, Bueno Drilling Company, concerning the Bueno #1 Holloway-State Well.

In the fifth paragraph, you stated that you assumed the various required reports had been sent to our office. We have received everything except two copies of the dual-induction laterolog, and two copies of the sonic gamma-ray log.

Sincerely,

Merlin J. Tipton
Assistant State Geologist

MJT:bm

P. S. We received the samples from the following wells today.

Consolidated Royalty #1 Peterson
NW SE 22-78-1E
Fall River County

Consolidated Royalty #1 Childers
9-88-2E
Fall River County

Consolidated Royalty #1 Superior-USA
10-98-2E
Fall River,

January 31, 1966

Mr. Earl J. Cox
State Geological Survey
P. O. Box 187
Belle Fourche, S. Dak.

Dear Earl:

I am enclosing a dual induction-laterolog sonic log - gamma ray for each of the following wells:

Conroy #1 U.S.A. Superior
Fall River County

Conroy #1 Childers
Fall River County

Conroy #1 Peterson
Fall River County

Tenneco #1 USA-Ideen
Fall River County

Sincerely,



(Mrs.) Ruth Lynch
Bookkeeper

For the State Geologist

Inclosures 6



January 10, 1966

Re: Conroy #1 Peterson
Fall River County

Mr. Earl J. Cox
State Geological Survey
Box 187
Belle Fourche, South Dakota

Dear Earl:

I think you are quite right that we do not need to involve Joe Grimes in taking over this particular well at this time. I think that it is advisable for us to keep close check with Mr. Peterson to see that he does fulfill the requirements of getting a permit to convert the well to water and to make sure that Joe is involved when such a conversion does take place.

As long as the marker has been placed and the mud pits filled and with Mr. Peterson's release I think we can say that all things have been fulfilled in qualifying this well for release as soon as we have received the information as stated in your letter.

I am being flooded with letters giving viewpoints about our changes in Rules and Regulations. At this time it appears that Gulf is definitely in the minority in their thinking and certainly the more letters that I can get to validate a particular position, that will be the direction in which I have to advise the board. When the time does come that a decision needs to be made, I want to sit down with you and go over all the correspondence to arrive at an adequate recommendation to give to the board for any rule changes. Possibly this could be done in Pierre sometime.

Earl, I want to express my sincere and deepest appreciation, as I have done to the personnel here, on your kindness in giving me the bowling ball this past Christmas. It does my heart a lot of good to know that the employees are behind the activities of the Survey 100% and you can be sure that I am going to do my utmost to see that the people in the Survey are given every benefit possible from the standpoint of improving the situation both in work and time.

**Mr. Earl J. Cox****Page 2****January 10, 1966**

I have to go to Pierre this Wednesday to appear before the appropriations committee. The Governor does want to give us money for another ground water geologist. Although I did not ask for this money, the pressure outside has caused the administration to see fit to bend to this request and therefore asked me to give them a modest sum for inclusion in our budget to enhance our ground-water program. The sum that I asked for was \$18,650.00 to be divided between salary O & M and direct match moneys for the USGS.

I feel somewhat remiss in the fact that E. Y. Berry responded to your letter about those plates to this office. I mislaid the correspondence and have just now found it. When you hear from Billings, I think it would be nice to write E. Y. Berry and inform him as to whether or not you achieved this material. His letter is enclosed.

Sincerely,

**Duncan J. McGregor
State Geologist**

DJM:bm

Enc.



SCIENCE CENTER, UNIVERSITY OF SOUTH DAKOTA CAMPUS, ^{37 of 48}
VERMILLION, 57089, PHONE 624-4471

WESTERN FIELD OFFICE, 208 GAY BUILDING, BELLE FOURCHE,
BOX 187, 57717, PHONE 892-3121



Western Field Office
January 6, 1966

Dr. Duncan McGregor
State Geologist
State Geological Survey
Vermillion, South Dakota

Re: Conroy #1 Peterson
NWSE-22-75-1E
Fall River County, So. Dakota
Permit No. 408

Dear Duncan:

Enclosed is an original and copy of a letter from the landowner of the above test that is self-explanatory. Peterson's letter is addressed to you, rather than Joe Grimes, as the test may not be converted for a long time and it would seem pointless to have the Water Resources Commission assume jurisdiction of the well at this time. However, we can go through the procedure of turning it over to the Water Resources Commission if you feel this is the proper action to take.

The marker has been placed and the pits filled and smoothed. The location can be released from bond coverage after we have received the following:

One set of samples
Two copies of the dual induction log
Two copies of the sonic-gamma ray log
Two copies of the sample description
Final plugging forms.

Sincerely,

Earl Cox
Engineering-Petroleum Geologist

EC:sn

DUNCAN J. MCGREGOR
DIRECTOR AND STATE GEOLOGIST
VERMILLION

MERLIN J. TIPTON
ASSISTANT STATE GEOLOGIST
VERMILLION

EARL J. COX
SENIOR GEOLOGIST
BELLE FOURCHE

Burdock, South Dakota
December 28, 1965

JAN -7 1966

Dr. Duncan McGregor
State Geologist
State Geological Survey
Vermillion, South Dakota

Re: Conroy #1 Peterson
NWSE-22-3S-1E
Fall River County, So. Dakota
Permit No. 408

Dear Dr. McGregor:

At my request, the ten sack surface plug was eliminated in plugging the above test. It is planned that some time in the future, the surface casing in the hole will be perforated and the test made into an artesian water well.

Should the test be converted to a water well, in the future, I agree to assume full liability for any subsequent plugging that might be required.

Sincerely,

Francis A. Peterson

Burdock, South Dakota
December 28, 1965

Jan 7 1966

Dr. Duncan McGregor
State Geologist
State Geological Survey
Vermillion, South Dakota

Re: Conroy #1 Peterson
NWSE-22-7S-1E
Fall River County, So. Dakota
Permit No. 408

Dear Dr. McGregor:

At my request, the ten sack surface plug was eliminated in plugging the above test. It is planned that some time in the future, the surface casing in the hole will be perforated and the test made into an artesian water well.

Should the test be converted to a water well, in the future, I agree to assume full liability for any subsequent plugging that might be required.

Sincerely,

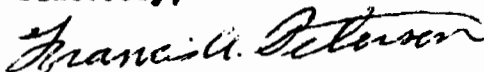

Francis A. Peterson



Western Field Office
December 27, 1965

Mr. Francis A. Peterson
P. O. Box 5
Burdock, South Dakota

Re: Conroy #1 Peterson
NWSE-22-7S-1E
Fall River County, So. Dakota
Permit No. 408

Dear Mr. Peterson:

Following your request, the test sock surface plug was not placed when the above test was plugged. To leave out this plug, it is necessary that you request it in writing.

Enclosed is an original and two copies of a letter to the State Geologist, requesting that the surface plug not be required. Please sign the original and two copies and return them to me in the enclosed addressed envelope.

Sincerely,

Earl Cox
Engineering-Petroleum Geologist

EC:sn

SOUTH DAKOTA
State Water Resources Commission

STATE OFFICE BUILDING
PIERRE, SOUTH DAKOTA

November 24, 1965

Francis A. Peterson
P. O. Box 5
Burdock, South Dakota

I have been advised that the **Consolidated Royalty Oil Co.** has obtained a Permit to Drill for Oil and Gas on your land in Section 22, T 7 S, R 1 E.

Occasionally, owners of land consider converting abandoned oil wells into water wells. Please advise me whether or not you intend to convert the oil well drill hole on your land into a water well if water is encountered and the drill hole is abandoned as an oil well.

If you are considering making a water well out of the abandoned oil well drill hole, special considerations are necessary to comply with the State's oil and water laws. The abandoned oil hole must be properly plugged and the water well properly constructed. All conversion work will be at your expense. The cost will vary, depending upon the characteristics of the drill hole, but such cost will be in the neighborhood of \$5,000 or more. Usually another driller and drill rig will have to be arranged for. This other drill rig and casing and other materials will have to be on hand to take over immediately after the special oil well plugging is completed, because the drill hole cannot be left open for any appreciable length of time without spoiling it. Approval of plans for construction of the water well will be required, and a bond covering proper construction may be required. Also, a water right may be required. All of these arrangements take considerable time to accomplish.

Please advise me immediately if you plan to convert the oil well drill hole into a water well. We both hope that a producing oil well results from the drill hole on your land; however, if not and you are planning on a water well, we must start making arrangements now.

Sincerely,

J.W. GRIMES
Chief Engineer

JWG/bw
cc Oil & Gas Board, Pierre, South Dakota
Dr. Duncan McGregor, State Geologist, Vermillion, S.D.



POWERTECH (USA) INC.



S. NCE CENTER, UNIVERSITY (SOUTH DAKOTA CAMPUS,
VERMILLION, S7068, PHONE 684-4471

WESTERN FIELD OFFICE, 208 GAY BUILDING, BELLE FOURCHE,
BOX 187, S7717, PHONE 682-3121

NOV 5 1965

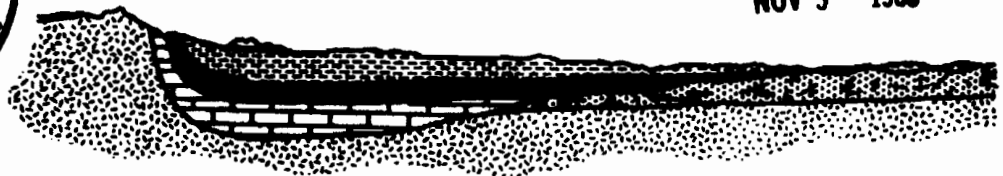

Western Field Office
November 4, 1965

Dr. Duncan McGregor
State Geologist
State Geological Survey
Vermillion, South Dakota

Dear Duncan:

Just a note to let you know that Consolidated Royalty Oil
Company will make application for permits on the following locations:

Conroy #1 Childers
NESE-9-85-2E
Fall River County

Conroy #1 Peterson
NWSE-22-75-1E
Fall River County

Conroy #1 Superior-USA
SESE-10-95-2E
Fall River County

The first well will test the basal Sundance formation. The
other two will test the second Lee Sand.

Consolidated Royalty is in the process of obtaining a \$20,000
blanket bond. This would indicate that further tests are planned.

Sincerely,

Earl Cox
Engineering-Petroleum Geologist

EC:sa

DUNCAN J. MCGREGOR
DIRECTOR AND STATE GEOLOGIST
VERMILLION

HERLIN J. TIPTON
ASSISTANT STATE GEOLOGIST
VERMILLION

EARL J. COX
SENIOR GEOLOGIST
BELLE FOURCHE

SURETY

NO SURETY INFORMATION FOR THIS WELL AS OF 5/18/2011

MISCELLANEOUS



Rec'd 3-6-66

INVOICE

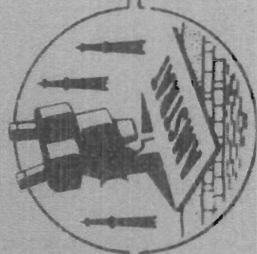

AMERICAN STRATIGRAPHIC COMPANY

1820 BROADWAY, DENVER · 524 E. YELLOWSTONE, CASPER · 17 NO. 31ST ST. BILLINGS

March 2, 1966

NC 1825

South Dakota Geological Survey
Attn: Dr. Duncan McGregor
Science Center
Vermillion, South Dakota

P. O. NO.

SOUTH DAKOTA SAMPLE CUTS

Consolidated Royalty #1 Peterson
NW SE 22-7S-1E
Fall River County, South Dakota

Consolidated Royalty #1 Childers
9-8S-2E
Fall River County, South Dakota

Consolidated Royalty #1 Superior - USA
10-9S-2E
Fall River County, South Dakota

N/C



Oil and Gas Search for: api_no_ like '40 047 20071'		
Page 1 of 1	<input type="button" value="Export Options"/> (temporarily unavailable)	Page: 1

Record 1 of 1

Well Information

API No:	40 047 20071	County:	FALL RIVER
Well Name:	ARC 34-11 PETERSON	Location:	SWSE 11-7S-1E
Permit No:	776	Total Depth:	2250
Operator Name:	AQUARIUS RESOURCES CORPORATION	Bottom Hole:	Minnelusa
Permit Date:	11-10-1976	KB Elevation:	3689
Spud Date:	12-09-1976	Ground Elevation:	3679
Plug Date:	12-22-1976	Latitude:	43.451453
		Longitude:	-103.963826
Well Field	WILDCAT	Status	P&A
Class:	DRY HOLE	Type:	DRY HOLE

Formation Tops

<u>Formation</u>	<u>Depth (ft.)</u>
Morrison	406
Sundance	570
Spearfish	866
Goose Egg	1158
Minnekahta	1412
Opeche	1452
Converse	1552
Red Marker	1952
1st Leo	1964
2nd Leo	2062
3rd Leo	2168

Page 1 of 1 (goto top)	Page: 1 Prev Next
---	---

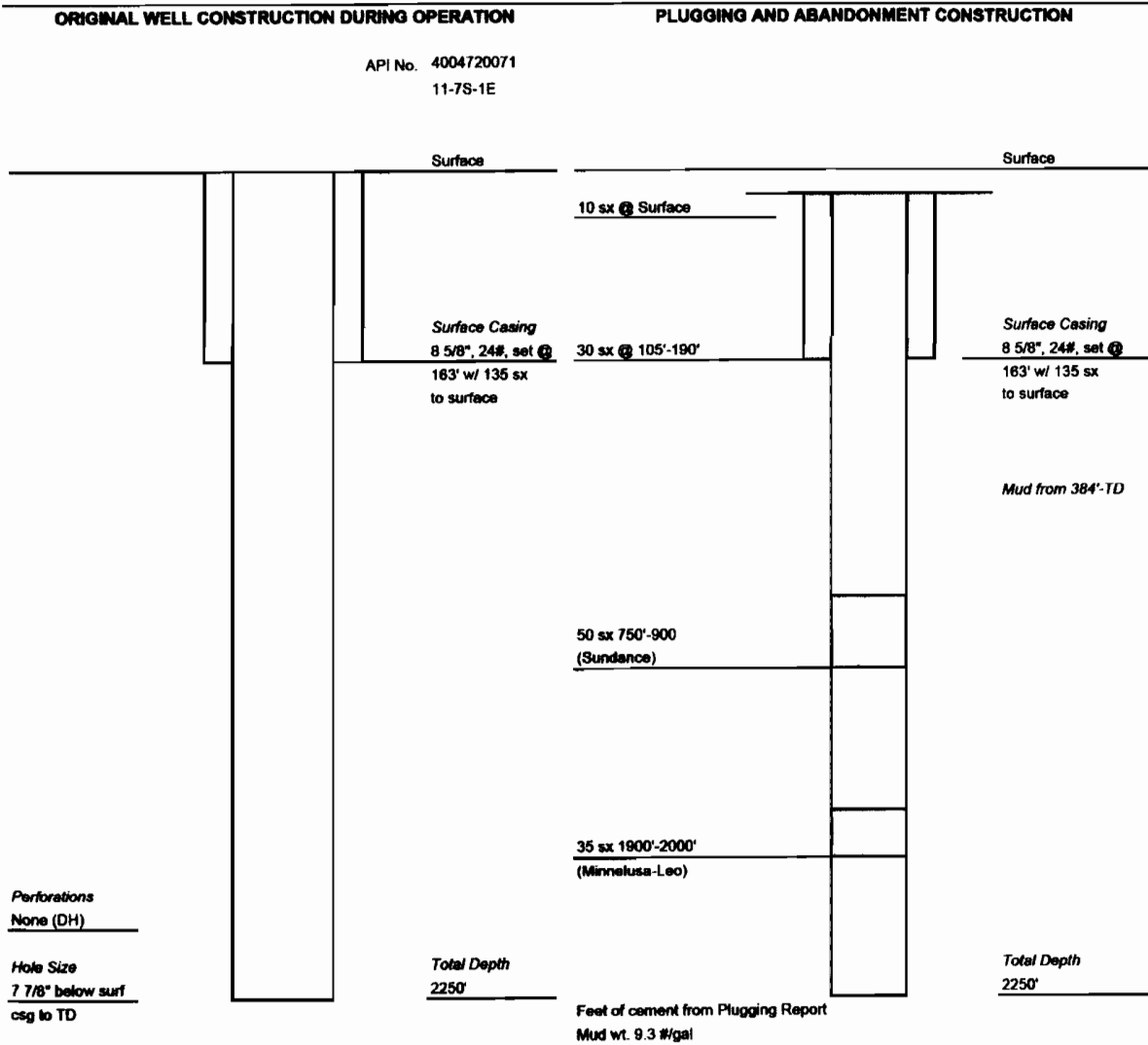

UNIFORM NO. 10-1-1966

SUNDRY NOTICES AND REPORT ON WELLS		FARM OR LEASE NAME Peterson
		WELL NO. 34-11
<input type="checkbox"/> OIL WELL <input type="checkbox"/> GAS WELL <input type="checkbox"/> ----- <input checked="" type="checkbox"/> DRY		FIELD AND POOL, OR WILDCAT Wildcat
OPERATOR AQUARIUS RESOURCES CORPORATION		NO. ACRES IN LEASE 1080.00
ADDRESS 307 Conroy Building, Casper, Wyoming 82601		T & SEC. TWP. RGE. SW SE 11-7S-1E
LOCATION (1/4 sec from nearest 1/4 sec of corner of 1/4 sec township, where possible) 660' FSL, 2217' FEL Section 11-7S-1E		COUNTY Fall River
ELEVATIONS (D.P., R.C.B., R.T., O.R.D., etc.: how determined) 3679' Gr., 3689' K.B.		

INDICATE BELOW BY CHECK MARK NATURE OF REPORT, NOTICE OR OTHER DATA

NOTICE OF INTENTION TO:		SUBSEQUENT REPORT OF:	
TEST WATER SHUT-OFF	<input type="checkbox"/>	SHOOT OR ACIDIZE	<input type="checkbox"/>
FRACTURE TREAT	<input type="checkbox"/>	REPAIR WELL	<input type="checkbox"/>
MULTIPLE COMPLETS	<input type="checkbox"/>	PULL OR ALTER CASING	<input type="checkbox"/>
ABANDON	<input checked="" type="checkbox"/>		

(Note: Report results of multiple completion on Well Completion or Recombination and Log Form - Form 4)

DESCRIBE PROPOSED OR COMPLETED OPERATIONS (Clearly state all pertinent details, and give pertinent dates, including estimated date of starting any proposed work)

Water was encountered in all porous zones drilled. The Leo sand had excellent porosity but yielded sulphur water when tested. Proposed plugging as approved by telephone is as follows:

- 35 sx 1900-2000 Minnelusa-Leo
- 50 sx 750- 900 Sundance
- 30 sx 105- 190 base of surface casing
- 10 sx Surface plug & erect dry hole marker

I hereby certify that the foregoing as to any work or operation performed is a true and correct report of such work or operation.
 SIGNED John F. Keller TITLE President DATE December 23, 1976

Approved Jan. 4, 1977 Date
 DO NOT WRITE BELOW THIS LINE
 OIL AND GAS BOARD OF THE STATE OF SOUTH DAKOTA
Fred V. Steen
 CONDITIONS, IF ANY: _____ SUPERVISOR
 See Instructions On Reverse Side





Synopsis

Operator: Aquarius - Double U - Powerco

Well: #34-11 Peterson

Location: C/SW SE; 660' FSL, 2217' FEL
Section 11, T. 7S., R. 1E.
Fall River County, South Dakota

Area: Wildcat (Driftwood Canyon Prospect)

Elevation: 3679' Ground, 3689' K.B.

Spudded: December 9, 1976 (7:30 A.M.)

Ceased Drilling: December 22, 1976 (3:30 A.M.)

Completed: December 23, 1976 (12:30 A.M.)

Status: P & A

Total Depth: 2250' driller, 2248' log

Casing: 8-5/8" surface casing set @ 163'

Hole Size: 7-7/8" below surface to TD

Contractor: A. O. Bullock Drilling Co. - Rig #1
Tool Pusher - Ray Gottrell
Drillers - Larry Halligan, D. F. Ellsworth, Chuck Sides

Drilling Mud: Wyoming Mud Co., Casper, Wyo.
Gel-Chemical from 384' to TD
Engineer - Bruce Johnson

Lost Circulation: Lost Circulation for 5 1/2 hours @ 384'.

Coring: No cores cut.

Drill Stem Tests: Halliburton Services
DST #1; 2nd Leg, 2060'-2082' (adjusted to log from 2068'-2090')
Rec. 125' muddy water, 1838' black sulfur water.
Engineer - D. R. Rook, Gillette, Wyoming

Logs: Schlumberger Well Surveying Corp.
Ran Dual Induction-Late-log from 2248' to base of surface casing.
Ran Borehole Compensated Sonic Log w/caliper from 2248' to base of surface casing. Ran Gamma Ray log from base of surface casing to surface.
Engineer - Craig Rang, Gillette, Wyo.

Samples: All samples were delivered to American Stratigraphic Co., Casper, Wyo., for shipment to their Billings, Montana office where a cut will be made for the South Dakota State Geologist.

COUNTY: FALL RIVER
LEGAL LOCATION: SWSE 11-7S-1E
API NO: 40 047 20071
PERMIT NO: 776
WELL NAME: ARC #34-11 PETERSON
OPERATOR: AQUARIUS RESOURCES
CORPORATION
PERMIT ISSUED: 11/10/1976
PERMIT CLOSED: 01/05/1977
FILE LOCATION: 7S-1E-11 SWSE

TARGET CODES:

WELL HISTORY / CHECKLIST

PERMIT TO DRILL / INTENT TO DRILL

WELL INSPECTION / SCOUT REPORTS

OPERATOR'S TECHNICAL REPORTS / MAPS

ADMINISTRATIVE / SUNDRY REPORTS

CORRESPONDENCE

SURETY

MISCELLANEOUS

WELL HISTORY / CHECKLIST



BCMD RELEASE CHECKLIST

Well Name & Location		Permit # 776
Aquarius #34-11 Peterson SWSE 11-7S-1E - Fall River		API # 40 047 20071
Bond # 19-130-1584-76	Date Issued Sept. 20, 1976	Date Released _____

Surface Restoration

- Pits filled
- Site level
- Site policed
- Dry-hole marker solid, sealed, correctly inscribed
- No dry-hole marker desired, letter in WFO files from surface owner

Paperwork filed

- Form 4 (Completion or Recompletion Report)
- Form 6 (Sundry Notices and Report on Wells)
- Form 7 (Plugging Report) (included on Form #6)

Geological Information Filed

- Well Logs: LES, SNP, DIL, GR, NEUE, CALIP, Cement Bond, Temp, Micro, Laterolog, SM Dens **SONIC**
- DST Charts and Reports
- Geologist's Report
- Results of coring and core analyses (None cut)
- Set of 10-foot sample cuttings (check with Rob Schoon) (samples received @ Vermillion)

DATE 2-5-79 CHECKED BY John Fricke

PERMIT CHECKLIST

Well Name and Location:	Permit # <u>776</u>
Aquarius #34-11 Peterson SWSE 11-7S-1E - Fall River	API # <u>40 047 20071</u>
	Bond # <u>19-0130-1584-76</u>

Paperwork filed with WFO

- Organization Report
- Application
- Bond
- Permit Fee

The Following Papers sent to Operator:

- Permit (Form 2a)
- Receipt for \$100 permit fee
- Cover letter explaining material sent

Permit Fee Filed:

- Permit fee w/Cash Receipts Transmittal Form sent to State Treasurer

Notification of New Permit sent to:

- Dr. Duncan J. McGregor
- Mr. Vern W. Butler
- Dr. Allyn Lockner
- Mr. George Kane

DATE November 11, 1976 CHECKED BY Jean Miller, Secretary, WFO

PERMIT TO DRILL / INTENT TO DRILL

State Pub. Co., Pierre

APPLICATION FOR PERMIT TO:

S. Dak. Oil & Gas Board
FORM 2

<input checked="" type="checkbox"/> DRILL	<input type="checkbox"/> DEEPEN	<input type="checkbox"/> PLUG BACK	FARM OR LEASE NAME
<input checked="" type="checkbox"/> OIL WELL	<input type="checkbox"/> GAS WELL	<input type="checkbox"/> SINGLE ZONE	Peterson
OPERATOR			WELL NO.
AQUARIUS RESOURCES CORPORATION			34-11
ADDRESS			FIELD AND POOL OR WILLCAT
307 Conroy Building, Casper, Wyoming 82601			Wildcat
LOCATION (30 feet from an established corner of the legal subdivision)			NO. ACRES IN LEASE
1/ 660' from South line 2217' from East line Section 11-7S-1E			1080.00
NAME AND ADDRESS OF SURFACE OWNER			SEC. TWP. RCP.
Peterson and Son, Inc. Edgemont, South Dakota 57735			SW SE 11-7S-1E
NAME AND ADDRESS OF CONTRACTOR			COUNTY
A. O. Bullock Drilling Company P. O. Box 821 Casper, Wyoming 82602			Fall River
ELEVATION			NO. OF WELLS ETC.
3679' Gr.			None
PROPOSED DEPTH			ROTARY OR CABLE TOOLS
2300'			Rotary
APPROXIMATE DATE WORK WILL START			November 10, 1976
IF LEASE PURCHASED WITH ANY WELLS DRILLED FROM WHOM PURCHASED (Name and address)			
No			

PROPOSED CASING AND CEMENTING PROGRAM					
SIZE OF HOLE	SIZE OF CASING	VALVE PER FOOT	NEW OR SECOND HAND	DEPTH	SACKS OF CEMENT
1 1/4"	8-5/8"	24#	New	150'	125
7-7/8"	5-1/2"	15.5#	New	2300'	75

DESCRIBE PROPOSED OPERATIONS. IF PROPOSAL IS TO DEEPEN OR PLUG BACK, GIVE DATA ON PRESENT PRODUCTIVE ZONE AND PROPOSED NEW PRODUCTIVE ZONE. GIVE BLOW OUT PREVENTER PROGRAM IF ANY.

Drill a 7-7/8" hole from bottom of surface casing to estimated total depth of 2300 feet. Will test the Leo zones of Minnelusa formation. Drillstem test any zones with shows of oil and gas. If commercial production indicated will set 5 1/2" casing to total depth, perforate and complete.

A double ram, hydraulically operated preventer (Shaffer 10" API Series 900) will be installed and will be tested to a minimum of 500 psi for 15 minutes prior to drilling out from under the surface casing. Deficiencies, if any, will be corrected before drilling ahead. The blowout equipment will be checked daily by opening and closing the pipe rams and blind rams.

SIGNED: John F. Trotter TITLE: President DATE: November 4, 1976

DO NOT WRITE BELOW THIS LINE

APPROVED BY: John F. Trotter TITLE: President DATE: November 10, 1976

CHECKED BY: Fred R. Hecker TITLE: Supervisor DATE: _____

CONDITIONS: COMPLETE SET OF SAMPLES, AND CORES IF TAKEN, MUST BE SUBMITTED. SAMPLES AND CORES IF TAKEN, BELOW DEPTH, MUST BE SUBMITTED.

Exception to statewide spacing pattern allowed for topographic reasons (see Burdock 7 1/2 quad) 4 PWS



INSTRUCTIONS

General: This form is designed for submitting proposals to perform certain well operations, as indicated. All types of lands and leases for oil, gas, or geothermal energy are covered. Federal or State agency, or both, pursuant to applicable Federal and/or State laws and regulations. Consult applicable Federal or State regulations, or appropriate officials, concerning approval of the proposal before operations are started.

If a proposal is to drill to the same reservoir at a different subsurface location or to a new reservoir, use this form with appropriate modifications.

If the well is to be, or has been, directionally drilled, so state and show by attached sheets, if necessary, the coordinates of the hole in any present or objective productive zones.

File 3 copies of this form with Secretary, Oil & Gas Board, Pierre.

(*Sample location: 660' South and 660' East of the Northwest Corner of Section 16.)



R. 1 E

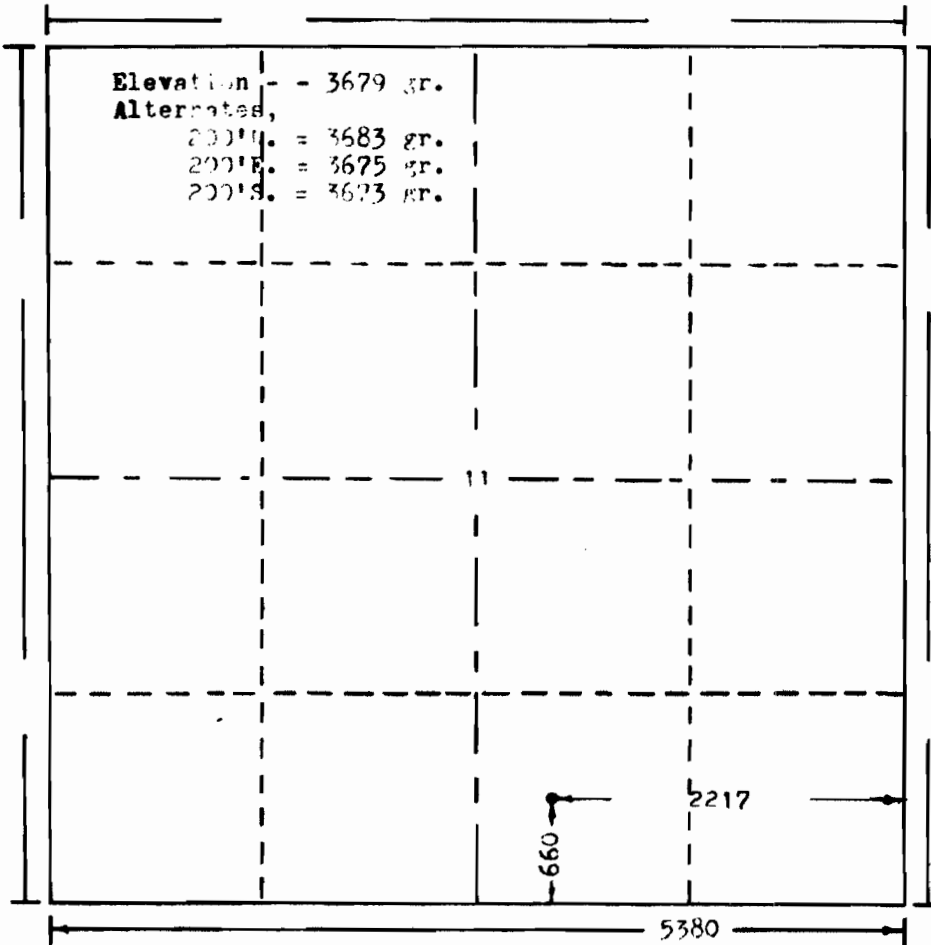

T.
7
S.

Scale... 1" = 1000'

Powers Elevation Company, Inc. of Denver, Colorado
 has in accordance with a request from Mr. Trotter
 for Aquarius Resources Corporation
 determined the location of #34-11 Peterson
 to be 660FS & 2217E Section 11 Township 7 S.
 Range 1 E. of the Black Hills Meridian
 Fall River County, South Dakota

I hereby certify that this plat is an
 accurate representation of a correct
 survey showing the location of
 #34-11 Peterson

Date: 9-22-76

T. Tolson
 Licensed Land Surveyor No.
 State of South Dakota

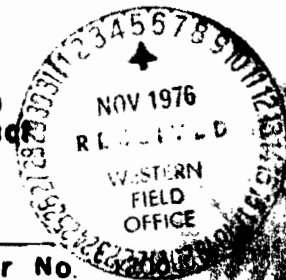



WELL INSPECTION / SCOUT REPORTS



SOUTH DAKOTA GEOLOGICAL SURVEY
Western Field Office

SCOUT REPORT

Number 3

Date Scouted 5/31/78

Operator Aquarius Resources Corporation

Permit Number 776

Farm/Lease Name #34-11 Peterson

API Number 40 047 20071

SWSE Sec. 11 T. 7S R. 1E County Fall River

Elev. 3689 Kb Est. T.D. --- Actual T.D. 2250 Spudded 11-09-76

Contractor --- Geologist Eldred Johnson

SCOUT'S OBSERVATION:

DST RECORD:

Pits filled, landscape recontoured, wild grass and shrubs taking over, no seed planted. Dry hole marker sound, sealed, and properly labeled.

Site Approved.

FORMATION TOPS:

PLUGGING RECORD:

DATE PLUGGED/COMPLETED 12-22-76

CASING RECORD:

8 5/8 From 0 To 163
From --- To ---

SITE INSPECTION:

Approved X
Not Approved ---

REMARKS:

SCOUTED BY John Fricke Fred V. Steece
John Fricke, Geologist
Field Assistant Fred V. Steece, Supervisor
Western Field Office

Aquarius # 34-11 Peterson



SOUTH DAKOTA GEOLOGICAL SURVEY
Western Field Office

SCOUT REPORT

Number 2

Date Scouted 6-15-77

Operator Aquarius Resources Corporation

Permit Number 776

Farm/Lease Name #34-11 Peterson

API Number 40 047 20071

SWSE Sec. 11 T. 7S R. 1E

County Fall River

Elev. 3689 Kb Est. T.D. -

Actual T.D. 2250 Spudded 11-09-76

Contractor A. O. Bullock

Geologist Fred Johnson

SCOUT'S OBSERVATION:

DST RECORD:

The site has not been restored. Mounds of dirt surround a pit that is practically dry. There is no fence and plenty of garbage is laying on the ground. A dry hole marker is in place and is solid, sealed and correctly marked. Near the marker pole is a small open hole and trench that should be filled in. The area has not been leveled or policed and therefore at this time cannot be approved.

FORMATION TOPS:

PLUGGING RECORD:

DATE PLUGGED/COMPLETED 12-22-76

CASING RECORD:

From _____ To _____

From _____ To _____

SITE INSPECTION:

Approved _____

Not Approved X

REMARKS: The site is difficult to locate since the road leading up to the drilling area is for the most part covered with grass and also because the uranium companies have made so many roads in their exploration efforts, which inevitably lead in the wrong direction. (3 pictures).

SCOUTED BY Fred V. Steece
Fred V. Steece, Supervisor

David R. Johnston
David R. Johnston, Geologic Assistant

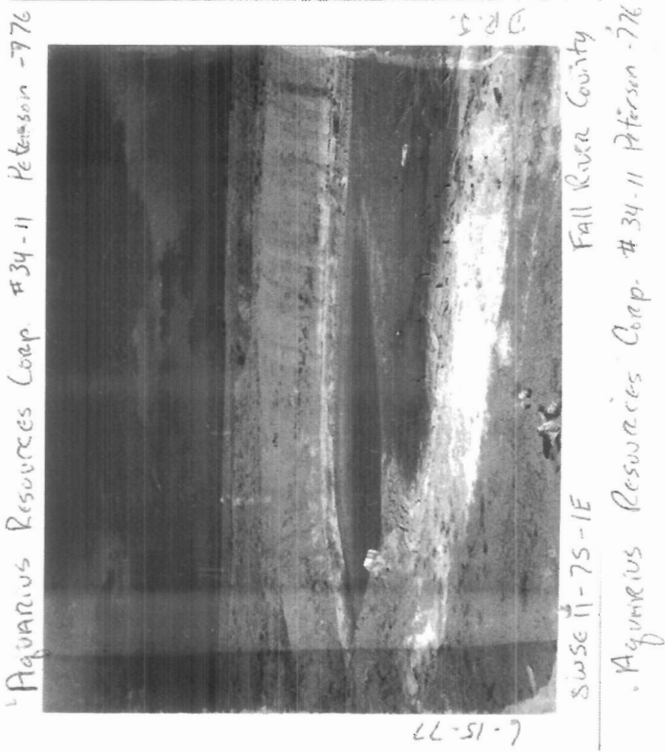



SOUTH DAKOTA GEOLOGICAL SURVEY
Western Field Office

SCOUT REPORT

Number 1

Date Scouted 12-22-76

Operator 1/ Aquarius Resources Corporation

Permit Number 776

Farm/Lease Name #34-11 Peterson

API Number 40 047 20071

SWSE Sec. 11 T. 7S R. 1E

County Fall River

Elev. 3689 Kb Est. T.D. - Actual T.D. 2250 Spudded 11-09-76

1/ Contractor A. O. Bullock

Geologist Eldred Johnson

SCOUT'S OBSERVATION:

Preparing to plug.

DST RECORD:

DST #1: 2068-2090: 2nd Leo
Recovered 1963 water (125 MW, 1838 Blk. sulf. water)
RW = 2.16@ 48°F = 1200 ppm ce.

FORMATION TOPS:

Morrison	406	Opeche	1452	1st Leo	1964
Sundance	570	1st Converse	1552	2nd Leo	2062
Basal sand	819	Conv. Anhyd	1630	3rd Leo	2168
Spearfish	866	2nd Converse	1677		
Gooseegg	1158	3rd Converse	1764		
Minnokahta	1412	Red Marker	1952		

PLUGGING RECORD:

35 sax: 2000-1900 Red Marker
50 sax: 900- 750 Basal Sundance
25 sax: 190- 120 Base Surface
10 sax: Surface plug w/marker

DATE PLUGGED/COMPLETED 12-22-76

CASING RECORD:

8 5/8 From 0 To 163
From _____ To _____

SITE INSPECTION:

Approved _____
Not Approved _____

REMARKS:

(W/135 sax)

SCOUTED BY Fred V. Steece, Supervisor

1/ Casper, Wyoming.



POWERTECH (USA) INC.

API ID 40 047 20071

12 - 40476

✓

Aquarius Res. Corp # Peloton
34-11A
SWSE 11-75-1E Fall River
660 FSL & 2217 FEL

MIRT

Progress Report

PERMIT:	776 (11-10-76)	12-06	MIRT
API:	40 047 20071	12-7	MIRT
ELEV:	3679 Gr., 3689 KB	12-8	RURT
CONTR:	A.O. Bullock (Cooper)	12-9	Spud
GEOL:	Eddred Johnson	12-10	set surface
ENGR:		12-11	386 lost circ.
SPUD:	12-9-76 (7:30 AM)	12-12	486 drlg
EST T.D.:	2300	12-13	688 drlg
CASING:	8 5/8 - 153 @ 164 KB w/175' max	12-14	967 drlg
CORES:	none	12-15	1243 drlg
DST'S:	#1: 2068-2090 m (12' max) Kearney	12-16	1515 drlg
LOGS:		12-17	1663 Drly
T.D.:	2250 over 23		
PLUG:	12-22-76		

✓ Cooper



ABLID 40 047 20071

Foundation Tops (Spl) Foundation Tops: (Eldred Johnson)

Minnokshita	1407	Morrison	406
Opelke	1454	Sundance	570
1 st Converse	1540	(Basal Rd)	819
Converse Anhyd	1636	Spearfish	866
		Horseshoe	1158
	12-22-76	Minnokshita	1412
Call from Eldred Johnson, wanting plugging instr. & outlined the follow-		Opelke	1452
ing:		1 st Converse	1552
		Conr. Anhyd	1630
		2 nd Converse	1677
		3 rd Converse	1764
		Red Marker	1952
35 max: 2000 - 1900	1 st Leo		1964
50 max: 900 - 750	2 nd Leo		2062
25 max: 190 - 120 base surf	3 rd Leo		2168
10 max: Surf plug w/ marker T.D.			2250

DST #1: 2068-2090, 2nd Leo
 Rec 1965 water (125
 MW, 1838 Blk surf (water) Almost flowed, Air in log almost off scale.
 RW = 2.16 @ 48°F = 1200 Cg PPM
 6-15-77
 Site has not been restored. Mounds of dirt surround a pit that is practically dry. No fence, alot of garbage. Dry hole marker solid sealed & correctly marked. Should be leveled and polished. D.C.J.

OPERATOR'S TECHNICAL REPORTS / MAPS



AQUARIUS RESOURCES CORPORATION

John F. Trotter, President

Aquarius Resources Corporation
#34-11 Peterson
C SW SE Sec. 11, T. 7S., R. 1E.
Fall River County, South Dakota
Elev. - Gr. 3679', KB 3689'
Well Permit #776

DAILY DRILLING REPORT

- 12/06/76 Moving equipment to #34-11 Peterson
- 12/07/76 Moving equipment to drillsite
- 12/08/76 Rigging up
- 12/09/76 Finished rigging up and started drilling rat hole @ 2:00 A.M.
Spudded surface hole @ 7:30 A.M. Drilled 12 1/4 in. hole to 164 ft. K.B.
Set 153 ft. of 24# 8-5/8" casing @ 164 ft. K.B. with 135 sx cement,
2% CaCl₂
- 12/10/76 Finished setting surface casing, plug down @ 1:00 A.M. Good returns
to surface. W.O.C. Expect to drill out early this afternoon.
- Drilled out at midnight.
- 12/11/76 8:00 A.M. - PTD - 319'. Lost circulation @ 386'
- 12/12/76 8:00 A.M. - PTD - 486'. Drilling. Made trip for bit @ 447'
- 12/13/76 8:00 A.M. - PTD - 688' - drilling.
- 12/14/76 8:00 A.M. - PTD - 967' - drilling in the red beds.
Drilled 279' in last 24 hours.
- 12/15/76 8:00 A.M. - PTD - 1243' - drilling. Drilled 276 ft. in last 24 hours.
Repairing mud pump - 8 hours. M.W. - 9.6; Visc. - 31
Made trip for bit #4 @ 978 ft.
- 12/16/76 8:00 A.M. - PTD - 1515' - drilling. Drilled 272 ft. in last 24 hours.
- 12/17/76 8:00 A.M. - PTD - 1663' - drilling. M.W. - 9.1, Visc. - 32
Drilled 148' in last 24 hours. Tripped for bit @ 1553'.
Dropped one drill collar - lost approximately 6 hours fishing.
Sample tops: Minnekahta - 1407' (+2282)
Opeche - 1454' (+2235)
1st Converse - 1540' ?
Converse Anhydrite - 1636' (+2053)
- 12-06-76 Moving equipment to #34-11 Peterson



307 Conroy Building • Casper, Wyoming 82601 • (307) 265-9025

	O. D.	I. D.	LENGTH	DEPTH
Drill Pipe or Tubing				
Reversing Sub	6"	2.75"	1'	
Water Cushion Valve				
Drill Pipe	4 1/2"	3.826"	1795'	
Drill Collars	6 1/4"	2.25"	242'	
Handling Sub & Choke Assembly				
Dual CIP Valve				
Dual CIP Sampler	5"	.87"	6.65'	2039'
Hydro-Spring Tester	5"	.75"	5'	2044'
Multiple CIP Sampler				
Extension Joint				
AP Running Case	5"	3"	4'	2045'
Hydraulic Jar	5"	1.5"	5'	
VR Safety Joint	5"	1"	2.5'	
Pressure Equalizing Crossover				
Packer Assembly	7"	1.53"	6'	2060'
Distributor	5"	1.68"	2'	
Packer Assembly	7"	1.53"	6'	2068'
Flush Joint Anchor				
Pressure Equalizing Tube				
Blanked-Off B.T. Running Case				
Drill Collars				
Anchor Pipe Safety Joint	5"	1.5"	4'	
Packer Assembly				
Distributor				
Packer Assembly				
Anchor Pipe Safety Joint				
Side Wall Anchor				
Drill Collars				
Flush Joint Anchor	5"	2.37"	12'	
Blanked-Off B.T. Running Case	5"	3"	4'	2086'
Total Depth				2090'

FORM 107-B1-PRINTED IN U.S.A.

EQUIPMENT DATA

LITTLE'S 00870 100 0/76

20



GEOLOGICAL REPORT AND WELL HISTORY

Aquarius - Double U - Powerco

#34-11 Peterson

Section 11, T. 7S., R. 1E.

Fall River County, South Dakota



Eldred D. Johnson
830 Trigood Dr.
Casper, Wyoming 82601
Phone: 23 4-8568



I N D E X

	<u>Page</u>
Synopsis	1
Chronological History	2
Bit Record	3
Deviation Surveys	3
Drill Stem Test Data	4
Schlumberger Log Analysis	4
Electric Log Tops	5
Sample Descriptions	5



Synopsis

Operator: Aquarius - Double U - Powerco

Well: #34-11 Peterson

Location: C/SW SE; 660' FSL, 2217' FSL
Section 11, T. 7S., R. 1E.
Fall River County, South Dakota

Area: Wildcat (Driftwood Canyon Prospect)

Elevation: 3679' Ground, 3689' K.B.

Spudded: December 9, 1976 (7:30 A.M.)

Ceased Drilling: December 22, 1976 (3:30 A.M.)

Completed: December 23, 1976 (12:30 A.M.)

Status: P & A

Total Depth: 2250' driller, 2248' log

Casing: 8-5/8" surface casing set @ 163'

Hole Size: 7-7/8" below surface to TD

Contractor: A. O. Bullock Drilling Co. - Rig #1
Tool Pusher - Ray Cottrell
Drillers - Larry Halligan, D. F. Ellsworth, Chuck Sides

Drilling Mud: Wyoming Mud Co., Casper, Wyo.
Gel-Chemical from 384' to TD
Engineer - Bruce Johnson

Lost Circulation: Lost Circulation for 5 1/2 hours @ 384'.

Coring: No cores cut.

Drill Stem Tests: Halliburton Services
DST #1; 2nd Leg, 2060'-2082' (adjusted to log from 2068'-2090')
Rec. 125' muddy water, 1838' black sulfur water.
Engineer - D. R. Rook, Gillette, Wyoming

Logs: Schlumberger Well Surveying Corp.
Ran Dual Induction-Late-log from 2248' to base of surface casing.
Ran Borehole Compensated Sonic Log w/caliper from 2248' to base of surface casing. Ran Gamma Ray log from base of surface casing to surface.
Engineer - Craig Rang, Gillette, Wyo.

Samples: All samples were delivered to American Stratigraphic Co., Casper, Wyo., for shipment to their Billings, Montana office where a cut will be made for the South Dakota State Geologist.



Page 2
#34-11 Peterson
Sec. 11-7S-1E
Fall River County, S. D.

Chronological History

<u>Date</u>	<u>8:00 A.M. Depth</u>	<u>Data</u>
12/8/76	Rigging up	
12/9/76	Drilling surface hole	Spudded @ 7:30 A.M. Drilled 12 1/2" surface hole to 163' @ 8:30 P.M.
12/10/76	PTD 163', W.O.C.	Made 163' Set 8-5/8" surface casing @163' K.B. w/135 sacks regular cement, 3% CaCl ₂ , 1/4# Flo Cele per sack. Plug down @ 1:00 A.M. W.O.C. Began drilling cement @ 6:00 P.M.
12/11/76	Drilling @ 319'.	Made 156'. Drilled out from under cement @ 2:00 A.M. Lost circulation @ 384' @ 8:45 A.M. Regained circulation and resumed drilling @ 2:45 P.M.
12/12/76	Drilling @ 486'.	Made 167'. Shut down @ 5:45 P.M. to repair pump. Resumed drilling @ 10:30 P.M.
12/13/76	Drilling @ 688'.	Made 202'.
12/14/76	Drilling @ 968'	Made 280'. Started trip @ 978' @ 10:00 A.M. Resumed drilling @ 6:30 P.M. after trip & working on pump for 4-3/4 hrs.
12/15/76	Drilling @ 1234'.	Made 266'.
12/16/76	Drilling @ 1517'.	Made 283'. Started trip @ 1553' @ 1:00 P.M. Dropped bottom hole drill collar to bottom @ 3:00 P.M. Fished out drill collar w/rig overshot and resumed drilling @ 11:45 P.M.
12/17/76	Drilling @ 1663'.	Made 146'.
12/18/76	Drilling @ 1823'.	Made 160'. Started trip @ 1852' @ 1:45 P.M. Spent 4-3/4 hrs replacing carrier bearing in torque converter. Resumed drilling @ 8:45 P.M.
12/19/76	Drilling @ 1939'.	Made 116'.
12/20/76	PTD 2086'. W.O.O.	Made 147'. Reached 2086' @ 5:30 A.M. Circulated samples & W.O.O. for DST till 8:30. Drilled to 2092' @ 9:00. Started out of hole for DST #1 @10:00 A.M. SIM 2092 = 9090



Page 3
#34-11 Peterson
Sec. 11-73-1E
Fall River County, S. D.

Began picking up test tools @ 1:00 P.M. On bottom testing @ 4:20 P.M. Finished testing @ 7:00 P.M. Out of hole w/test tools @ 11:00 P.M. DST #1; 2nd Leo, 2068-2090. Rec. 125' muddy water, 1838' blkok sulfur water.

12/21/76 Drilling @ 2133'.

Made 49'.
Resumed drilling after test @ 3:45 A.M.

12/22/76 TD 2250' going in hole w/logging tool.

Made 117'.
Reached TD of 2250' @ 3:30 A.M. Started out of hole for logs @ 5:00 A.M. Began rigging up loggers @ 7:30 A.M. Ran Dual Induction Laterolog from 2248' to base of surface casing. Ran Borehole Compensated Sonic log w/caliper from 2248' to base of surface casing. Ran Gamma Ray log from base of surface casing to surface. Finished logging @ 1:00 P.M. Prep to P & A.

12/23/76 TD 2250' driller 2248' log

Set 35 sack plug from 1900'-2000' across "Red Shale Marker".
Set 50 sack plug from 750'-900' across Basal Sundance sandstone.
Set 30 sack plug across casing shoe from 105'-190'.
Set regulation marker in top of surface casing w/10 sacks.
Plug down @ 12:30 A.M.
P & A

Bit Record

<u>Bit No.</u>	<u>Size</u>	<u>Make</u>	<u>Type</u>	<u>Serial #</u>	<u>Depth Out</u>	<u>Feet</u>	<u>Hrs Run</u>
1	7-7/8	Hughes	OSC3-J	1-Y3708	447	284	29
2	7-7/8	Hughes	J-44	Re-Run	978	531	49½
3	7-7/8	Hughes	OW4-J	RD475	1553	575	42
4	7-7/8	Hughes	J-33	Re-Built	1852	299	36½
5	7-7/8	Hughes	J-55	Re-Run	2250	398	56

Deviation Surveys

<u>Depth</u>	<u>Deviation</u>
1850	2½°



Page 4
#34-11' Peterson
Sec. 11-7S-1E
Fall River County, S. D.

Drill Stem Test Data

DST #1; 2nd Leo sandstone, 2060'-2088' (adjusted to log from drillers depth of 2068'-2090')

Open 11 min. SI 30 min. Open 60 min. SI 60 min.
Tool opened on pre-flow w/very strong blow, off bottom of 5 gal. bucket in 30 sec., remained steady for 11 min. Tool re-opened on final flow off bottom of 5 gal. bucket, began gradually decreasing after 12 min., decreased to surface bubbles after 44 min., decreasing to intermittent surface bubbles @ end of test.
No gas - to - surface.
Recovered 1963' fluid; 125' muddy water, 1838' black sulfur water. Rw = 2.16 @ 48° F. 1200 ppm chlorides.
Sample chamber contained 2175 cc black sulfur water, 0# pressure

pre-flow			final flow	
IFP 294#	ISIP 882#		IFP 593#	IHP 979#
FFI 588#	FSIP 882#		FFP 882#	FHP 983#

BHT 78° F.

Tested by Halliburton Services
Engineer - D. R. Rook, Gillette, Wyo.

Schlumberger Log Analysis

<u>Hulett sandstone</u>					<u>Basal Sundance sandstone</u>				
Depth	Rw	Rt	φ	Sw	Depth	Rw	Rt	φ	Sw
708	2.5	20	30%+	80%	870-885	5.0	20	30%+	100%
718	2.5	18	30%+	70%					

<u>1st Converse sandstone</u>					<u>2nd Converse sandstone</u>				
Depth	Rw	Rt	φ	Sw	Depth	Rw	Rt	φ	Sw
1592	8	8	30%+	70%	1686	3.5	50	28%	100%
					1728	3.5	150	12%	100%

<u>2nd Leo sandstone</u>				
Depth	Rw	Rt	φ	Sw
2078	2.0	25	30%+	80%
2088	2.0	18	30%+	85%

Engineer - Craig Bang, Gillette, Wyo.



Electric Log Tops

<u>Formation</u>	<u>Depth</u>	<u>Datum (K.B.)</u>
Morrison formation	406	+3283
Sundance formation	570	+3119
Basal Sundance sandstone	866	+2823
Spearfish formation	888	+2801
Goose Egg formation	1158	+2531
Minnekahta limestone	1412	+2277
Opeche shale	1452	+2237
1st Converse sandstone	1552	+2137
Converse anhydrite	1630	+2059
2nd Converse sandstone	1677	+2012
3rd Converse sandstone	1764	+1925
"Red Shale Marker"	1952	+1737
1st Leo sandstone zone	1964	+1725
2nd Leo sandstone zone	2062	+1627
3rd Leo sandstone zone	2168	+1521
TD	2248	+1441

Sample Descriptions

Samples were examined under the binocular microscope during the drilling of the well in December, 1976, using 10X eyepiece and 1X and 2X objective lenses. 10' samples were caught from under surface to TD. Sample quality was generally fair to good. The following sample descriptions were condensed from the well-site description with the depths adjusted to the E-log to compensate for lag.

<u>From</u>	<u>To</u>	<u>Feet</u>	<u>Description</u>
1350	1412	62	Sh, red orange, soft, silty, interbedded w/red orange siltst, soft - firm, sdy, anhy & scatt anhy, wht, fn - v fn xln, soft - firm, sucrosic - massive.
<u>Minnekahta limestone</u>			1412 (+2277) log
1412	1436	24	Dol, cream - lt tan, some lavender gray, v fn - microxln, anhy, liney in part, firm - hrd, brittle, w/anhy, wht - pink, v fn xln, massive, some sucrosic, firm.
1436	1452	16	ls, cream - wht, some pink, v fn - microxln, anhy in part, firm - hrd, brittle, w/anhy, wht, fn - v fn xln, sucrosic, some massive, soft - firm.
<u>Opeche shale</u>			1452 (+2237) log
1452	1490	38	Sh, drk rust red, soft, silty, anhy.
1490	1515	25	Sh aa, w/interbedded anhy, wht, v fn xln, sucrosic, some massive, soft - firm.
1515	1535	20	Sh, rust red, soft, silty, anhy, grndg to siltst, rust red - red red orange, firm, sdy, shly, anhy.
1535	1552	17	Sh, rust red, soft, silty, anhy & some rust red - red orange, shly, sdy, siltst aa, interbedded w/ls, wht - cream & tan, v fn -



microxln, firm - hrd, brittle, anhy, w/some anhy, wht, v fn xln, sucrosic, soft.

1st Converse sandstone 1552 (+2137) log

- 1552 1580 28 Ss, wht - lt pink & buff, fn - med grn, s ang - s rnd, anhy filled in part, sli dolo, firm - fri, fr - gd, some poor P & P, NS. Scatt anhy, wht, v fn xln, massive, some sucrosic, firm.
- 1580 1600 20 Ss, wht - pink & buff, some red @ base of interval, fn - med grn, s ang - s rnd, anhy filled in part, sli dolo, poor - gd P & P, NS. Some scatt anhy aa.
- 1600 1630 30 Ss, red - pink, some wht, fn grn, some med, s ang - s rnd, anhy filled, dolo in part, firm - fri, poor - fr, some gd P & P, NS.

Converse anhydrite 1630 (+2059) log

- 1630 1660 30 Anhy, wht, v fn xln, firm, some hrd, massive - sucrosic.
- 1660 1677 17 Anhy wht, fn - v fn xln, massive, some sucrosic, firm - soft, w/dol, pink, v fn - microxln, hrd, brittle, anhy.

2nd Converse sandstone 1677 (+2012) log

- 1677 1682 5 Ss, red - buff, fn grn, some med, s rnd - s ang, anhy filled, silty in part, dolo, firm - fri, no - poor P & P, NS.
- 1682 1690 8 Ss, lt red orange - buff, fn grn, some med, s rnd - s ang, anhy filled, dolo, firm - fri, poor - fr P & P, NS.
- 1690 1720 30 Ss, lt red orange, fn grn, some med, anhy filled, fri, no - poor P & P, NS, w/anhy, wht, v fn xln, sucrosic - massive, firm - soft.
- 1720 1736 16 Dol, lt gry w/blk mottling, & tan v fn granular, firm, limey, somewhat brittle.
- 1736 1750 14 Dol, tan - lt gry, some blk mottling, v fn - microxln, firm - hrd, brittle, limey w/some anhy, wht, fn - v fn xln, massive - sucrosic, firm - soft.
- 1750 1764 14 Anhy, wht - gry, fn - v fn xln, massive, some sucrosic, firm - hrd, some soft w/some scatt aa, wht, fn grn, s rnd - s ang, anhy filled, dolo, hrd, firm, some fri, no P & P, fat - poor lt yell fluor, no cut.

3rd Converse sandstone 1764 (+1925) log

- 1764 1774 10 Ss, wht, fn grn, s rnd - s ang, anhy filled, dolo, firm - fri, no - poor P & P, some fnt fluor, no cut, w/anhy aa, wht - gry, fn - v fn xln, massive, some sucrosic, firm - hrd, some soft.



Page 7
 #36-11 Peterson
 Sec. 11-7S-1E
 Fall River County, S. D.

1774	1796	24	Dol, tan - gry, some brn, v fn granular, some v fn - microxln, firm - hrd, brittle, limey w/some anhy, wht - brn, some gry, fn - v fn xln, massive, some sucrosic, firm - hrd, some soft. Scatt stringers of ss, wht - pink, fn grn, s rnd - s ang, anhy filled, dolo, firm - fri, no - poor P & P, some poor - fr lt yell fluor, no cut.
1796	1810	14	Dol, lt pink - cream & v lt gry, v fn - microxln, firm - hrd, brittle, anhy w/scatt ss, wht, fn grn, s rnd - s ang, anhy filled, firm - fri, no - poor P & P, fnt, tr fr lt yell fluor, no cut.
1810	1860	50	Anhy, wht - gry, fn - v fn xln, massive - sucrosic, firm - hrd, some soft w/some interbedded dol, pink - cream & lt tan - gry, v fn - microxln, some granular, firm - hrd, brittle, anhy in part, w/scatt stringers of ss, wht - lt gry, some buff, s rnd - s ang anhy filled, dolo, firm - fri, no - poor P & P, sli tr fr fluor, no cut, 99% NS.
1860	1884	24	Sh, rust red, soft, silty, anhy, sli dolo, interbedded w/dol, tan - gry, some lavender, v fn - microxln & granular, firm - hrd, brittle, anhy.
1884	1926	42	Dol lt tan - lavender pink & lt gry, v fn - microxln, firm - hrd, brittle, anhy, w/anhy wht, v fn - fn xln, massive - sucrosic, firm - soft. Scatt interbedded sh, drk rust red, soft, silty, sli dolo, anhy & some scatt ss, wht - v lt pink, fn grn, s rnd - s ang, anhy filled, dolo, firm - fri, poor - fr P & P, NS.
1926	1938	12	Dol, cream - lt tan, & pink - lt gry, v fn - microxln, hrd - firm, brittle, anhy, limey.
1938	1952	14	Dol, lt gry - tan & pink, v fn - microxln, firm - hrd, brittle, anhy, limey in part, sdy in part, w/ss, wht - lt pink, fn grn, some med, s rnd - s ang, anhy filled, dolo, firm - fri, poor P & P, tr fnt - poor fluor, no cut.
<u>"Red Shale Marker"</u>			1952 (+1737) log
1952	1964	12	Sh, rust red w/metallic luster from finely disseminated mica, v soft, fissile w/some interbedded ls @ base of interval, tan - cream, some pink, v fn - microxln, firm - hrd, brittle, dolo, & anhy, wht, v fn - fn xln, massive - sucrosic, firm - soft.
<u>1st Leo sandstone zone</u>			1964 (+1725) log
1964	1976	12	Dol, lt tan, v fn - microxln, hrd - firm, brittle, anhy.
1976	2000	24	Ss, wht - med gry & v lt pink, fn grn, s rnd - s ang, anhy filled, dolo, firm - fri, no - poor P & P, sli tr blk dead oil stn, tr fnt fluor, no cut, mostly NS, w/scatt dol, pink - cream, v fn - microxln, hrd - firm, anhy, brittle.

Page 8
 #34-11 Peterson
 Sec. 11-78-1E
 Fall River County, S. D.

2000	2020	20	Dol, med gry - gry brn, w/blk mottling, v fn granular - v fn xln, firm - hrd, brittle, anhy, limey & anhy w/brn mottling, v fn xln, massive, some sucrosic, firm, w/some ss, med gry - tan, fn grn, s rnd - s ang, anhy filled, dolo, firm - fri, no P & P, some tr blk dead oil stn, poor - fr lt yell fluor, no cut.
2020	2046	26	Dol tan - brn & gry, v fn - microxln, some granular, hrd - firm, brittle, anhy, somewhat limey w/interbedded anhy, wht w/some brn mottling, fn - v fn xln, massive, some sucrosic, firm - soft.
2046	2062	16	Dol, tan - gry brn, v fn xln - granular, firm - hrd, anhy, somewhat limey, brittle w/ss, wht - tan, fn grn, some med, s rnd - s ang, anhy filled in part, dolo, firm - fri, no - fr P & P, some tr blk dead oil stn, sli tr brn oil (?) stn, fnt lt yell fluor, no cut. Some tr hrd blk carb, silty sh @ base of interval.

2nd Leo sandstone zone 2062 (+1627) log

2062	2072	10	Dol tan - lt gry, v fn xln, sdy, hrd, brittle, grng in part to v dolo ss, w/interbedded wht ss, fn grn, s rnd - s ang, anhy filled in part, dolo in part, firm - fri, poor - fr P & P, fnt - poor fluor, no cut.
2072	2102	30	Ss, wht - clear, fn - med grn, s rnd - s ang, anhy matrix, sli dolo, fri, fr - gd P & P, sli tr blk dead oil stn, fnt lt yell fluor, no cut.

Samples were circulated @ 2076' and 2082' for 1 hr @ each point before DST #1
 DST #1; 2060'-2082' (adjusted to log from 2068'-2090' driller's depth)
 (See page 4 for DST data)

2102	2110	8	Ss, lt gry, fn grn, s rnd - s ang, anhy filled, dolo, firm, no P & P, poor - fr lt yell fluor, no cut.
2110	2146	36	Dol, med gry - brn & tan, v fn - microxln, hrd, brittle w/scatt anhy, wht, v fn xln, massive - sucrosic, & some scatt ss, lt gry, fn grn, s rnd - s ang, anhy filled, dolo, firm, no P & P, poor - fr lt yell fluor, no cut. Some interbedded sh, hrd, blk, carb, silty, brittle.
2146	2168	22	Dol, med gry - grn brn, some tan, v fn - microxln, some v fn granular, firm - hrd, brittle, anhy, w/some scatt ss, lt med gry, fn grn, s rnd - s ang, anhy filled, dolo, firm, no P & P, poor - fr fluor, no cut. Scatt blk, carb silty, sh, firm - hrd.

3rd Leo sandstone zone 2168 (+1521) log

2168	2178	10	Ss, wht, fn grn, s rnd - s ang, anhy filled, sli dolo, firm - fri, no - poor P & P, fnt lt yell fluor, no cut.
2178	2204	26	Dol, tan, v fn - microxln, firm - hrd, brittle, anhy w/anhy, wht, fn - v fn xln, massive, some sucrosic, firm - soft. Some blk carb silty sh @ base of interval, firm - hrd.

Page 9
#34-11 Peterson
Sec. 11-7S-1E
Fall River County, S. D.

2204 2250 46 Dol, tan - gry crs. v fn - microxin & v fn granular, firm - hrd, brittle w/some interbedded ss, wht, fn - v fn xln, massive - sucrosic, firm - soft. Some scatt stringers of ss, wht - lt gry & tan, fn grn. s rnd - s ang, anhy filled, idolo, firm - hrd, no P & F, or blk dead oil stn, fnt - fr, some gd lt yell flour, no cut.

Samples circulated for 1 hr @ TD before logging

TD 2250' drilled
2248' log

Drilling time was kept on a Geolograph drilling time recorder. A drilling time log was constructed for each 2' interval on a scale of 5" = 100' from 1300' to TD. Both the original drilling time chart and the drilling time log were delivered to the offices of Aquarius Resources Corp., Jasper, Wyo.

Eldred W. Johnson



	O. D.	I. D.	LENGTH	34 of 47 DEPTH
Drill Pipe or Tubing	6"	2.75"	1'	
Reversing Sub				
Water Cushion Valve				
Drill Pipe	4 1/2"	3.826"	1795'	
Drill Collars	6 1/4"	2.25"	242'	
Handling Sub & Choke Assembly				
Dual CIP Valve				
Dual CIP Sampler	5"	.87"	6.65'	2039'
Hydra-Spring Tester	5"	.75"	5'	2044'
Multiple CIP Sampler				
Extension Joint				
AP Running Case	5"	3"	4'	2045'
Hydraulic Jar	5"	1.5"	5'	
VR Safety Joint	5"	1"	2.5'	
Pressure Equalizing Crossover				
Packer Assembly	7"	1.53"	6'	2060'
Distributor	5"	1.68"	2'	
Packer Assembly	7"	1.53"	6'	2068'
Flush Joint Anchor				
Pressure Equalizing Tube				
Blanked-Off B.T. Running Case				
Drill Collars	5"	1.5"	4'	
Anchor Pipe Safety Joint				
Packer Assembly				
Distributor				
Packer Assembly				
Anchor Pipe Safety Joint				
Side Well Anchor				
Drill Collars				
Flush Joint Anchor	5"	2.37"	12'	
Blanked-Off B.T. Running Case	5"	3"	4'	2086'
Total Depth				2090'

FORM 87-81-PRINTED IN U.S.A.

EQUIPMENT DATA

LITTLE'S CORP 500 01/01

2.0

Gauge No.	48			2045'			9984			12 hour			771061		
	Time Defl. .000"	PSIG Temp. Corr.	Time Defl. .000"	PSIG Temp. Corr.	Time Defl. .000"	PSIG Temp. Corr.	Time Defl. .000"	PSIG Temp. Corr.	Time Defl. .000"	PSIG Temp. Corr.	Time Defl. .000"	PSIG Temp. Corr.	Time Defl. .000"	PSIG Temp. Corr.	
0	.0000	288	.0000	624	.0000	651	.0000	880	.0000	880	.0000	880	.0000	880	
1	.0199*	389	.0068**	836	.0738***	790	.39150	882							
2	.0332	462	.0203	857	.1408	847									
3	.0465	523	.0338	863	.2079	868									
4	.0597	576	.0473	868	.2749	876									
5	.0730	624	.0608	870	.3419	878									
6			.0744	872	.4090	880									
7			.0879	874											
8			.1014	876											
9			.1149	876											
10			.1284	878											
11			.1420	878											
12			.1555	880											
13			.1690	880											
14			.1825	880											
15			.1960	880											

Gauge No.	47			2086'			9479			12 hour		
	Time Defl. .000"	PSIG Temp. Corr.	Time Defl. .000"	PSIG Temp. Corr.	Time Defl. .000"	PSIG Temp. Corr.	Time Defl. .000"	PSIG Temp. Corr.	Time Defl. .000"	PSIG Temp. Corr.	Time Defl. .000"	PSIG Temp. Corr.
0	.0000	337	.0000	635	.0000	676	.0000	894	.0000	894	.0000	894
1	.0199*	415	.0068**	849	.0731***	806	.3920	898				
2	.0332	479	.0204	870	.1395	860						
3	.0465	538	.0340	877	.2059	881						
4	.0597	587	.0476	883	.2723	890						
5	.0730	635	.0612	888	.3387	891						
6			.0747	888	.4050	894						
7			.0883	888								
8			.1019	890								
9			.1155	892								
10			.1291	892								
11			.1427	894								
12			.1563	894								
13			.1699	894								
14			.1835	894								
15			.1971	894								

Reading Interval 2
 REMARKS: *First interval is equal to 3 minutes. ** = 1 minute *** = 11 minutes.

LITTLE # 9073 PG 6/74

SPECIAL PRESSURE DATA

FORM NO. 01-PRINTED IN U.S.A.



Casing perms. _____ Bottom choke _____ Surf. temp. _____ °F Ticket No. _____
 Gas gravity _____ Oil gravity _____ GOR _____
 Spec. gravity _____ Chlorides _____ ppm Res. _____ °F

INDICATE TYPE AND SIZE OF GAS MEASURING DEVICE USED _____

Date Time	a.m. p.m.	Choke Size	Surface Pressure psi	Gas Rate MCF	Liquid Rate BPD	Remarks
1300						On location
1315						Made up tools
1355						Started in hole
1615						Opened tool with a strong blow at bottom of bucket, remained same until closed in.
1625						Closed tool, blow died in 9 minutes.
1655						Opened tool with blow at bottom of bucket, after 12 minutes appeared to start decreasing.
						In 28 minutes had 1" off bottom of bucket.
						In 35 minutes had 9½" into bucket
						In 37 minutes had 2½" in bucket
						In 38 minutes had 1½" in bucket
						In 40 minutes had 1" in bucket
						In 42 minutes - 1/2" in bucket
						In 44 minutes had surface bubbles.
						Remained same until closed in.
1755						Closed tool - dead.
1855						Pulled loose with no trouble.

PRODUCTION TEST DATA



ADMINISTRATIVE / SUNDRY REPORTS

PLUGGING RECORD

Operator AQUARIUS RESOURCES CORPORATION		Address 307 Conroy Building, Casper, Wyoming 82601	
Name of Lease Peterson	Well No. 34-11	Field & Reservoir	
Location of Well C 3/4 SE Section 11-7S-1E		Sec-Twp-Rge or Block & Survey	County Fall River
Application to drill this well was filed in name of Aquarius Resources Corp.	Has this well ever produced oil or gas NO	Character of well at completion (Initial production): Oil (bbbl/day) Gas (MCF/day) Dry? None None None	
Date plugged December 23, 1976	Total depth 2250'	Amount well producing when plugged Oil (bbbl/day) Gas (MCF/day) Water (bbbl/day) None None None	
Indicate each formation containing fresh water open to well bore at time of plugging	Fluid content of each formation	Depth interval of each formation	Size and depth of plugs used
Minnelusa-Leo	sulphur water	1963	50 sx 1900-2000
Converse	Gyp water	1952	
Sundance-basal	water	819	50 sx 750- 900
Base Surf. Csg.	-	162	25 sx 130- 140
Top Surf. Csg.	-	Dry hole marker	10 sx

CASING RECORD

Size pipe	Put in well (ft.)	Pulled out (ft.)	Left in well (ft.)	Give depth and nature of part of casing (shot ripped etc.)	Parkers and Sigsbee
4-5/8"	162 ft.		162 ft.		

Was well plugged with mud laden fluid, according to regulations? **Yes** Indicate deepest formation containing fresh water **Fall River-Lakota**

In case of other information required on this form, if this well was plugged back for use as a fresh water well give all pertinent details of plugging operations to base of fresh water sand, perforated interval to fresh water sand, name and address of surface owner, and attach certificate of surface owner authorizing completion of this well as a water well and agreeing to assume full liability for any subsequent plugging which might be required.

Fall River-Lakota - behind surface casing in part	Minnelusa
Morrison - 406	Converse 1552
Sundance - 570	Red Marker 1952
basal sand - 819	Leo 1964
Spearfish - 866	Total Depth 2250 dril. & SCH.
Goose Egg - 1158	
Hinnekahta - 1412	
Opache - 1452	

USE REVERSE SIDE FOR ADDITIONAL DETAIL

Executed this the **30th** day of **December**, 19**76**

State of **Wyoming**

County of **Natrona**

Signature of Affiant: *John F. Trotter*

Before me, the undersigned authority, on this day personally appeared **John F. Trotter** known to me to be the person whose name is subscribed to the above instrument, who being by me duly sworn on oath states, that he is duly authorized to make the above report and that he has knowledge of the facts stated therein, and that said report is true and correct.

Subscribed and sworn to before me on this **30th** day of **December**, 19**76**

SEAL: **WYOMING** Notary Public
 My Commission expires **11/1978** State of **Wyoming**
 Notary Public in and for **Natrona** County, **Wyoming**

Approved **Jan. 5, 1977** Date

DO NOT WRITE BELOW THIS LINE

OIL AND GAS BOARD OF THE STATE OF SOUTH DAKOTA

John W. Stearns Supervisor

JAN 1977
 FIELD OFFICE

See 13-2 copies of this form with Secretary, Oil

CORRESPONDENCE

NOV 15 1976

November 10, 1976

Aquarius Resources Corporation
307 Conroy Building
Casper, WY 82601

Attention John F. Trotter

Gentlemen:

Enclosed is your copy of Permit #776 (Form 2a) and approved Application to Drill (Form 2) covering the Aquarius #34-11 Peterson oil test in Fall River County, South Dakota. A copy of the permit should be posted at the well site. Also enclosed is a receipt for your \$100 permit fee.

Please make weekly drilling progress reports to the Western Field Office.

May I wish you success in your drilling venture and if there is anything I can do to be of help, please let me know.

Sincerely,

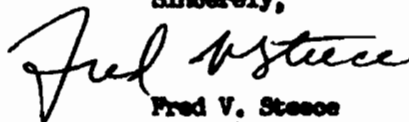

Fred V. Steece
Supervisor, Western Field Office

FVS/jm
Enc. 3

cc: Dr. Duncan J. McGregor
Mr. Vern W. Butler
Dr. Allyn Lockner
Mr. George Kane



SURETY

**NO SURETY INFORMATION FOR
THIS WELL AS OF 5/18/2011**



MISCELLANEOUS



**NO MISCELLANEOUS
INFORMATION FOR THIS WELL
AS OF 5/18/2011**



Oil and Gas Search for: <i>api_no_ like '40 047 20074'</i>		
Page 1 of 1	<u>Download Database</u> (Excel spreadsheet format)	Page: Prev 1 <input type="button" value="v"/> Next

Record 1 of 1

Well Information

API No:	40 047 20074	County:	FALL RIVER
Well Name:	WULF 1 PETERSON	Location:	NENE 21-7S-1E
Permit No:	903	Total Depth:	2500
Operator Name:	CRYSTAL OIL COMPANY	Bottom Hole:	Minnelusa
Permit Date:	12-13-1978	KB Elevation:	3539
Spud Date:	03-10-1979	Ground Elevation:	3533
Plug Date:		Latitude:	43.433117
		Longitude:	-103.997735
Well Field	WILDCAT	Status	P&A
Class:	DRY HOLE	Type:	DRY HOLE

Formation Tops

<u>Formation</u>	<u>Depth (ft.)</u>
Dakota Mud	235
Lakota	545
Sundance	840
Minnelusa	1840
Red Marker	2267
1st Leo	2290
2nd Leo	2382

Page 1 of 1 (goto top)	Page: Prev 1 <input type="button" value="v"/> Next
-------------------------------	---

COUNTY: FALL RIVER
LEGAL LOCATION: NENE 21-7N-1E
API NO: 40 047 20074
PERMIT NO: 903
WELL NAME: WULF #1 PETERSON
OPERATOR: CRYSTAL OIL COMPANY
PERMIT ISSUED: 12/13/1978
PERMIT CLOSED: 05/08/1979
FILE LOCATION: 7N-1E-21 NENE

TARGET CODES:

WELL HISTORY / CHECKLIST

PERMIT TO DRILL / INTENT TO DRILL

WELL INSPECTION / SCOUT REPORTS

OPERATOR'S TECHNICAL REPORTS / MAPS

ADMINISTRATIVE / SUNDRY REPORTS

CORRESPONDENCE

SURETY

MISCELLANEOUS

WELL HISTORY / CHECKLIST

BOND RELEASE CHECKLIST

Well Name & Location		Permit # <u>903</u>
Wulf #1 Peterson NENE 21-7S-1E, Fall River		API # <u>40 047 20074</u>
Bond # <u>708E675-4</u>	Date Issued <u>10-25-78</u>	Date Released <u>OCT 03 1986</u>

Surface Restoration

- Pits filled .
- Site Level
- Site policed
- NA Dry-hole marker solid, sealed, correctly inscribed
- No dry-hole marker desired, letter in WFO files from surface owner
- Letter of approval from surfaceowner.

Paperwork filed

- Form 4 (Completion or Recompletion Report)
- Form 6 (Sundry Notices and Report on Wells)
- Form 7 (Plugging Report)

Geological Information Filed

- Well logs: IFS, SNP, DIL, GR, NEUT, CALIP, (Cement Bond) Term, Micro, Laterlog, SM Dens. BCSL DI-SR
- NA DST Charts and Reports
- Geologist's Report
- Results of coring and core analyses
- Set of 10-foot sample cuttings (check with Bob Schoon)
- Crystal *1 Peterson - Core from 2378' - 2424' - at SP1772

Date OCT 3 1986 Checked By JK Steece



PERMIT CHECKLIST

Well Name and Location:	Permit # <u>903</u>
Wulf #1 Peterson NENE 21-7S-1E, Fall River	API # <u>40 047 20074</u>
	Bond # <u>708E675-4</u>

Paperwork filed with WFO

- X Organization Report
- X Application
- X Bond
- X Permit Fee

The Following Papers sent to Operator:

- X Permit (Form 2a)
- X Receipt for \$100 permit fee
- X Cover letter explaining material sent

Permit Fee Filed:

- X Permit fee w/Cash Receipts Transmittal Form sent to State Treasurer

Notification of New Permit sent to:

- X Dr. Duncan J. McGregor
- X Mr. Vern W. Butler
- X Dr. Allyn Lockner
- X Mr. George Kane

DATE 12-13-78 CHECKED BY Cheryl Pederson



PERMIT TO DRILL / INTENT TO DRILL

State Pub. Co., Pierre

APPLICATION FOR PERMIT TO:

S. Dak Oil & Gas Board
FORM 2

<input checked="" type="checkbox"/> DRILL	<input type="checkbox"/> DEEPEN	<input type="checkbox"/> PLUG BACK	FARM OR LEASE NAME <u>Peterson</u>
<input checked="" type="checkbox"/> OIL WELL	<input type="checkbox"/> GAS WELL	<input checked="" type="checkbox"/> SINGLE ZONE	WELL NO. <u>#1</u>
<input type="checkbox"/> MULTIPLE ZONE			FIELD AND POOL OR WILDCAT <u>Wildcat</u>
OPERATOR <u>Wulf Oil Corporation</u>			NO. ACRES IN LEASE <u>1200.00</u>
ADDRESS <u>P. O. Box 1320 - Chadron, Nebraska 69337</u>			1/4 SEC. TWP. RGE <u>NE 1/4 Sec. 21, T7S, R1E</u>
LOCATION (In feet from nearest lines of section or legal subdivision, where possible)* <u>660' FNL - 658' FEL Section 21</u>			COUNTY <u>Fall River</u>
NAME AND ADDRESS OF SURFACE OWNER <u>Peterson & Son, Inc. Edgemont, S. D.</u>		ELEVATION <u>3,533 CB</u>	NO. OF WELLS ETC. <u>1</u>
NAME AND ADDRESS OF CONTRACTOR <u>Northern Wyoming Drilling Co., Inc. Box 746 Chadron, Nebraska 69337</u>		PROPOSED DEPTH <u>2,400'</u>	ROTARY OR CABLE TOOLS <u>Rotary</u>
IF LEASE PURCHASED WITH ANY WELLS DRILLED, FROM WHOM PURCHASED (Name and address) <u>N/A</u>			APPROXIMATE DATE WORK WILL START <u>December 28, 1978</u>

PROPOSED CASING AND CEMENTING PROGRAM

SIZE OF HOLE	SIZE OF CASING	WEIGHT PER FOOT	NEW OR SECOND HAND	DEPTH	SACKS OF CEMENT
XXXX 12 1/2"	8 5/8"	24#	New	250'	200 sx.
7 7/8"	5 1/2"	15.50#	New	2,400'	150 sx.

DESCRIBE PROPOSED OPERATIONS. IF PROPOSAL IS TO DEEPEN OR PLUG BACK, GIVE DATA ON PRESENT PRODUCTIVE ZONE AND PROPOSED NEW PRODUCTIVE ZONE. GIVE BLOW OUT PREVENTER PROGRAM IF ANY

We plan to drill a 2,400' well into the Leo Formation. We plan to start the well Dec. 28, 1978 with operations lasting approximately 14 days.

Northern Wyoming Drlg. Rig #2 is equipped with a 10" Ragan Blowout Preventor which will be used while drilling the well.



SIGNED Dennis R. Steel TITLE Vice-President Operator DATE 12-1-78

DO NOT WRITE BELOW THIS LINE

PERMIT NO. 903

DATE ISSUED December 13, 1978

CONDITIONS:

- COMPLETE SET OF SAMPLES, AND CORES IF TAKEN, MUST BE SUBMITTED.
- SAMPLES AND CORES IF TAKEN, BELOW SOUTH DAKOTA DEPTH, MUST BE SUBMITTED.

CHECKED BY Fred W. Steele School and Public Lands Date
Supervisor, Western Field Office

STATE GEOLOGICAL SURVEY
WESTERN FIELD OFFICE



PLAINS ENGINEERING

A DIVISION OF MCKINIS-WESTERN-SONDEREGGER, INC.
ENGINEERS • ARCHITECTS • PLANNERS • SURVEYORS

P.O. BOX 727 • NEWCASTLE, WY 82701 • 307-766-2784
1413 MAIN ST. • INLES CITY, MT 59301 • 406-522-6666
P.O. BOX 432 • BUFFALO, WY 82834 • 307-484-7976
S.M.PAL BLDG. • HOT SPRINGS, SD 57747 • 605-745-0880
P.O. BOX 2020 • GILLETTE, WY 82716 • 307-682-7285

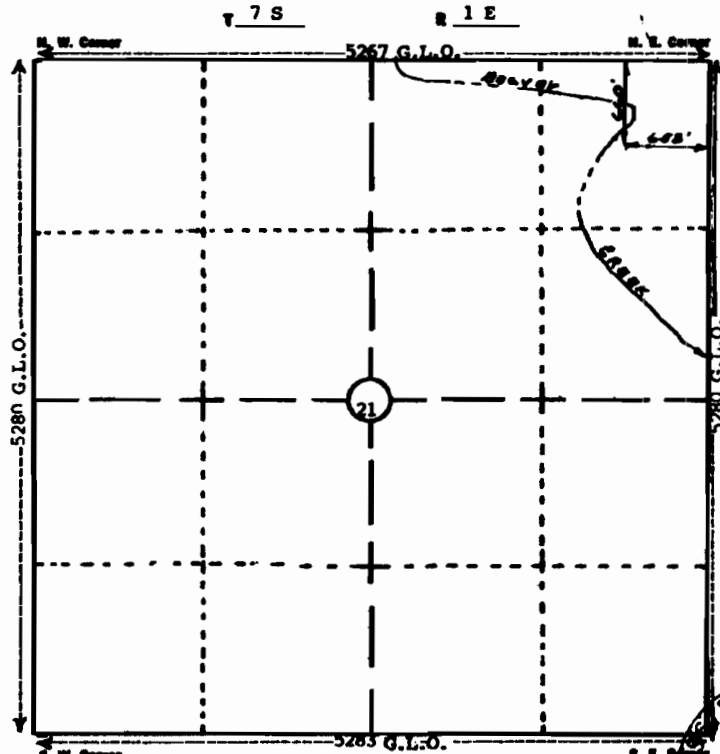

Elevation at the following reference points:

- 130' North (on bank of Beaver Creek) - 3532'
- 150' West (on bank of Beaver Creek) - 3533'
- 200' South - 3532'
- 200' East (possible alternate site) - 3537.4'

I, Lawrence T. Price of Newcastle, Wyoming, certify
that in accordance with a request from Sherry Samuels
of Gillette, Wyoming, for Mulf Oil Corp.
P. O. Box 1320, Chadron, Nebraska 69337

That I XXXXXXXXXXXXXXXXXXXX
made a survey (date) November 29, 19 78
for the location and elevation of the #1 Peterson Well site

As shown on above map, the well site is in NE 1/4 NE 1/4
Section 21, Township 7 South, Range 1 East
Fall River County, South Dakota, Elevation is 3533 feet
above mean sea level before dozing.

Lawrence T. Price
Licensed Surveyor No.

789663.54
Notes in Ek 312 Pg 46



WELL INSPECTION / SCOUT REPORTS



SOUTH DAKOTA GEOLOGICAL SURVEY
Western Field Office

SCOUT REPORT

Number 4

Date Scouted 8-7-79

Operator Wulf Oil & Crvstal

Permit Number 903

Farm/Lease Name #1 Peterson

API Number 40 047 20074

NENE Sec. 21 T. 7S R. 1E

County Fall River

Elev. 3533 Gr. Est. T.D. 2400 Actual T.D. 2500 Spudded 3-10-79

Contractor N. Wyoming Drilling Geologist Jim Cox

SCOUT'S OBSERVATION:

DST RECORD:

Site clean, level, no dry hole marker (as requested by landowner), site approved.

FORMATION TOPS:

PLUGGING RECORD:

DATE PLUGGED/COMPLETED 4-7-79

CASING RECORD:

SITE INSPECTION:

8 5/8 From 0 To 250

Approved X

From _____ To _____

Not Approved _____

REMARKS:

SCOUTED BY Tim Kenyon
Tim Kenyon
Geologic Assistant

Fred V. Steece
Fred V. Steece, Supervisor
Western Field Office



SOUTH DAKOTA GEOLOGICAL SURVEY
Western Field Office

SCOUT REPORT

Number 213

Date Scouted _____

Operator Wulf Oil & Crystal

Permit Number 903

Farm/Lease Name #1 Peterson

API Number 40 047 20074

NENE Sec. 21 T. 7S R. 1E

County Fall River

Elev. 3533 Gr. Est. T.D. 2400 Actual T.D. 2500 Spudded 3-10-79

Contractor Northern Wyoming Drilling Geologist Jim Cox

SCOUT'S OBSERVATION:

DST RECORD:

4-9-79: Pits filled but surface is not leveled. Surface plug not in yet, and no dry hole marker erected. Dozer still at site.

5-15-79: Pits filled and surface leveled to original topography. No seed planted.

FORMATION TOPS:

PLUGGING RECORD:

DATE PLUGGED/~~COMPLETED~~ 4-7-79

CASING RECORD:

8 5/8 From 0 To 250

From _____ To _____

SITE INSPECTION:

Approved _____

Not Approved _____

REMARKS:

Mr. Peterson requested that no dry hole marker be erected. Peterson also wanted us to hold the bond since he and Joe Banks haven't come to an agreement yet.

SCOUTED BY

John Fricke
John Fricke
Geologic Assistant

Fred V. Steece
Fred V. Steece, Supervisor
Western Field Office



SOUTH DAKOTA GEOLOGICAL SURVEY
Western Field Office
SCOUT REPORT

Number 1

Date Scouted _____

Operator Wulf Oil & Crystal

Permit Number 903

Farm/Lease Name #1 Peterson

API Number 40 047 20074

NENE Sec. 21 T. 7S R. 1E

County Fall River

Elev. 3533 Gr Est. T.D. 2400

Actual T.D. _____ Spudded 3-10-79

Contractor Northern Wyoming Drilling

Geologist Jim Cox, Gillette WY

Joe Banks, owner, Gillette, WY

SCOUT'S OBSERVATION:

DST RECORD:

3-6-79: Still MIRT'S, performing minor repairs.

3-22-79: Drilling at 2434. DST #1, 2nd Leo (misrun). Presently down hole with core barrel (core #4). Plan to drill down to 2500'. Good oil shows reported in cores #1 & #3.

FORMATION TOPS:

PLUGGING RECORD:

DATE PLUGGED/COMPLETED _____

- Core #1, 17', 2378-2395
- #2, 2', 2395-2397
- #3, 25', 2397-2422
- #4, 12', 2422-2434

CASING RECORD:

8 5/8 From 0 To 250

From _____ To _____

SITE INSPECTION:

Approved _____

Not Approved X

REMARKS:

Mylo Wisman, toolpusher. Will probably spud tomorrow, and test should last approximately 2 weeks. Location extremely muddy.

SCOUTED BY

John Fricke

John Fricke
Geologic Assistant

Fred V. Steece

Fred V. Steece, Supervisor
Western Field Office



Wulf #1 Peterson

75-10-21 NE 15
SR

5/22/95: MM received a call from Wayne Peterson, the landowner. He discovered water surfacing in his alfalfa field several months ago, near the well location. He dug down almost to the wellhead, and the flow increased substantially. Mr. Peterson dug a trench away from the wellhead to keep his alfalfa from damage.

5/30/95: MM inspected the site, accompanied by Wayne Peterson. The flow was estimated at 10 gpm, and since the Inyan Kara and Sundance both exhibit artesian conditions in that area, it was possible the flow was emanating from either (or both) of those formations, travelling up the 5 1/2, 8 5/8 csg annulus.

6/1/95: FVS contacted Sam Clinton w/ Crystal Oil Co. Mr. Clinton assured FVS Crystal was a responsible co. and would fix the problem.

6/1/95: Pat Eddings (Crystal) called FVS and requested info from well files, which were faxed that day.

6/6/95: Received fax from Pat Eddings, Updike Brothers Well Service (Newcastle, WY), had been contracted to plug well.

8/22/95: Received fax from Ed Gibbs (Updike Bro.s) with Sundry of proposed P&A procedure.

8/24/95: MM called Ed Gibbs, approved P&A procedure. Ed said planning to move rig on-site the following week.

8/31/95: MM witnessed P&A (see procedure above).

9/11/95: Received Sundry from Ed Gibbs (Updike Bro.s) w/ P&A procedure. Approved by FVS.

OPERATOR'S TECHNICAL REPORTS / MAPS



CORE ANALYSIS RESULTS FOR

CRYSTAL OIL COMPANY

#1 PETERSON

WILDCAT

FALL RIVER COUNTY, SOUTH DAKOTA



PAGE NO. 1

DATE : 3-19-79
 FILE NO. : RP-4-5055-H
 ANALYSTS : BOWEN
 ELEVATION: 3533 GR

CORE LABORATORIES, INC.
Petroleum Reservoir Engineering
 DALLAS, TEXAS

CRYSTAL OIL COMPANY

FORMATION : MINNELUSA
 DRLG. FLUID: WATER BASE MUD
 LOCATION : NE NE SEC 21 T79-R1E
 STATE : SOUTH DAKOTA

#1 PETERSON
 WILDCAT
 FALL RIVER COUNTY

CONVENTIONAL CORE ANALYSIS

SAMP. NO.	DEPTH	PERM. TO AIR (MD) HORZ.	VERTICAL	POR. FLD.	FLUID SATS.		GR. DNS.	DESCRIPTION
					OIL	WATER		
	2378-2385							ANHYDRITE-NO ANALYSIS
1	2385-86	0.02		3.0	14.5	80.0		DOL, LTBRN VFXLN
2	2386-87	0.03		2.9	15.4	77.2		DOL, LTBRN VFXLN
3	2387-88	0.05		2.1	19.6	68.5		DOL, LTBRN VFXLN
4	2388-89	0.08		1.6	24.8	49.6		SS, GY VFG
5	2389-90	0.08		1.7	11.8	47.2		SS, GY VFG
6	2390-91	0.08		2.0	41.8	31.3		SS, GY VFG
7	2391-92	0.08		2.2	27.9	46.5		SS, GY VFG CALC
8	2392-93	0.07		2.7	7.6	60.6		SS, GY VFG
9	2393-94	0.14		2.0	10.4	62.4		SS, GY VFG
10	2394-95	0.05		2.3	9.0	63.0		SS, GY VFG
11	2395-96	0.05		7.2	0.0	91.2		SS, LTGY FG
12	2396-97	0.06		8.2	2.5	87.9		SS, LTGY FG
13	2397-98	0.06		8.7	0.0	86.7		SS, LTGY FG
14	2398-99	6.1		11.3	15.5	65.5		SS, LTGY FG
15	2399-00	0.18		11.0	5.5	76.4		SS, LTGY FG
16	2400-01	13		30.5	16.8	48.3		SS, LTGY FG P/CMT
17	2401-02	977		24.9	21.1	40.0		SS, LTGY FG P/CMT
18	2402-03	4.7		15.2	7.6	80.9		SS, LTGY FG
19	2403-04	4.5		12.6	3.2	75.8		SS, LTGY FG
	2404-2406							SHALE-NO ANALYSIS
20	2406-07	10		13.1	1.4	88.9		SS, LTGY VFG SL/CALC
21	2407-08	98		21.6	0.9	94.2		SS, LTGY VFG
22	2408-09	137		14.2	0.0	90.7		SS, LTGY VFG
23	2409-10	4.0		18.5	21.4	49.0		SS, LTGY FG

28° API

34° API

VF = VERTICAL FRACTURE

These analyses, opinions or interpretations are based on observations and materials supplied by the client to whom, and for whose exclusive and confidential use, this report is made. The interpretations or opinions expressed represent the best judgment of Core Laboratories, Inc. (all errors and omissions excepted), but Core Laboratories, Inc. and its officers and employees, assume no responsibility and make no warranty or representation, as to the productivity, proper operation, or performance of any oil, gas or other mineral well or used in connection with which such report is used or relied upon.

PAGE NO. 2

CORE LABORATORIES, INC.
Petroleum Reservoir Engineering
DALLAS, TEXAS

CRYSTAL OIL COMPANY

DATE : 3-19-79
FILE NO. : RP-4-5055-H
ANALYSTS : BOWEN
ELEVATION: 3533 GR

FORMATION : MINNELUSA
ORLG. FLUID: WATER BASE MUD
LOCATION : NE NE SEC 21 T78-R1E
STATE : SOUTH DAKOTA

#1 PETERSON
HILDCAT
FALL RIVER COUNTY

CONVENTIONAL CORE ANALYSIS

SAMP. NO.	DEPTH	PERM. TO AIR (MD)		POR. FLD.	FLUID SATS.		GR. DNS.	DESCRIPTION
		HORZ.	VERTICAL		OIL	WATER		
24	2410-2417			15.9	0.0	80.6		LOST RECOVERY
25	2417-18	0.58		17.8	0.0	71.3		SS, LTGY FG
26	2418-19	18		16.9	0.0	91.4		SS, LTGY FG
27	2419-20	53		15.9	0.0	89.7		SS, LTGY FG
28	2420-21	69		16.9	0.0	92.3		SS, LTGY FG
29	2421-22	48		2.7	0.0	81.4		SS, GY VFG ABNT/ANHY
30	2422-23	0.08		3.2	0.0	95.3		SS, GY VFG ABNT/ANHY
31	2423-24	0.09		2.5	0.0	88.0		SS, GY VFG
32	2424-25	0.08		3.1	0.0	78.7		SS, GY VFG
33	2425-26	0.17		2.8	0.0	84.1		SS, GY VFG
34	2426-27	0.08		2.4	0.0	91.7		SS, GY VFG
35	2427-28	0.13		3.8	0.0	97.4		SS, GY VFG
36	2428-29	0.08		4.2	0.0	92.7		SS, GY VFG
37	2429-30	0.05		2.7	0.0	92.4		SS, GY VFG
38	2430-31	0.07		2.9	0.0	91.7		SS, GY VFG
	2431-32	0.02						SHALE-NO ANALYSIS
	2432-2434							

VF = VERTICAL FRACTURE

These analyses, opinions or interpretations are based on observations and materials supplied by the client to whom, and for whose exclusive and confidential use, this report is made. The interpretations or opinions expressed represent the best judgment of Core Laboratories, Inc. (all errors and omissions excepted); but Core Laboratories, Inc. and its officers and employees, assume no responsibility and make no warranty or representation, as to the productivity, proper operation, or profitability of any oil, gas or other mineral well or used in connection with which such report is used or relied upon.



CORE LABORATORIES, INC. *Petroleum Reservoir Engineering*

COMPANY CRYSTAL OIL FIELD WILDCAT FILE NP-4-5085
 WELL #1 PETERSON COUNTY FALL RIVER DATE 3-19-79
 LOCATION NE NE SEC 21 T7S-R1E STATE SOUTH DAKOTA ELEV. 3633 GR

CORE-GAMMA CORRELATION

These recovery estimates represent theoretical maximum values for solution gas and water drive. They assume that production is started at original reservoir pressure; i.e., no account is taken of production to date or of prior drainage to other areas. The effects of factors tending to reduce actual ultimate recovery, such as economic limits on oil production rates, gas-oil ratios, or water-oil ratios, have not been taken into account. Neither have factors been considered which may result in actual recovery intermediate between solution gas and complete water drive recoveries, such as gas cap expansion, gravity drainage, or partial water drive. Reasonable predictions of ultimate oil recovery to specific abandonment conditions may be made in an engineering study in which consideration is given to overall reservoir characteristics and economic factors.

VERTICAL SCALE 5" = 100'

CORE-GAMMA SURFACE LOG
(PATENT APPLIED FOR)

COREGRAPH

GAMMA RAY
RADIATION INCREASE →

TOTAL WATER
PERCENT TOTAL WATER
 80 60 40 20 0

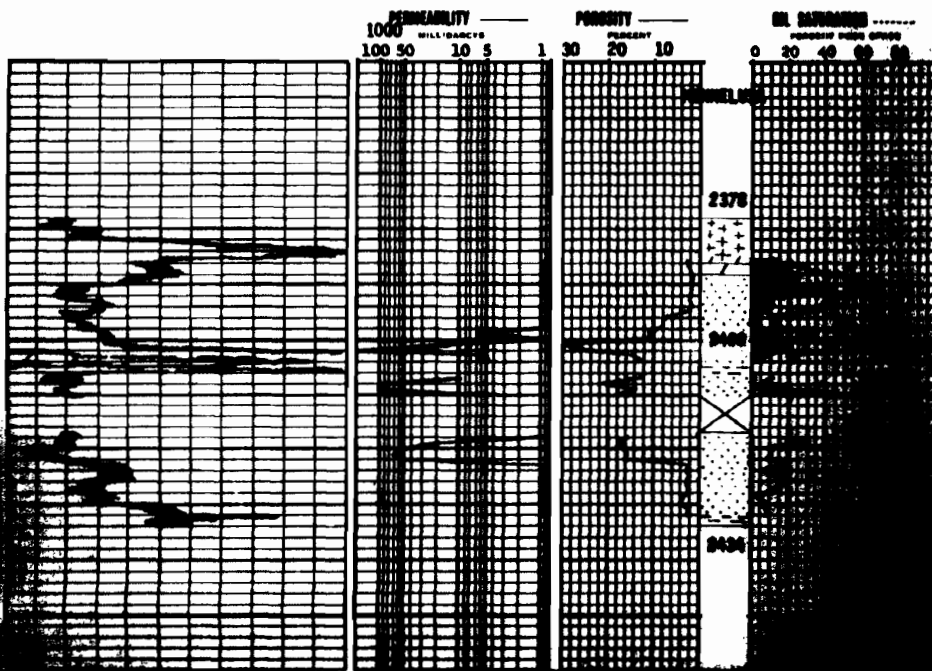

INTERPRETATION OF DATA

- 2386.0-2398.0 Feet - Non productive due to low permeability and porosity.
- 2398.0-2404.0 Feet - Oil productive characteristics-thin zone. Erratic oil saturations indicate high water cut could be expected.
- 2406.0-2432.0 Feet - Water productive where permeable.

These recovery estimates represent theoretical maximum values for solution gas and water drive. They assume that production is started at original reservoir pressure; i.e., no account is taken of production to date or of prior drainage to other areas. The effects of factors tending to reduce actual ultimate recovery, such as economic limits on oil production rates, gas-oil ratios, or water-oil ratios, have not been taken into account. Neither have factors been considered which may result in actual recovery intermediate between solution gas and complete water drive recoveries, such as gas cap expansion, gravity drainage, or partial water drive. Reasonable predictions of ultimate oil recovery to specific abandonment conditions may be made in an engineering study in which consideration is given to overall reservoir characteristics and economic factors.

These analyses, estimates and interpretations are based on observations and materials supplied by the client to whom, and for whose exclusive and confidential use, this report is made. The interpretations or opinions expressed represent the best judgment of Core Laboratories, Inc. (all covers and analysis contained) but Core Laboratories, Inc. and its officers and employees assume no responsibility and make no warranty or representation as to the productivity, better operation or profitability of any oil, gas or other mineral well or sand in connection with which such report is used or relied upon.



Wulf Oil Corporation

DAILY DRILLING REPORT

DATE: March 12, 1979 OPERATOR: Wulf Oil Corporation

WELL NAME AND LOCATION: #1 Peterson, T7S, R1E, Sec 21: NE1/4, Fall River Co., SD

DEPTH: 715'

BIT NUMBER: #1, Y12J, 7 7/8" Reed, drilled 750' with water, 5 hrs drilling cement & p

DRILLING MUD PROPERTIES: WT. _____ VIS. _____ PH _____ H₂O LOSS _____

SAMPLE TOPS:

REMARKS:

3-12

- 9 hrs - drilling new hole
- 8 hrs - nipple up
- 1/2 hrs - rig service
- 1/2 hrs - jetting pits
- 1 hrs - packing swivel

drilling 100 RPM's, 30,000 lbs weight, 54 strokes, 700 lbs pump pressure

35 total rotating hours

- 6 3/4 hrs - drilling
- 1 3/4 hrs - circulating
- 1/2 hrs - rig service
- 1/2 hrs - rig up casing tools
- 1/2 hrs - running casing
- 3/4 hrs - cementing
- 13 hrs - waiting on cement and nipple up

survey at 255' with 1° deviation

ran 245' of 8 5/8" 24 lbs ST&C

set at 253' Kb

cemented with 250 sacs cement, 3% Calcium Chloride and 1% chip seal

Good returns

- 4 hrs - work on derrick
- 5 hrs - drilling mouse and rat hole
- 15 hrs - drilling 12 1/2" hole

survey at 100' - 1° deviation

drill 100 RPM's, 5 1/2" liners, 14 x 54 strokes, 450 lbs pump pressure



Estimated spud date, March 1.

2-22-79 Grading location.

Expect to move in rotary tools by February 28.

Rig is currently under day work contract for the Federal Government at Phillip, South Dakota on a geothermal test.

March 2, 1979, 1:35 p.m.

Moved last load onto location this a.m.

Rig is on location and set in.

Shut down and recruiting crews.

When crews are hired, needed welding on derrick will begin.

Anticipate spudding Monday, March 5, 1979.

March 3, 1979 Hiring crews.

Crane or truck unavailable.

Anticipated spud date, Thursday, March 8, 1979

March 4, 1979 Hiring crews.

Crane or truck unavailable.

Anticipated spud date, Thursday, March 8, 1979

Working on derrick. Waiting on crane or truck to move derrick off of the floor.

March 6, 1979 Anticipated spud date March 8, 1979.

Working on derrick.

Anticipated spud date March 8, 1979.

March 7, 1979 Working on derrick.

Anticipated spud date March 8, 1979.

March 8, 1979 Derrick repaired and set up on drilling rig floor.

MIRT

March 9, 1979 Should spud late this afternoon.

Mixed mud and prepared to spud yesterday but derrick would not scope up due to damage incurred in transit to location. Will continue to repair derrick today. If you have further questions, please feel free to contact Joe Banks, Telephone (307) 682-9354.

RECEIVED
MAR 19 1979
131415

DRILLING REPORT

Crystal Oil Company
 AFE #80883
 Total Est Cost \$
 Crystal's Share \$100,650

Peterson #1
 Driftwood Prospect
 Fall River County, S. Dakota

LOCATION: NE/4, NE/4, Sec. 21, T7S, R1E
 PROPOSED TD: 2400'
 CONTRACTOR:
 ELEVATION:



- 3-10-79 TD 155', made 155', 1 day - - - This AM drilling - - - 4 hrs work on derrick, 5 hrs drill mouse & rathole, 15 hrs spud 12 1/4" hole. Survey 100', 1°.
- 3-11-79 TD 255', made 100', 2 days - - - This AM WOC & NU BOP's - - - 6 3/4 hrs drilling, 1 3/4 hrs circ, 1/4 hr rig service, 1/4 hr RU csg tools, 1 1/2 hrs run 8 5/8" 24# ST&C surface csg set at 253', cement w/250 sx + 3% CaCl + 1% chip seal, good returns, 3/4 hr cement, 13 hrs WOC & NU BOP's. Survey 255', 1°.
- 3-12-79 TD 750', made 495', 3 days - - - This AM drilling - - - drilling w/water - - - 5 hrs drill cement plug, 9 hrs drilling w/30,000#, 100 RPM, 700 pp, 8 hrs NU, 1 1/2 hrs rig service, 1 1/2 hrs jet pits, 1 hr pack swival - - - Bit #1, Y12J, in 255', made 495'.
- Crystal Oil assume operation 3-13-79.
- 3-13-79 TD 1476', made 734', 4 days - - - This AM drilling - - - drilling w/water - - - 1 1/4 hrs rig service, 1 1/2 hr survey, 1/2 hr rig repair, 4 1/2 hrs trip, 17 1/4 hrs drilling w/25,000#, 100 RPM, 650 pp - - - Bit #1, 7 7/8", Y12J, in 255', out 816', made 561' in 11 hrs. Bit #2, 7 7/8", Y12J, in 816', made 860' in 14 1/2 hrs. Survey 816', 1°.
- 3-14-79 TD 1721', made 245', sh, 5 days - - - This AM mudding up - - - Mud 9.2, Vis 46, WL 6.3 - - - 14 3/4 hrs drilling w/30,000#, 80 RPM, 650 pp, 1 1/4 hrs rig repair, 4 3/4 hrs work stuck pipe, ream 120' to btm, 1/4 hr service rig, 3 hrs mudding up & circ - - - Bit #2, 7 7/8", Y12J, in 816', made 905' in 29 1/4 hrs.
- 3-15-79 TD 1944', made 223', sd & sh, Minnelusa, 6 days - - - This AM work on mud pump - - - Mud 8.8, Vis 38, WL 12.6 - - - 4 1/2 hrs trip (1 hr pull 1st 3 stds, tight spot, 1/2 hr washing down), 1/2 hr survey, 1 1/2 hrs circ & cond, 1/2 hr service rig, 13 3/4 hrs drilling w/30,000#, 50 RPM, 550 pp, 3 1/4 hrs rig repair, work on mud pump - - - Bit #2, 7 7/8", Y12J, in 816', out 1721', made 905' in 29 1/4 hrs. Bit #3, 7 7/8", FP-52, in 1721', made 223' in 13 3/4 hrs. Survey 1721', 1 1/4°.
- 3-16-79 TD 2177', made 233', sd & sh, 7 days - - - This AM drilling - - - Mud 8.7, Vis 53, WL 6.6 - - - 3 1/4 hrs rig repair, 3/4 hrs service rig, 1 1/2 hrs circ & cond mud, 18 1/2 hrs drilling w/30,000#, 50 RPM, 500 pp - - - Bit #3, 7 7/8" FP-52, in 1721', made 456' in 32 1/4 hrs. Cum cost \$90,004.
- 3-17-79 TD 2266', made 109', sd & sh, 8 days - - - This AM drilling - - - Mud 10, Vis 64, WL 4.8 - - - 1 1/4 hrs service rig, 22 3/4 hrs drilling w/35,000#, 50 RPM, 600 pp - - - Bit #3, 7 7/8", FP-52, in 1721', made 565' in 55 hrs. Top of Red Marker 2270', Btm at 2278'. Cum cost \$98,664.



DRILLING REPORT (2)



CEPCO
AFE #80883
Total Est Cost \$
Crystal's Share \$100,650

Peterson #1
Driftwood Prospect
Fall River County, S. Dakota

3-18-79 TD 2378', made 92', sd & sh, 9 days - - - This AM trip to run core barrel - - - Mud 10, Vis 45, WL 4 - - - 21 3/4 hrs drilling w/35,000#, 50 RPM, 600 pp, 1/2 hr service rig, 1/4 hr rig repair, 1 1/2 hrs trip - - - Bit #3, 7 7/8", FP-52, in 1721', out 2378', made 657' in 76 3/4 hrs. Cum cost \$107,429.

3-19-79 TD 2395', made 17', sh & Leo sd, 10 days - - - This AM WOO, lay down core barrel - - - Mud 9.9, Vis 43, WL 8 - - - 4 hrs reaming, 13 hrs coring 2378-95', 5 hrs trip, cut 17', 1/4 hr survey, 1/4 hr RU to TOOH w/core, 1 1/2 hr break out & lay down core, show of sd on btm 8 1/2', Leo sd 2386.5-95', light to med gray, very, very fine grain, hard anhy, poor porosity & permeability. Survey 2378', 1 1/2°.

3-20-79 TD 2395', made 0', Leo Sd, 11 days - - - This AM wash core barrel to btm - - - Mud 9.7, Vis 51, WL 7.6 - - - 11 3/4 hrs trip, 3/4 hr ream, 4 1/2 hrs PU DST tool, run DST test #1, 15 mins, surface bubbles only, close tool 30 mins, reopen tool 60 mins, surface bubbles only, blow died in 52 mins, CI for 60 mins, POOH, CI pressures were higher than hydrostatic, tool slid 5' to btm, CI press appears to be of no value, mud may have been by passed or pkrs compressed rathole mud during CI, interval tested 2386-95', surface ck 1/4", btm ck 15/16", rec 50' drilling mud, Cal 300 PPM

1st Period: 2nd Period:
IHH 1165# IF ----
IF 17-23# FF 23-0#
IFF --- FCI ----
ICI --- FHH 1121#

Test not valid, 2 hrs circ & cond mud, 1/2 hr service rig, 4 1/2 hrs WOO, PU 60' core barrel, RIH at 7 AM, wash core barrel to btm. Cum cost \$124,415.

3-21-79 TD 2422', made 27', 2nd Leo Sd, 12 days - - - This AM lay down core - - - Mud 9.8, Vis 49, WL 5.8 - - - 3 1/2 hrs wash & ream 50' to btm, 1/2 hr circ & clean hole, 1 1/2 hr coring 2395-96', 1 hr go through pump, change fuel filters, 1/2 hr coring 2396-97', TOOH w/core #2 2385-97', 2 1/2 hrs TOOH & check core barrel, 1 1/2 hrs TIH w/core barrel, 1 1/2 hrs wash 4 jets to btm, 1 hr circ & cond mud, 3 hrs coring 2397-2422', 1/4 hr service rig, 2 1/2 hrs cond & circ mud, lay down kelly, 2 1/4 hrs TOOH w/core #3. Cum cost \$133,050.

3-22-79 TD 2434', made 12', 2nd Leo Sd & sh, 13 days - - - This AM POOH w/core #4 - - - Mud 10.5, Vis 48, WL 14 - - - 1 hr lay down core #3, cut 25', rec 18', 1 1/4 hrs WOO, 1/2 hr TIH to ream & cond core hole, 1 hr reaming core hole, 1 1/2 hrs circ & cond hole for core #4, 2 1/4 hrs TOOH, 1/2 hr service rig, 1/2 hr PU core barrel, 2 hrs TIH w/core barrel, 2 hrs reaming & circ, 8 1/2 hrs coring, 2422-34', 12', 1/4 hr service rig, 2 3/4 hrs circ & cond mud. Cum cost \$140,860.

3-23-79 TD 2500', made 66', sd, sh & dolomite, 14 days - - - This AM circ & cond to log - - - Mud 9.8, Vis 45, WL 8 - - - 2 1/2 hrs TOOH w/core #4, 2422-34', cut 12', 2 hrs lay down core & core barrel, rec 12', 1/2 hr service rig, 2 hrs TIH w/bit, 1/2 hr ream, 3/4 hr service rig, 14 1/2 hrs drilling, 1 1/4 hr circ & cond mud to log - - - Bit #3, 7 7/8", FP-52, RR, made 66' in 14 1/2 hrs. Cum cost \$150,853.

DRILLING REPORT
 (3)



CEPCO
 AFE #80883
 Total Est Cost \$
 Crystal's Share \$100,650

Peterson #1
 Driftwood Prospect
 Fall River County, S. Dakota

- 3-24-79 TD 2500', made 0', 15 days - - - This AM circ, prep to run csg - - - Mud 9.9, Vis 49 - - - 1/2 hr circ to log, 1/4 hr survey, 1 3/4 hrs TOOH to log, 10 hrs logging, Schlumberger ran DILL-SFL, bore hole compensated, sonic & dip meter, Schlumberger's TD 2499', driller's TD 2500', 1 1/2 hr TIH to circ, 11 hrs circ, WO csg. Survey 2500', 2°. Cum cost \$162,326.
- 3-25-79 TD 2500', made 0', 16 days - - - This AM WOC - - - 1 1/2 hr circ, WO csg, 3 1/2 hrs lay down kelly, DP, collars, RU csg crew, 3 hrs run 71 jts 5 1/2" 14# K-55 R-2 ST&C csg, test to 4300#, total 2503.94', land csg at 2499', PBD 2466', 3/4 hr RU Howco to cement, cement w/10 BW, 500 gals mud flush, 200 sx Class "G" cement, 3% KCL, .75% CFR-2, .4% Halad 22-A, .25 D-Air, displace w/61.13 2% KCL water, bump plug w/2000#, held 5 mins OK, plug down at 3:45 PM, broke out Howco, break down Hydri1 to set slips, 7 1/4 hrs well had strong water flow out csg, CI csg head, RD Howco, release rig at 11 PM, 3-24-79, 8 hrs WOC. Cum cost \$174,208.
- TD 2500', PBD 2466'.
- 3-26-79 24 hrs, waiting to move rig off location. Cum cost \$174,208.
- 3-27-79 RD & MO rig, WO completion rig. Cum cost \$174,208.
- 3-28-79 WO completion rig. Cum cost \$174,208.
- 3-29-79 11 hrs MI & RU Eatmon Rig #12 from Kimball, NB. Plan to run CBL & perforate today. Cum Cost \$186,208.
- 3-30-79 11 hrs, Schlumberger ran CBL-VDL-GR from 2450-1400', good bond to top of cement at 1530', found PBD at 2460', Howco press tested csg to 2500#, held OK, TIH w/4" csg gun, ~~test to 2400'~~ 400#, 4/SPF, FL at surface after perf, RIH w/tbg as follows:
- | | | |
|-----------------|---------------|-----------------------|
| Tbg breakdown: | | |
| 6.00' | | KB |
| 2342.51' | 75 jts | 2 7/8", 6.4# J-55 tbg |
| 1.12' | | 1 - SN |
| <u>2349.63'</u> | <u>75 jts</u> | |
- RIH w/swab, FL at surface, swab 3 hrs, rec 53 BLW, pulling from SN, fluid 100% load water, no gas, last run FL 100' above SN, 13 hrs CIFN. This AM CITP 5#, FL 1900', rec 300' dirty, brackish water, prep to acidize. Cum cost \$196,240.
- TD 2500', PBD 2460', 5 1/2" csg perfs 2399-2400'.
- 3-31-79 11 hrs, CITP 5#, CICP 5#, FL 1900', Halliburton acidized perfs 2399-2400' as follows: load hole w/36 bbls 2% KCL water, circ 12 bbls 15% HCL + 1%, displace w/3 bbls 2% KCL, CI csg w/1 bbl of acid across perfs, start pump on acid, break down formation at 600# at 1 BPM, 400# pp w/6 bbls of acid pump, SD, let acid soak 10 mins, press dropped to 0#, pump final 6 bbls acid at 2 BPM, 700# pp, overdisplace 1 bbl, ISIP 600#, 15 min 100#, RIH w/swab, FL at surface, swab 8 hrs, rec 157 bbls 100% water, swabbing from SN w/FL maintaining 400', average 19 BW per hr feed in after load rec, 13 hrs CIFN. This AM CITP 50#, CICP 50#, FL 200' from surface, bled off air (no gas) (no hydrocarbons). Cum cost \$201,218.

DRILLING REPORT
 (4)

CEPCO
 AFE #80883
 Total Est Cost \$
 Crystal's Share \$100,650

Peterson #1
 Driftwood Prospect
 Fall River County, S. Dakota

TD 2500', PBD 2460'.

- 4-1-79 10 hrs, CITP 50#, CICP 50#, bled off air (no gas), FL 200' from surface, fluid sample indicated 100% water, TOOH w/tbg, MU & TIH w/pkr & tbg, set pkr at 2290.53', WO Halliburton 4 hrs, mix & pump 25 sx Class "G" w/Halad 22-A, 75 sx Class "G" regular, 20 bbls slurry, sq perfs 2399-2400' at 2 BPM, 800# pp w/4 bbls in perfs, press increased to 1500#, reduce rate slowly from 2 BPM to 0 w/8 bbls in perfs, cement locked up, held 1500# on well for 30 mins w/ min bleed off, rev out cement, press up to 1500#, held 5 min, OK, POOH w/tbg, 14 hrs CIFN. This AM WOC. Cum cost \$208,452.
- 4-2-79 24 hrs WOC. This AM drill out cement sq. Cum cost \$208,452.
- 4-3-79 11 hrs, MU & TIH w/4 3/4" bit & scraper, 2 7/8" tbg, tag cement at 2348', RU power swival, rev circ equip, drill 50' cement, circ hole clean, test sq to 1500#, held OK, MU & TIH w/pkr, set at 2350', swab dry in 2 runs, no fluid entry, 13 hrs CIFN. This AM TOOH w/pkr, prep to perf 2400-02'. Cum cost \$210,442.
- 4-4-79 10 hrs, TP 0#, CP 0#, FL 2350', no fluid feed in, POOH w/tbg & pkr, RU Goodwill & perf 2400-02', 4/SPF, made 7 holes w/4" sag gun, 1 shot did not fire, found PBD 2424', RD Good will, TIH w/tbg & pkr as follows:

Tbg breakdown:		
6.00'		KB
2342.51'	75 jts	2 7/8" 6.4# J-55 tbg
1.12'		1 - SN
3.50'		1 - Baker Model "R" pkr
<u>2353.13'</u>	<u>75 jts</u>	

RU swab, swab well dry in 2 runs, made 1 run every 30 mins to 1 hr, rec 100' fluid per run, 100% water, no gas, cont to swab while WO Goodwill to reperfs, made 2 BW in 3 hrs swabbing, RU Goodwill, TIH w/ 1 11/16" through tbg gun, FL 200' above SN, perf 2400-02' w/9 holes, RD Goodwill, GIH w/ swab, found FL 200' above SN, swab dry, made 1 run every 30 mins, rec 50-100' fluid per run, 100% water, 14 hrs CIFN, rec 3 BW in 5 hrs swabbing. This AM opened tbg w/slight blow, no gas, CP 0#, FL 1000' from surface, 100% water, swab down in 1 run, FL maintaining 100' above SN, making 1 run every 30 mins. Cum cost \$213,732.





DRILLING REPORT
(5)

CEPCO
AFE #80863
Total Est Cost \$
Crystal's Share \$100,650

Peterson #1
Driftwood Prospect
Fall River County, S. Dakota

TD 2500', PBD 2460', 5 1/2" csg perfs 2400-02'.

4-7-79 12 hrs, work, 3 hrs WO Halliburton, RU, pump plug from 2424-2274' w/16 sx 50-50 Poz mix, lay down tbg, pump plug from 290-210' w/8 sx 50-50 Poz mix, filled top of 5 1/2" csg w/15' cement, pumped 10 sx cement into surface csg, RD Halliburton, RD Eatmon rig, load out pipe & clean up location.



P & A

FINAL REPORT



ADMINISTRATIVE / SUNDRY REPORTS



POWERTECH (USA) INC.

API ID 40 047 20074

27 of 48

SUNDRY NOTICES AND REPORT ON WELLS

FORM APPROVED
Budget Bureau No. 1004-0135
Expires: September 30, 1990

SUBMIT IN TRIPLICATE

1. Type of Well
 Oil Well Gas Well Other

2. Name of Operator
Crystal Oil Company

3. Address and Telephone No.
P.O. Box 21101, Shreveport, LA 71120 800-231-4814

4. Location of Well (Footage, Sec., T., R., M., or Survey Description)

NENE Sect. 21, T7S R1E
660' FNL & 758' FEL

5. Lease Designation and Serial No.

6. If Indian, Allottee or Tribe Name

7. If Unit or CA, Agreement Designation

8. Well Name and No.
Peterson #1

9. API Well No.
40-047-20074

10. Field and Pool, or Exploratory Area
Wildcat

11. County or Parish, State
Fall River, SD

12. CHECK APPROPRIATE BOX(S) TO INDICATE NATURE OF NOTICE, REPORT, OR OTHER DATA

TYPE OF SUBMISSION	TYPE OF ACTION
<input type="checkbox"/> Notice of Intent	<input checked="" type="checkbox"/> Abandonment
<input checked="" type="checkbox"/> Subsequent Report	<input type="checkbox"/> Recompletion
<input type="checkbox"/> Final Abandonment Notice	<input type="checkbox"/> Plugging Back
	<input type="checkbox"/> Casing Repair
	<input type="checkbox"/> Altering Casing
	<input type="checkbox"/> Other
	<input type="checkbox"/> Change of Plans
	<input type="checkbox"/> New Construction
	<input type="checkbox"/> Non-Routine Fracturing
	<input type="checkbox"/> Water Shut-Off
	<input type="checkbox"/> Conversion to Injection

(Note: Report results of multiple completion on Well Completion or Recompletion Report and Log form.)

13. Describe Proposed or Completed Operations (Clearly state all pertinent details, and give pertinent dates, including estimated date of starting any proposed work. If well is directionally drilled, give subsurface locations and measured and true vertical depths for all markers and zones pertinent to this work.)

8-31-95

Found fresh water leak to be in 5 1/2" csg.
 Tagged T.D. at 1800' with sand line.
 Welded a seal between 5 1/2" and 8 5/8" with an outlet in 8 5/8"
 Pump 50 sx class G. cement down 8 5/8" and shut in.
 Pump 50 sx cement in 5 1/2" from 370' to surface.
 Cement settled inside 5 1/2"
 Filled 5 1/2" back up with 20 sx
 Cement settled
 Wait 1 hour and filled 5 1/2" back up with 24 sx.
 Cement settled slowly.
 Wait 3 hours and filled 5 1/2" back up with 32 sx.
 5 1/2 and 8 5/8 stayed full.
 Welded a cap over the 8 5/8"
 Filled in holes and ditches and leveled location up.

RECEIVED

SEP 11 1995

OIL & GAS PROGRAM

14. I hereby certify that the foregoing is true and correct

Signed Edward Silts Title Foreman Date 9-7-95

(This space for Federal or State office use)

Approved by Fred H. Stone Title Well Site Supervisor Date SEP 11 1995

Conditions of approval, if any:

Title 18 U.S.C. Section 1001, makes it a crime for any person knowingly and willfully to make to any department or agency of the United States any false, fictitious or fraudulent statements or representations as to any matter within its jurisdiction.

*See instruction on Reverse Side



SUNDRY NOTICES AND REPORT ON WELLS

FORM APPROVED
 Budget Bureau No. 1004-0135
 Expires: September 30, 1990

5. Lease Designation and Serial No.

6. If Indian, Allotment or Tribe Name

7. If Unit or CA, Agreement Designation

8. Well Name and No.
 Peterson #1

9. API Well No.
 40-047-20074

10. Field and Pool, or Exploratory Area

11. County or Parish, State
 Wildcat
 Fall River, SD

SUBMIT IN TRIPLICATE

1. Type of Well
 Oil Well Gas Well Other

2. Name of Operator
 Crystal Oil Company

3. Address and Telephone No.
 P.O. Box 21101, Shreveport, LA 71120 800-231-4814

4. Location of Well (Fomage, Sec., T., R., M., or Survey Description)

NENE Sect. 21. T7S R1E
 660' FNL & 65B' FEL

12. CHECK APPROPRIATE BOX(es) TO INDICATE NATURE OF NOTICE, REPORT, OR OTHER DATA

TYPE OF SUBMISSION	TYPE OF ACTION
<input checked="" type="checkbox"/> Notice of Intent	<input checked="" type="checkbox"/> Abandonment
<input type="checkbox"/> Subsequent Report	<input type="checkbox"/> Recompletion
<input type="checkbox"/> Final Abandonment Notice	<input type="checkbox"/> Plugging Back
	<input type="checkbox"/> Casing Repair
	<input type="checkbox"/> Altering Casing
	<input type="checkbox"/> Other
	<input type="checkbox"/> Change of Plans
	<input type="checkbox"/> New Construction
	<input type="checkbox"/> Non-Routine Fracturing
	<input type="checkbox"/> Water Shut-Off
	<input type="checkbox"/> Conversion to Injection

(Note: Report results of multiple completion on Well Completion or Recompletion Report and Log form.)

13. Describe Proposed or Completed Operations (Clearly state all pertinent details, and give pertinent dates, including estimated date of starting any proposed work. If well is directionally drilled give subsurface locations and measured and true vertical depths for all markers and zones pertinent to this work.)

Repair a fresh water leak at the surface of the well which had been plugged on 4-6-79.

RIH with Tubing and Tag cement plug at 210'-290'
 If the plug is still there and is not leaking then perforate at 275' and set a cement retainer at 210' and squeeze the 8 5/8 with 100 sx of class G cement.
 Put a 15 sx plug at surface of 5 1/2.
 If the cement plug is not found at 210'-290' then replace it with 35 sx cement and 15 sx at surface of 5 1/2 plus pump 50 sx cement down the surface pipe.

14. I hereby certify that the foregoing is true and correct

Signed Edward Gibbs

Title Foreman UBI

Date 8-22-95

(This space for Federal or State office use)

Approved by _____
 Conditions of approval, if any:

Title _____

Date _____

Title 18 U.S.C. Section 1001, makes it a crime for any person knowingly and willfully in make to any department or agency of the United States any false, fictitious or fraudulent statements or representations in any manner within its jurisdiction.

*See instruction on Reverse Side



PLUGGING RECORD

Operator CRYSTAL OIL COMPANY		Address P. O. Box 21101, Shreveport, LA 71120		
Name of Lease Peterson		Well No. 1	Field & Reservoir Wildcat - Dry	
Location of Well 660' FNL & 658' FEL NE$\frac{1}{4}$, NE$\frac{1}{4}$ of Section 21, T7S, R1E		Sec-Twp-Rge or Block & Survey		County Fall River
Application to drill this well was filed in name of Wulf Oil Corporation	Has this well ever produced oil or gas No	Character of well at completion (Initial production): Oil (bbls/day) --- Gas (MCF/day) --- Dry? Yes		
Date plugged: April 6, 1979	Total depth 2500'	Amount well producing when plugged: Oil (bbls/day) 0 Gas (MCF/day) 0		Water (bbls./day) 0
Name of each formation containing oil or gas. Indicate which formation open to well bore at time of plugging: Dry		Fluid content of each formation ---	Depth interval of each formation ---	Size, kind & depth of plugs used indicate zones squeeze cemented, giving amount cement. ---

CASING RECORD

Size pipe	Put in well (ft.)	Pulled out (ft.)	Left in well (ft.)	Give depth and method of parting casing (shot ripped etc)	Packers and shoes
8-5/8"	253'	0	253'	---	None
5-1/2"	2499'	0	2499'	---	None

Was well filled with mud-laden fluid, according to regulations? **Yes**

Indicate deepest formation containing fresh water **Second Leo**

In addition to other information required on this form, if this well was plugged back for use as a fresh water well, give all pertinent details of plugging operations to base of fresh water sand, perforated interval to fresh water sand, name and address of surface owner, and attach letter from surface owner authorizing completion of this well as a water well and agreeing to assume full liability for any subsequent plugging which might be required.

4-6-79 - Pump plug from 2424-2274' w/16 sx 50-50 Posmix
Pump plug from 290-210' w/8 sx 50-50 Posmix
Pump plug from 15'-0' w/5 sx cement
Pump 10 sx cement into surface casing annulus.

Plugged and Abandoned 4-6-79



USE REVERSE SIDE FOR ADDITIONAL DETAIL

Executed this the **24** day of **April**, 19**79**
 State of **Louisiana**
 County of **Parish of Caddo**

Before me, the undersigned authority, on this day personally appeared **James O. Glass**, known to me to be the person whose name is subscribed to the above instrument, who being by me duly sworn on oath states, that he is duly authorized to make the above report and that he has knowledge of the facts stated therein, and that said report is true and correct.

Subscribed and sworn to before me this **24** day of **April**, 19**79**

SEAL
 My commission expires *with life*

Lillian Connor Nixon
 Notary Public in and for **LILLIAN CONNOR NIXON, Notary Public**
 Caddo Parish, Louisiana
 My Commission is For Life

Approved **May 8, 1979**
Date

DO NOT WRITE BELOW THIS LINE
 OIL AND GAS BOARD OF THE STATE OF SOUTH DAKOTA
Fred H. Steen
 Secretary

Supervisor, Western Field Office



Well name: Wulf #1 Abersom

CO: Fall River

Legal Location: NENE 21-75-2E

Status: 1st A

open hole size: 12 1/4
Depth: 253

surface csg size: 8 3/4
Depth: 253

Cement Amt: 250
calculations

- 1) RIT 5 1/2 - sandline to 100' no cement until started on obstruction
- 2) pumped 50 sks in 8 3/4 - 298.0
- 3) pumped 100 sks in 5 1/2 - 706.0

Formation Tops

2' Fin. Wulf 1A - 200' away

Dakota - 235

Clinton - 245

Basal Sandstone - 1153

1' 20' 1150 - 1170

Red shales - 2067

1' 6" 2060

2' 6" 2072

298 Open Hole size 7 7/8
2504 Depth

5 1/2 - 14 # production csg size & weight

Cement Amt; type: _____
calculations

$$Q = 106 \times 2 = 212$$

$$CRL = 10.0$$

1020

Pi A on 4/6/79

- 1) ...
- 2) ...
- 3) ...
- 4) ...

2397' 240' parts

2400' 240' parts

2400' 240' parts



**SUNDRY NOTICES AND
REPORT ON WELLS**

FARM OR LEASE NAME

Peterson

WELL NO.

1

FIELD AND POOL, OR WILDCAT

Wildcat

NO. ACRES IN LEASE

1200

SEC. TWP. RGE.

NE 1/4, NE 1/4

Sec. 21, T7S, R1E

COUNTY

Fall River

OIL WELL GAS WELL _____ DRY

OPERATOR

Crystal Oil Company

ADDRESS

P.O. Box 21101 -Shreveport, Louisiana 71120

LOCATION (In feet from nearest lines of section or legal subdivision, where possible)

660' FNL and 658' FEL of Sec. 21, T7S, R1E

ELEVATIONS (D.F., R.K.B., R.T., GRD., etc.; how determined)

3533' GR.

INDICATE BELOW BY CHECK MARK NATURE OF REPORT, NOTICE OR OTHER DATA

NOTICE OF INTENTION TO:

SUBSEQUENT REPORT OF:

TEST WATER SHUT-OFF

SHOOT OR ACIDIZE

WATER SHUT-OFF

SHOOTING OR ACIDIZING

FRACTURE TREAT

REPAIR WELL

FRACTURE TREATMENT

REPAIRING WELL

MULTIPLE COMPLETE

PULL OR ALTER CASING

ALTERING CASING

ABANDON

(Note: Report results of multiple completion on Well Completion or Recompletion and Log Form—Form 4)

DESCRIBE PROPOSED OR COMPLETED OPERATIONS (Clearly state all pertinent details, and give pertinent dates, including estimated date of starting any proposed work)

**4-6-79 Pump plug from 2424'-2274' w/16 sx 50-50 pozmix
Pump plug from 290'-210' w/8 sx 50-50 pozmix
Fill top of 5 1/2" casing w/15' cement, pump 10 sx cement in to surface casing.**



I hereby certify that the foregoing as to any work or operation performed is a true and correct report of such work or operation.

SIGNED

Robert O. Blase

TITLE

Asst. Mgr. of Prod. Admin.

DATE

4/9/79

DO NOT WRITE BELOW THIS LINE

Approved

4-17-79

Date

OIL AND GAS BOARD OF THE STATE OF SOUTH DAKOTA

Fred W. Steen
Supervisor, Western Field Office

CONDITIONS, IF ANY:

See Instructions On Reverse Side



CORRESPONDENCE

McGillivray, Mack

From: McGillivray, Mack
To: Steece, Fred; Townsend, Bob
Cc: Gledd, Roxanne; Hamann, Sheldon
Subject: RE: Leaking oil test well, Fall River County
Date: Tuesday, September 05, 1995 4:25PM

I witnessed the plugging of this well last Thurs (8/31). When I arrived on location a backhoe had finished digging down to the casing. Water was shooting out of the weld around the cap on the surface (8 5/8") casing. The welder welded a 2" collar on the side of the surface pipe and cut a hole through the pipe. I estimated the flow at about 20 gpm. When the welder cut off the old casing cap, it was apparent the flow was coming up the inside of the production (5 1/2") casing, not the production/surface casing annulus as we had expected. This led us to speculate that the 5 1/2 had holes in it somewhere. Since the rig only had 400' of tubing, I had the rig run their sand line with a large sinker bar into the hole to determine where the top cement plug was. They didn't hit anything until 1800'; there was supposed to be cement plugs at the surface and at 210-290'.

A ring was welded in the annulus to isolate the two strings of casing, and a vacuum truck pumped up the water flowing out of the casing. A line from the cement pump was hooked up to the 8 5/8 casing, and we pumped 50 sacks of cement down the casing at 2 bpm - 400 psi, leaving a plug from 295-0'. There was still 300 psi when we stopped pumping, so we shut the valve, and left the pressure on the pipe. The flow from the 5 1/2 never changed.

The rig ran 12 jts of 2 3/8" tubing into the 5 1/2 casing to 399', and we pumped a 50 sk plug from 419-0' (base of surface cag - 385'). When the tubing was pulled out, the cement level dropped about 100' in the pipe, but the water flow had stopped completely. I had them shut down for 1 hour, then we pumped 20 more sks cmt. The cement level dropped again, to the 100' level. I told them I wanted to see the cement level stay at surface, so we released the rig and waited 3 hours for the cement to set up. After 3 hours, we pumped another 35 sks cmt to fill the pipe. This time, the cement level stayed static. A total of 105 sks cmt were pumped down the 5 1/2 cag, which calculates to a plug from 768' to surface.

A steel cap was welded on top of the pipe, and the backhoe filled the hole and levelled the location. Wayne Peterson (the landowner), stopped by and said he was pleased with the response, cooperation, and results from Crystal Oil Co. and DENR.

As a side note, I witnessed another plugging of a former producing well the day before south of Provo. The company rep spent most of the time informing me SD plugging regs were too strict and expensive, and we were killing future exploration in the state. He asked why we required so much cement in shallow wells. I invited him to ride with me the next day to this well, and I would show him why.

From: Steece, Fred
To: Townsend, Bob
Cc: McGillivray, Mack
Subject: Leaking oil test well, Fall River County
Date: Wednesday, June 07, 1995 10:49AM

Bob, I received a fax from Crystal Oil Co. this morning that they are talking with Updike Brothers, Inc., a drilling contractor in Newcastle, WY, and have asked for Updike to submit a bid on repairing the well.

**Steece, Fred**

From: Townsend, Bob
To: Merkley, Bill; Goodman, Jim; Tollefsrud, Tim
Cc: Pirner, Steve; Steece, Fred
Subject: FW: Mail failure
Date: Friday, June 02, 1995 9:54AM

I discussed this with Fred this morning. The leakage rate was estimated by Meck at about 10 gpm. The leakage is probably related to a problem with cementing in the annulus between the surface casing and long string. Fred has been in contact with the company that did the test several times and has faxed well information to them in that they no longer have records on this well. Fred indicates that they plan to fix the well although they don't have a time line for the fix yet because they are still evaluating the information Fred sent. If the company does not respond with a plan in the next week or two, Fred will write them a letter requesting a plan for fixing the well.

Microsoft Mail v3.0 IPM.Microsoft Mail.Note

From: Steece, Fred
To: Townsend, Bob
Cc: Gledd, Roxanne
McGillivray, Meck
Subject: 1979 oil test leaking water, Fall River County
Date: 1995-06-01 10:48
Priority:
Message ID: 534D4BE1
Conversation ID: 534D4BE1

Bob, this note is for your information.

Mr. Wayne Peterson, a rancher in Fall River County informed us that an oil test drilled on his land in 1979 has started to leak water for the past several months. Meck and Mr. Peterson inspected the site on Tuesday and found the well to be flowing maybe 10 gpm. The water is being diverted from his hay field onto the Cheyenne River flood plain where it is being dissipated into the alluvium. I talked to Roxanne who told me that even though the operator's drilling bond has long since been released, they would still have some responsibility to fix the problem. I phoned the operator, located in Louisiana, and was told they would repair the well at an early date.



**DEPARTMENT of ENVIRONMENT
and NATURAL RESOURCES**
OIL AND GAS PROGRAM
2050 West Main, Suite #1
Rapid City, SD 57702
605-394-2229 FAX 605-394-5317

TO: WFO Files
FROM: Fred V. Steece
DATE: June 2, 1995
SUBJECT: Leaking oil test, Fall River County

This office was contacted by Mr. Mark Tubbs for Mr. Wayne Peterson on ~~or about May 29,~~ ^{May 22} 1995 informing Mack that an old oil test drilled on Peterson's land had begun to flow water several months ago. The Wulf #1 Peterson located in NENE 21-7S-1E, Fall River County, was started by Wulf, taken over and plugged by Crystal Oil Company in 1979.

The following day Mack McGillivray met Mr. Peterson and inspected the well location and took photos and kept notes on his findings. He found that the water was flowing at an estimated rate of 10 gpm and had been channelled away from a hayfield toward the Cheyenne River. The water was not entering the river but was disappearing into the alluvium some distance from the river.

I spoke to Roxanne Giedd, Assistant Attorney General, to find out what responsibility the company would have after all this time, particularly since their drilling and plugging bond had long since been released. Roxanne told me as long as the well was not completed as a water well and turned over to the landowner for his use that, the company would still be responsible for plugging the hole.

I next visited with Jim Goodman at Water Rights to inform him of the flowing well and to inquire whether his division had a fund for plugging uncontrolled wells. He informed me they did not.

On June 1, 1995, I telephoned the company in Shreveport, LA and spoke with Mr. Sam Clinton who assured me that Crystal is a responsible company and would fix the problem. He arranged for Mr. Pat Eddings to contact me and we spoke about details of information in our well files. I faxed the information that he requested, including a list of drilling contractors who have drilled in South Dakota in recent times. Mr. Eddings said he would study the information and get back to me when they had made a decision on the well.

I conveyed some of this information to Bob Townsend via E-Mail dated June 2, 1995.



MCM STOCK TRANSFER COMPANY, INC.

"STOCK TRANSFER & REGISTRAR SERVICES"

MICHAEL C. MILLER
PRESIDENT

(303) 860-7842

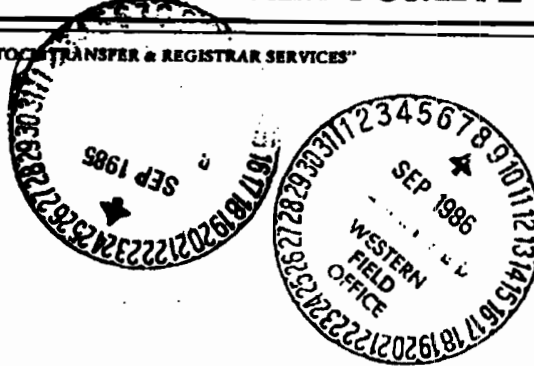

September 2, 1986

Mr. Fred Steece, Supervisor
Department of Water & Natural Resources
Western Field Office
36 E. Chicago
Rapid City, South Dakota 57701

Re: Letter of 06/09/86
Wulf Oil Corporation

Dear Mr. Steece:

As per requested in your letter of June 9, 1986, in regard to the Wulf #1 Peterson well and the Wulf #4 Federal well in Fall River County, South Dakota, I have sent you the material I found in the company files. The Wulf #1 Peterson was operated by Crystal Oil, who took over in the middle of the drilling of it. Any further information you need on this, I would suggest you contact them.

- The information I am sending includes this:
- (1) Geological Report Wulf Oil #4 Federal
 - (2) Plugging Record Wulf Peterson #1
 - (3) Drilling Report Wulf #1 Peterson

I received copies of the above from Banks Enterprises, Inc., one of the partners on the projects. Most of our records were lost in

Yours very truly,

Larry C. Wulf, President
WULF OIL CORPORATION

LCW/lw
Enc: 1

MAILING ADDRESS: P.O. BOX 30017, DENVER, CO 80231
OFFICE ADDRESS: 901 EAST 17th AVENUE, SUITE 200, DENVER, CO 80202

Mr. Fred V. Steece, Supervisor
Western Field Office
36 East Chicago
Rapid City, SD 57701

Dear Mr. Steece:

This letter informs you that the surface restoration
at the site of the following oil or gas test well
has been completed to my satisfaction.

<u>Permit</u>	<u>Well Name and Location</u>
903	Wulf #1 Peterson, NENE 21-7S-1E, Fall River

I am the surface owner of record.

SIGNED Wayne J. Peterson DATE 9/19/85



CRYSTAL

OIL COMPANY

SUITE 879, TOWER III, PARK CENTRAL BUILDING
1515 ARAPAHOE ST., DENVER, COLORADO 80202
TELEPHONE 303-623-2228

April 10, 1979

Department of Natural Resources
South Dakota Geological Survey
Western Field Office
308 West Boulevard
Rapid City, South Dakota 57701

Attention: Fred V. Steece

Re: Crystal No. 1 Peterson
NE/4NE/4 Section 21
Township 1 East, Range 7 South
Fall River County, South Dakota



Gentlemen:

This is to advise I do not want a dry hole marker locating the Crystal No. 1 Peterson erected in my cultivated field because of a hindrance to my future farming of same. Thank you.

Very truly yours,

PETERSON AND SONS, INC.

By: Wayne J. Peterson
P. Inc.

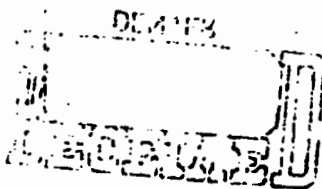



CRYSTAL OIL COMPANY

P.O. BOX 21101, SHREVEPORT, LOUISIANA 71120
TELEPHONE 318-222-7781 TWX 510 973 4087

March 13, 1979

South Dakota
State Geological Survey
308 West Boulevard
Rapid City, South Dakota 57701

Re: Transfer of Drilling Permit
Wulf Oil Corp.-Paterson #1
Permit no. 903

Gentlemen:

We acquired the above well March 13, 1979 and assume the full responsibility for its operation and abandonment in conformity with the law, rules, regulations, and orders issued by the board.

A Blanket Bond in our name is attached.

If there is any other information we should furnish you, please let us know.

Yours very truly,

CRYSTAL OIL COMPANY

Asst. Manager of Production Admin.

JOG/mr

Attachments





SURETY



NOV 30 1978

State Pub. Co., Pierre

S. Dak. Oil & Gas Board
FORM 8

Bond No. 708E675-4

BOND

KNOW ALL MEN BY THESE PRESENTS,

That
we: Hulf Oil Corporation
of the _____ in the _____
County of: Dawes State of: Nebraska
as Principal,
and Travelers Indemnity Company
of Hartford, Connecticut

As surety, authorized to do business in the State of South Dakota as surety, are held and firmly bound unto the State of South Dakota in the sum of (\$4,000.00; \$20,000.00), lawful money of the United States, for which payment, well and truly to be made, we bind ourselves, and each of us, and each of our heirs, executors, administrators or successors, and assigns jointly and severally, firmly by these presents.

The condition of this obligation is that whereas the above bounden principal proposes to drill a well or wells for oil, gas, or stratigraphic purposes in and upon the following described land situated within the State, to wit:

Blanket

(May be used as blanket bond or for single well)

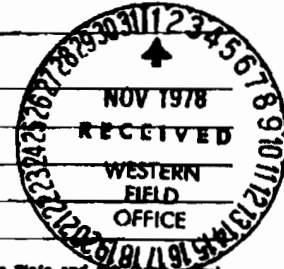

NOW, THEREFORE, if the above bounden principal shall comply with all of the provisions of the laws of this State and the regulations and orders of the Oil and Gas Board of the State, especially with reference to the proper plugging of said well or wells, and filing with the Oil and Gas Board of this State all notices and records required by said Board, and the restoration of the surface, in the event said well or wells do not produce oil or gas in commercial quantities, or cease to produce oil or gas in commercial quantities, then this obligation shall be terminated by the Board, the same shall be and remain in full force and effect.

Final sum of

Twenty Thousand Dollars and no/100----- (\$20,000.00)

Witness our hands and seals, this 25th day of October 1978

Hulf Oil Corporation

Dennis R. Steel
Vice President

Principal

Witness our hands and seals, this 25th day of October 1978

Countersignature:

Charles J. Nease

Travelers Indemnity Company

Norman Sterling, Jr.

Norman Sterling, Jr., Attorney-in-fact

(If the principal is a corporation, the bond should be executed by its duly authorized officers, with the seal of the corporation affixed. When principal or surety executes this bond by agent, power of attorney or other evidence of authority must accompany the bond.)

DO NOT WRITE BELOW THIS LINE

Approved 11-1-78
Date

OIL AND GAS BOARD OF THE STATE OF SOUTH DAKOTA
Fred V. Steele
Secretary
Supervisor, Western Field Office



Bond No. 708E1254



STATE OF SOUTH DAKOTA

Department of Natural Resource Development Division of Geological Survey Form 8

BONDING COMPANY INFORMATION SHEET

Information about your bonding company:

Name of bonding company: Travelers Indemnity Company
Street Address: 101 University Blvd.
City, State: Denver, CO 80206
Phone: (303) 321-2333 Remarks:

Information about your South Dakota bonding company agent:

Name of South Dakota Agent: Kluthe & Land Agency
Street Address: 619 Mount Rushmore Rd., P.O. Box 3031
City, State: Rapid City, South Dakota 57701
Phone: Remarks:

Information about releasing your bond:

When the Principal for whom you are providing Surety has fulfilled all obligations, whom should we contact with our Bond Release?

Name of Contact: Bayly, Martin & Pay, Inc.
Street Address: 817 17th Street, Suite 500
City, State: Denver, Colorado 80202
Phone: (303) 292-500 Remarks:

Please file this form together with Oil & Gas Form No. 3 with: Mr. Fred V. Steece, Supervisor, South Dakota Geological Survey, Western Field Office, 308 West Boulevard, Rapid City, South Dakota 57701 PH: (605) 394-2229

The Travelers Indemnity Company
Hartford, Connecticut
POWER OF ATTORNEY



KNOW ALL MEN BY THESE PRESENTS:

That THE TRAVELERS INDEMNITY COMPANY, a corporation of the State of Connecticut does hereby make, constitute and appoint

Norman Sterling, Jr., Paul M. Barbour, Norman C. Headrick, David H. Snead, Thomas J. Sisk, Jr., all of Denver, Colorado, EACH

its true and lawful Attorney(s)-in-Fact, with full power and authority, for and on behalf of the Company as surety, to execute and deliver and affix the seal of the Company thereto, if a seal is required, bonds, undertakings, recognizances, consents of surety or other written obligations in the nature thereof, as follows:

Any and all bonds, undertakings, recognizances, consents of surety or other written obligations in the nature thereof not exceeding in amount Two Hundred Thousand Dollars (\$200,000) in any single instance

and to bind THE TRAVELERS INDEMNITY COMPANY thereby, and all of the acts of said Attorney(s)-in-Fact, pursuant to these presents, are hereby ratified and confirmed. This appointment is made under and by authority of the following by-laws of the Company which by-laws are now in full force and effect:

ARTICLE IV, SECTION 14. The Chairman of the Board, the President, the Chairman of the Finance Committee, any Executive Vice President, any Senior Vice President, any Vice President, any Second Vice President, the Corporate Secretary or any Department Secretary may appoint attorneys-in-fact or agents with power and authority, as defined or limited in their respective powers of attorney, for and on behalf of the Company to execute and deliver, and affix the seal of the Company thereto, bonds, undertakings, recognizances, consents of surety or other written obligations in the nature thereof and any of said officers may remove any such attorney-in-fact or agent and revoke the power and authority given to him.

ARTICLE IV, SECTION 16. Any bond, undertaking, recognizance, consent of surety or written obligation in the nature thereof shall be valid and binding upon the Company when signed by the Chairman of the Board, the President, the Chairman of the Finance Committee, any Executive Vice President, any Senior Vice President, any Vice President or any Second Vice President and duly attested and sealed, if a seal is required, by the Corporate Secretary or any Department Secretary or any Assistant Corporate Secretary or any Assistant Department Secretary, or shall be valid and binding upon the Company when duly executed and sealed, if a seal is required, by a duly authorized attorney-in-fact or agent, pursuant to and within the limits of the authority granted by his or her power of attorney.

This power of attorney is signed and sealed by facsimile under and by the authority of the following Resolution adopted by the Directors of THE TRAVELERS INDEMNITY COMPANY at a meeting duly called and held on the 30th day of November, 1959:

VERSED: That the signature of any officer authorized by the By-Laws and the Company seal may be affixed by facsimile to any power of attorney or special power of attorney or certification of either given for the execution of any bond, undertaking, recognizance or other written obligation in the nature thereof; such signature and seal, when so used being hereby adopted by the Company as the original signature of such officer and the original seal of the Company, to be valid and binding upon the Company with the same force and effect as though manually affixed.

This power of attorney revokes that dated October 20, 1976 on behalf of Norman Sterling, Jr., Schuyler F. Cross, Paul M. Barbour

IN WITNESS WHEREOF, THE TRAVELERS INDEMNITY COMPANY has caused these presents to be signed by its proper officer and its corporate seal to be hereunto affixed this 30th day of May 1978.



THE TRAVELERS INDEMNITY COMPANY

By

[Handwritten signature]

Secretary, Surety

State of Connecticut, County of Hartford—ss:

On this 30th day of May in the year 1978 before me personally came D. J. Nash to me known, who, being by me duly sworn, did depose and say: that he resides in the State of Connecticut; that he is Secretary (Surety) of THE TRAVELERS INDEMNITY COMPANY, the corporation described in and which executed the above instrument; that he knows the seal of said corporation; that the seal affixed to said instrument is such corporate seal; that it was so affixed by authority of his office under the by-laws of said corporation, and that he signed his name thereto by like authority.



[Handwritten signature of Gloria R. Stevens]

Notary Public

My commission expires April 1, 1983

MISCELLANEOUS



**NO MISCELLANEOUS
INFORMATION FOR THIS WELL
AS OF 5/18/2011**



Oil and Gas Search for: api_no_like '40 047 20077'		
Page 1 of 1	<u>Download Database</u> (Excel spreadsheet format)	Page: Prev 1 <input type="button" value="v"/> Next

Record 1 of 1

Well Information

API No:	40 047 20077	County:	FALL RIVER
Well Name:	WULF 2 PETERSON	Location:	SWSW 15-7S-1E
Permit No:	919	Total Depth:	2462
Operator Name:	WULF OIL CORPORATION	Bottom Hole:	Minnelusa
Permit Date:	06-08-1979	KB Elevation:	3572
Spud Date:	08-03-1979	Ground Elevation:	3564
Plug Date:	08-13-1979	Latitude:	43.435870
		Longitude:	-103.991583
Well Field	WILDCAT	Status	P&A
Class:	DRY HOLE	Type:	DRY HOLE

Formation Tops

<u>Formation</u>	<u>Depth (ft.)</u>
Sundance	822
Spearfish	1164
Goose Egg	1515
Minnekahta	1689
Opeche	1728
Minnelusa	1817
Red Marker	2232
1st Leo	2242
2nd Leo	2349

Page 1 of 1 (goto top)	Page: Prev 1 <input type="button" value="v"/> Next
-------------------------------	--

COUNTY: FALL RIVER
LEGAL LOCATION: SWSW 15-7N-1E
API NO: 40 047 20077
PERMIT NO: 919
WELL NAME: WULF #1 PETERSON
OPERATOR: WULF OIL CORPORATION
PERMIT ISSUED: 06/08/1979
PERMIT CLOSED: 09/21/1979
FILE LOCATION: 7N-1E-15 SWSW

TARGET CODES:

WELL HISTORY / CHECKLIST

PERMIT TO DRILL / INTENT TO DRILL

WELL INSPECTION / SCOUT REPORTS

OPERATOR'S TECHNICAL REPORTS / MAPS

ADMINISTRATIVE / SUNDRY REPORTS

CORRESPONDENCE

SURETY

MISCELLANEOUS

WELL HISTORY / CHECKLIST



BOND RELEASE CHECKLIST

Well Name and Location		Permit # <u>919</u>
Wulf #2 Peterson SWSW 15-7S-1E, Fall River		API # <u>40 063 20077</u>
Bond # <u>708E675-4</u>	Date Issued _____	Date Released <u>NOV 06 1985</u>

Surface Restoration

- Pits filled
- Site Level
- Site policed
- Dry-hole marker solid, sealed, correctly inscribed
- ~~NA~~ No dry-hole marker desired, letter in WFO files from surface owner
- Letter from surface owner

Paperwork filed

- Form 4 (Completion or Recompletion Report)
- Form 6 (Sundry Notice and Report on Wells)
- Form 7 (Plugging Report)

Geological Information Filed

- Well Logs: IES, SNP, DIL, GR, NEUT, CALIP, Cement Bond, Temp, Micro, Laterlog, SM Dens. Acoustilog
- DST Charts and Reports
- Geologist's Report
- Results of coring and core analyses (*None cut*)
- Set of 10-foot sample cuttings (Check with Bob Schoon)

Date NOV 1 1985 Checked By J. Stace

PERMIT CHECKLIST

Well Name and Location:	Permit # 919
Wulf #2 Peterson SWSW 15-7S-1E, Fall River	API # 40 047 20077
	BOND # 708E675-4

Paperwork filed with WFO

- Organization Report
- Application
- Bond
- Permit Fee

The Following Papers sent to Operator:

- Permit (Form 2a)
- Receipt for \$100 permit fee
- Cover letter explaining material sent

Permit Fee Filed:

- Permit fee w/Cash Receipts Transmittal Form sent to State Treasurer

Notification of New Permit sent to:

- Dr. Duncan J. McGregor
- ~~Mr. Warren R. Neufeld~~ Mr. Warren R. Neufeld
- ~~Mr. Jack Gerken~~
- ~~Mr. Jack Gerken~~ Mr. Jack Gerken

Date June 22, 1979 Check By cp



PERMIT TO DRILL / INTENT TO DRILL

State Pub. Co., Pierre

APPLICATION FOR PERMIT TO:

S Dak Oil & Gas Board
FORM 2

<input checked="" type="checkbox"/> DRILL	<input type="checkbox"/> DEEPEN	<input type="checkbox"/> PLUG BACK	FARM OR LEASE NAME Peterson
<input checked="" type="checkbox"/> OIL WELL	<input type="checkbox"/> GAS WELL	<input checked="" type="checkbox"/> SINGLE ZONE	WELL NO. #2
OPERATOR Wulf Oil Corporation			FIELD AND POOL OR WILDCAT Wildcat
ADDRESS P.O. Box 1320, Chadron, NE 69337			NO. ACRES IN LEASE 1200.00
LOCATION (in feet from nearest lines of section or legal subdivision, where possible)* 1/330' FSL - 987' FWL Section 15			1/4 SEC. TWP. RGE Sec 15: T7S, R1E Center SE 1/4 SW 1/4 SW 1/4 COUNTY Fall River, South Dakota
NAME AND ADDRESS OF SURFACE OWNER Peterson & Son, Inc. Edgemont, South Dakota HCR - 59, Box 16		ELEVATION 3564.9' gr PROPOSED DEPTH 2400'	NO. OF WELLS ETC 1 ROTARY OR CABLE TOOLS Rotary
NAME AND ADDRESS OF CONTRACTOR Northern Wyoming Drilling Co., Inc. P.O. Box 487 Gillette, Wyoming 82716		APPROXIMATE DATE WORK WILL START July 1, 1979	
IF LEASE PURCHASED WITH ANY WELLS DRILLED, FROM WHOM PURCHASED (Name and address) NA			

PROPOSED CASING AND CEMENTING PROGRAM

SIZE OF HOLE	SIZE OF CASING	WEIGHT PER FOOT	NEW OR SECOND HAND	DEPTH	SACKS OF CEMENT
12 1/4"	8 5/8"	24#	New	250'	200 sx.
7 7/8"	5 1/2"	15.50#	New	2,400'	150 sx.

DESCRIBE PROPOSED OPERATIONS. IF PROPOSAL IS TO DEEPEN OR PLUG BACK, GIVE DATA ON PRESENT PRODUCTIVE ZONE AND PROPOSED NEW PRODUCTIVE ZONE. GIVE BLOW OUT PREVENTER PROGRAM IF ANY

We plan to drill a 2,400' well into the Leo Formation. We plan to start the well July 1, 1979 with operations lasting approximately 14 days.

Northern Wyoming Drilling Rig #2 is equipped with a 10" Ragan Blowout Preventor which will be used while drilling the well.

SIGNED Dennis R. Staal Operator President DATE 5 15 79

PERMIT NO. 919
 PERMIT NO. _____
 APPROVAL DATE 6-8-79
 DAY: 15 MONTH: 15
 CONDITIONS:
 COMPLETE SET OF SAMPLES, AND CORES IF TAKEN, MUST BE SUBMITTED.
 SAMPLES, AND CORES IF TAKEN, BELOW _____ DEPTH, MUST BE SUBMITTED.
SOUTH DAKOTA
STATE GEOLOGICAL SURVEY
WESTERN FIELD OFFICE

NOT WRITE BELOW THIS LINE
 CHECKED BY Fred A. Steere
 School and Public Lands Secretary



API ID 40 047 20077 JUN 27 1979
PLAINS ENGINEERING
 Consulting Engineers & Land Surveyors

NEWCASTLE
 P. O. BOX 777
 NEWCASTLE, WYOMING 82701
 PHONE 307-746-2724
 HOT SPRINGS
 CITY HALL
 HOT SPRINGS, SOUTH DAKOTA 57747
 PHONE 605-745-5000

GILLETTE
 BOX 117
 GILLETTE, WYOMING 82716
 PHONE 307-688-7800
 BUFFALO
 P. O. BOX 428
 BUFFALO, WYOMING 82834
 PHONE 307-684-7976

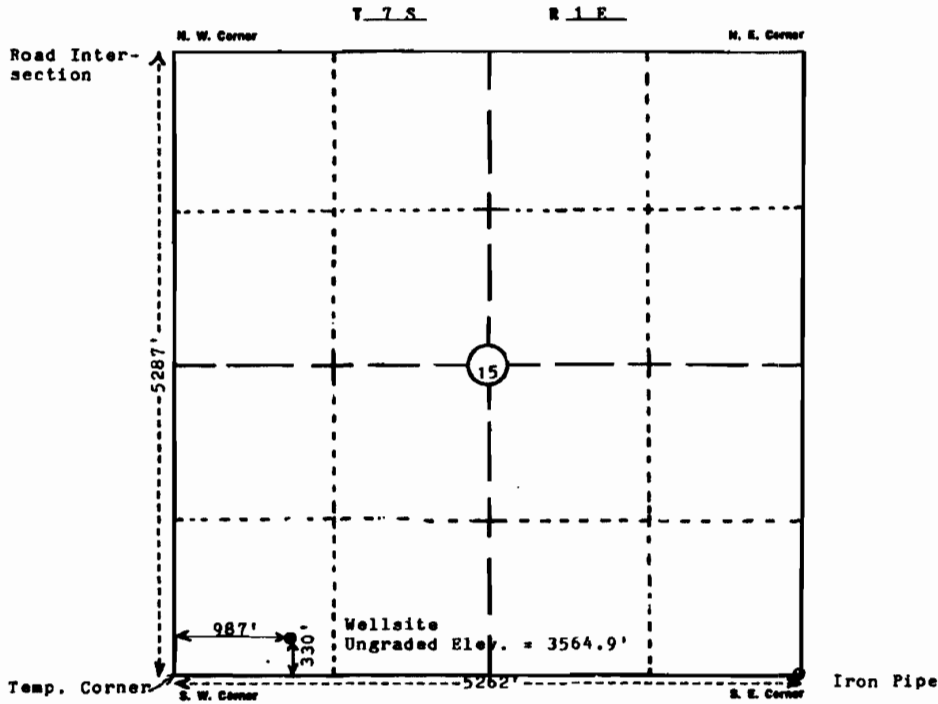

Dry Hole Site - NE $\frac{1}{4}$ NE $\frac{1}{4}$ Section 21 - Elev.=3536.5'
 Water Well - SW $\frac{1}{4}$ NW $\frac{1}{4}$ Section 22 - Elev.=3532.5'

I, Darrel L. Schlup, of Newcastle, Wyoming, certify
 that in accordance with a request from Jim Cox
 of Chadron, Nebraska, for Wulf Oil Corp.
P. O. Box 1320, Chadron, Nebraska 69337

That I ~~XXXXXXXXXX~~
 made a survey (date) May 8 1979
 for the location and elevation Wellsite

As shown on above map, the wellsite is in Center SE $\frac{1}{4}$ SW $\frac{1}{4}$ SW $\frac{1}{4}$
 Section 15, Township 7 South, Range 1 East W~~8~~
Fall River County, So. Dak. Elevation is 3564.9 feet
 above mean sea level before dozing.

Darrel L. Schlup
 Licensed Surveyor No. 545

Notes Attached
 NW 799003.29



WELL INSPECTION / SCOUT REPORTS

SOUTH DAKOTA GEOLOGICAL SURVEY
Western Field Office

SCOUT REPORT

Number 2-3

Date Scouted 8-12-79

Operator WLF

Permit Number 11

Farm/Lease Name #2 Peterson

APN number 57 2077

SW38 Sec. 15 T. 7C R. 1E

County Hall River

Elev. 3000 Est. T.D. 2400 Actual T.D. 2462 Spudded _____

Contractor Northern Wyo. Drilling Geologist Dr. Gries

SCOUT'S OBSERVATION:

DST RECORD:

Drilling at 1530, expect TD in 3 days - move out on Friday, 8-17.
8-12-79: Logger was broken down but is now fixed. Couldn't get all the way down the hole. Contractor plans to trip in and condition and then try logging again, will plug sometime tomorrow. Had fresh water flow from Lakota.

FORMATION TOPS:

8/12-13/79: Plugged, no problems. *J*

8-21-79: Dry hole marker solid, sealed, properly labeled. Two baskets of pipe are still at the site. The pits are open and not fenced and there is assorted junk lying around. Mouse, rat holes still open. Site not approved. *W*

J 10-6-79: Pits are filled, site is clean, level. Not seeded. Site approved.

PLUGGING RECORD:

DATE PLUGGED: ~~COMPLETLY~~ 8/12-13/79

10 sax - 0' - surface
60 sax - 682' - Top Morrison - BS
25 sax - 1922' - Minnelusa
25 sax - 2232' - Red Marker

CASING RECORD:

SITE INSPECTION:

0 5/2 From 0 To 500

Approved X

From _____ To _____

Not Approved _____

REMARKS:

SCOUTED BY Tim Kenyon
Tim Kenyon
Geologic Assistant

Fred V. Steece
Fred V. Steece, Supervisor
Western Field Office

WULF # 2 PETERSON

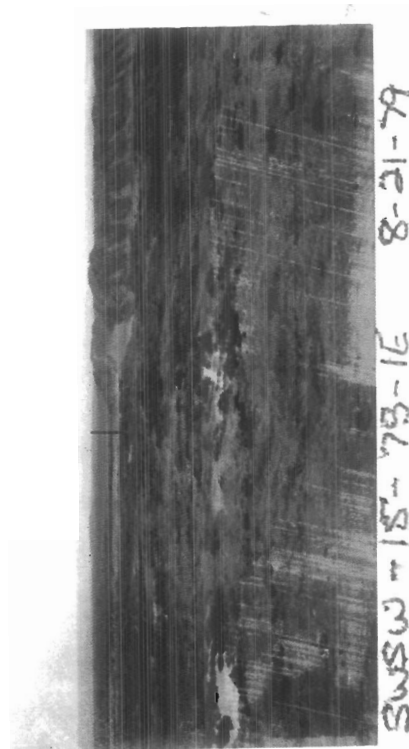

OPERATOR'S TECHNICAL REPORTS / MAPS



DRILLING LOG

PROPERTIES: WT. _____ VIS. _____ PH _____ H₂O LOSS _____

SAMPLE TOPS:

REMARKS:

Finished RURT & Spudded at 7:00 P.M.
August 4, 1979

Drilling rat and mouse hole

August 5, 1979

7:00 A.M. — Tripping

drilled 600' of 12 1/2" hole

- 2 hrs — rat hole
- 3 hrs — trip
- 18 1/2 hrs — drill
- 1/2 hrs — rig service

Surveys at — 250' with 1° deviation
600' with 3/4° deviation

August 6, 1979

7:00 A.M. nipping up

- 1/2 hr — circulating
- 1 hr — trip out
- 2 hr — rig up & run casing
- 2 hr — cementing
- 12 hr — waiting on cement
- 6 1/2 hr — nipping up

ran 13 joints of 8 5/8", 24 lbs. ST & C
588' set at 596' KB
plugged down at 11:00 A.M. with good returns

water flow in Lakota at 500', strong 3 inch, improving

225 sacs lite cement with 3% calcium chloride and 1% chip plug followed by
175 sacs regular cement with 3% calcium chloride and 1% chip load.

August 7, 1979

3 days since spud
7 days since move

drilling with water

surface bit — 12 1/2" Y-12-J — drilled 600' in 20 hrs.

bit #1 — 7 7/8" Y-12-J, in at 600', drilled 820' in 17 3/4 hrs.

- 1/2 hrs — rig service
- 17 3/4 hrs — drilling
- 2 hrs drilling cement
- 1 hrs redrill mouse hole
- 3 hrs finish nipping up

131



8-8

4 days since spud
 drilled 495' in 24 hrs
 present operation — drilling
 drilling in shale
 total rotating hrs. - 56 3/4 hrs
 drilling with water
 Bit #2 — 7 7/8" Y-12, in at 600', out at 1432', drilled 832' in 18 hrs.
 Bit #3 — 7 7/8" Y-13, in at 1432', present operation is drilling,
 drilled 483' in 19 hrs.
 19 hrs. — drilling
 3 hrs. — trip
 1/2 hrs. — rig repair
 1 hrs. — washing
 1/2 hrs. — rig service

NOTE: The surface bit is Bit #1.



8-9

five days since spud
 present operation is drilling
 Bit #3 — 7 7/8" Y-13, in at 1432', out at 1924', drilled 492' in 20 hrs.
 teeth are 7, bearings are 8
 Bit #4 — FP-53, in at 1924', drilled 281' in 20 hrs., weight 25-30,000 lbs.,
 55-60 RPM's, pump 14 x 5 1/2, 54 strokes per minute, 900 lbs. pressure
 20 hrs. — drilling
 2 hrs. — trip
 2 hrs. — wash to bottom
 1 1/2" estimated water flow

Pg 2





SAMPLE TOPS:

2nd Leo -- 2344'

REMARKS:

8-10

6 days since spud
 Formation is Minnelusa
 drilled 149' in 24 hrs.
 present operation is drilling.
 total rotating hrs. -- 97 3/4
 21 hrs. -- drilling
 2 1/2 hrs. -- circulating
 1/2 hrs. -- rig service

Sample Description

Drilling break at 2344'
 2nd Leo Sandstone 2344'-2360'
 sandstone, hard, calcareous and anhydritic, stained, bleeding
 oil, drilled slow but that may be because of button bit.

will drill to 2365' and test 2nd Leo

8:00 P.M. -- DST #1 2348-2378 (corrected 11 feet downhole based on pipe strap)
 Bottom hole temperature - 86°F

Open 5 minutes, SI 30 minutes, Open 30 minutes, SI 60 minutes
 opened with very strong blow off bottom of bucket in 2 minutes; decreased
 to top of water at end of second flow period.

Recovered 2250 feet of fluid-600 feet gas cut muddy water, 1650 feet of
 gas cut sulphur water

Top sample Rw 1.08 @ 64° (3800 ppm)
 Middle " 0.9 @ 70° (6800 ppm)
 Bottom " 0.89 @ 70° (6950 ppm)

HP 1163-1134
 FP₁ 379-437
 FP₂ 452-988
 SIP 1003-1006



Geologic Notes: Fair to good staining in samples but very poor porosity;
 sand very dolomitic and anhydritic. No significant
 drilling break. Considerable chattering of bit indicating
 fractures throughout 2nd Leo section; fractures in cuttings
 also. Generally poor samples.

pg. 3



POWERTECH (USA) INC.

8-11

7 days since spu
API ID 40 047 20077

17 of 35

drilled 51' in 24 hrs.

104 3/4 total rotating hrs.

7 hrs -- drilling
10 3/4 hrs -- trip
1 hrs -- wait on tester
2 1/4 hrs -- testing
2 1/4 hrs -- pick up & make & break down & load out test tool.

8:00 P.M. Drilled to 2462', ran Laterolog-SP from 2458'-2150'. Tool malfunctioned.
Tentative log tops (KB=3572)

Red Marker	2230	(+1342)
1st Leo (Meng)	2250	
2nd Leo "zone"	2351	(+1221)

pg. 4

8-12

8 days since spud
drilled 57' in 24 hrs.
116 3/4 total rotating hrs.

1/2 hrs — rig service
12 hrs — drilling
4 3/4 hrs — trip
1 hrs — circulate
6 hrs — logging

Attempted to run logs, but hole bad; will recondition hole and finish logging on August 13.

8-13

9 days since spud
8:30 a.m. on bottom logging, one log down

7 1/2 hrs — trip
3 hrs — circulate to log
3 1/2 hrs — logging
10 hrs — wash to bottom

8-14-79

4:00 P.M.

Log Tops and Calculations:

Red Marker	2229	(+1343)
1st Leo	2248	
2248-53	100% water, 25% por	
2255-58	100% water, 22% por	
2nd Leo	2350	
2350-2406	100% water, 5% por	

Ran GR Sonic Log from 596-2458

Ran Dual Induction Focused Log from 605-2460

pg. 5
6



Wulf Oil Corporation

DAILY DRILLING REPORT

DATE: August 14, 1979 OPERATOR: Wulf Oil Corporation

WELL NAME AND LOCATION: #2 Peterson, T7S, R1E, Sec. 15: S8, SW, SW, Fall River Co., SD

DEPTH: _____

BIT NUMBER: _____

DRILLING MUD PROPERTIES: WT. _____ VIS. _____ PH _____ H2O LOSS _____

REMARKS:

- 4 1/2 hrs — waiting on orders
- 5 1/2 hrs — logging
- 8 hrs — lay down collars, picking up pipe, going in hole, plugging, and lay down pipe
- 6 hrs — rigging down BOP

2132-2232	25	sos
1822-1922	25	sos
582-682	60	sos
5-25	10	sos

Plugged at 1:30 A.M.



Pg. 6



JOHN PAUL GRIES

Consulting Geologist
236 ST. CHARLES STREET
RAPID CITY, SOUTH DAKOTA

Wulf No. 2 Wayne Peterson
SE 1/4 SW 1/4 SW 1/4 sec. 15, T. 7 S., R. 1 E. Elevation: 3572 KB
Custer County, South Dakota 3564 Gnd

Contractor: Northern Wyoming Drilling Co., Joe Banks Enterprises. 682-9354
Tool pusher: Milo Wiseman, Gillette, Wyoming 307-682-9861
Spud: August 4, 1979 Plugged August 13, 1979
Well site geologist: J. P. Gries, Rapid City, S. D. 605-342-5841
Testing: B & S Testers, P. O. Box 1436, Gillette, Wyoming
Dean Boese, tester, 307-682-9626
Logging: Dresser-Atlas, Gillette, Wyoming 307-682-5123; Paul Gardner, Eng'r.
Ran BHC Acoustic w/ caliper and GR
Dual Induction focused log w/ GR
Casing: 596' of 8 5/8-inch 24 pound in 12 1/4-inch hole with 300 sacks cement

Bit record: 12 1/4-in. Reed Y-12 145628 out of hole at 600 feet
7 7/8-in. Reed Y-12 40794 out of hole at 1432. 18 hr.
7 7/8-in. Reed Y-13 212925 out of hole at 1924. 20 hr.
7 7/8-in. Reed FP-53 141792 out of hole at 2462.

Cores: none

DST No. 1. Drillers depth 2336-2366. After strapping out, corr. to 2348-2378.

Test started 4:00 PM, Aug. 10th. Open 5 minutes, shut in 5 minutes, open 30 minutes, shut in 60 minutes. Recovered 600 feet gas cut muddy water and 1650 feet of gas cut sulfur water.

Table with 3 columns: Pressures, inside, outside. Rows include IH, FH, IF-1, FF-1, IF-2, FF-2, SIP-1, SIP-2.

E-log tops: Sundance 822, Spearfish 1164, Goose Egg 1515, Minnekahta 1689, Opache 1728, Minnelusa 1817, Red marker 2232 - 2240

Handwritten numbers: 9 10 11 12 13



JOHN PAUL GRIES

Consulting Geologist

238 ST. CHARLES STREET

RAPID CITY, SOUTH DAKOTA

Wulf No. 2 Wayne Peterson

Sample description by J. P. Gries

Note: There are intervals where samples were not taken or where depth labeling is obviously in error. Due to constant inflow of water from basal Lakota sand, drilling mud was not maintained until a critical depth was reached with the result that the button bit ground the cuttings very fine. Errors of depth were found when strapping out of hole. Cuttings above these points were not corrected to the new depth, and none of the samples was lagged to correct for return time.

Lakota formation

617 - 648 sandstone, f to m, poorly sorted, gray to white, with calcareous and pyritic cement

Morrison formation

648 - 679 shale or clay, gray to greenish gray; some new light green, very waxy
711 clay, conchoidal fracture, gray to greenish gray
741 clay, same; and very light gray lithographic limestone
805 clay, same; sample almost all limestone
836 shale and clay, brownish gray to greenish gray

Sundance formation

836 - 868 clay, same, and sandstone and siltstone, greenish gray, glauc.
896 shale, greenish gray; very poor sample
930 shale, greenish gray; trace glauconitic siltstone
1020 no samples
1170 samples mislabeled
1200 shale, silty, greenish gray

Spearfish formation (E-log top at 1164)

1200 - 1230 redbeds and anhydrite, cx, white
1260 anhydrite and redbeds
1290 redbeds
1310 redbeds; trace of anhydrite
1340 redbeds
1466 no samples
1498 redbeds; mostly cavings of Jurassic shale
1529 redbeds, poor sample
1560 redbeds, good

Goose Egg formation (E-log top at 1515)

1560 - 1592 redbeds and fresh white anhydrite
1686 no samples

Wulf No. 2 Wayne Peterson (cont'd)

Minnokahta formation (E-log top at 1689)

1686 - 1717 redbeds and anhydrite; trace limestone very fx, pink, brown
 - 1817 no samples

Opeche formation (E-log top at 1728)

no samples

Minnelusa formation (E-log top at 1817)

1817 - 1993 no samples
 2013 traces of Minnelusa sand in very poor samples
 2010 dolomite, orange and white sand, traces of anhydrite. Sample caught by geologist using 80-mesh sieve
 2022 same fine ly ground mixture of dolomite and sand
 2027 dolomite, light brown, dense, 2/3; anhydrite, white, 1/3; trace sandstone
 2029 sandstone, fine, white, 1/2; dolomite, as above, 1/4; anh., 1/4
 2033 poor sample, mostly redbeds
 2043 log as anhydrite, 2/3; dolomite, 1/3
 2053 dolomite, fx, light gray-brown, 1/2; anhydrite, fx to mx, white, 1/2
 2063 anhydrite, same; 3/4; dolomite, same, 1/4
 2073 dolomite, vy fx, dns, gray, 2/3; anhydrite, white, 1/3
 2083 dolomite as above, 1/2; anhydrite, 1/2
 2093 poor sample, log as anhydrite
 2103 anhydrite, mx, white, 2/3; dolomite, very fx, dense, light gray-brown, 1/3
 2123 anhydrite, same but some very sandy, 2/3; dolomite, same, 1/3.
 2133 dolomite, finely crystalline, dense, gray-brown
 2143 dolomite, same, 1/2; anhydrite, same, 1/2
 2153 poor sample, about same; some anhydrite is very sandy
 2163 anhydrite, same, 3/4; dolomite, same, 1/4
 2173 dolomite, 2/3; anhydrite, 1/3
 2183 dolomite, same, 1/2; anhydrite, same, 1/2
 2193 poor sample; log as anhydrite
 2200 no sample
 2210 poor sample, trace splintery red shale
 2220 no sample
 2230 sample all gray shale, cvd
 2240 same
 2250 no sample
 2260 circulated sample, all shale from above
 2270 no sample
 2283 poor sample; redbeds with some Minnelusa dolomite & anhydrite
 2303 poor samples, probably fine white anhydritic sandstone and anh.
 2310 starting to build up drilling mud; dolomite and anhydrite
 2320 dolomite, fx, dense, light brown; trace sandstone, fn, white, por.
 2333 probably dolomite, vy fx, light gray; trace sandy
 2339 dolomite, fx, light gray, anhydritic, to medium gray, dense, 3/4; anhydrite, 1/4. First good sample after mudding up
 2343 dolomite, medium gray dense, fractured w/ anhydrite in the fractures; dolomite, light gray, anhydritic

20

Wulf No. 2 Peterson (cont'd)

- 2343 - 2345 sandstone, f to m, rounded to angular, cemented w/ dolomite and anhydrite, light gray; some porous pieces have fair oil staining
- 2346 sandstone, same but better staining-some bleeding oil when first examined
- 2348 poor sample; some stained sandstone as above; some new tight white siltstone or fine sandstone
- 2352 sandstone, f to m, dolomitic, gray; little staining
- 2358 sandstone, poorly sorted, larger grains well rounded, tight, gray, little staining
- 2360 sandstone, f, round to angular, tight, with dolomite and anhydrite cement
- 2365 probably dolomite, argillaceous, dark gray
- 2366 dolomite, fx, medium gray, some sandy, grading to sandstone, fine, tight, gray; much black fissile shale. Circulated sample
- SIM 2367 = 2383
- 2383 - 2388 Trip, poor sample. dolomite and some sand as above
- 2393 poor sample. Dolomite, vy fx, dense, gray to brown
- 2398 dolomite, vy fx, dense but slightly vuggy, medium gray; good sample
- 2403 dolomite, same, fractured with anhydrite healing the fractures; 2/3; sandstone, f, dolomitic, tight, gray, 1/3
- 2408 dolomite and sand, same; also more black fissile shale
- 2413 dolomite, vy fx, dense, medium gray
- 2420 dolomite, same, 2/3; sandstone, f, dolomitic, light gray
- 2425 dolomite, same, with some thin streaks black fissile shale
- 2430 dolomite, same, 1/3; shale, black, fissile, 2/3
- 2435 dolomite, same; still some black shale coming in
- 2440 dolomite, same, some sandy; traces mx white anhydrite
- 2445 dolomite, same, 2/3; sandstone, f, dolomitic, tight, gray, 2/3
- 2450 dolomite, same, 3/4; shale, black, fissile, 1/4
- 2455 dolomite, same, 1/2; sandstone, same, 1/4; shale, black, fissile, almost coaly, 1/4
- 2460 dolomite, vy fx, dense, very light gray
- 2462 dolomite, same, with some fractures healed with anhydrite
- 2462 circ. dolomite, same, 1/2; sandstone, vy f, dense, tight, no staining, 1/2. TOTAL DEPTH

21



POWERTECH (USA) INC.

R 1 E

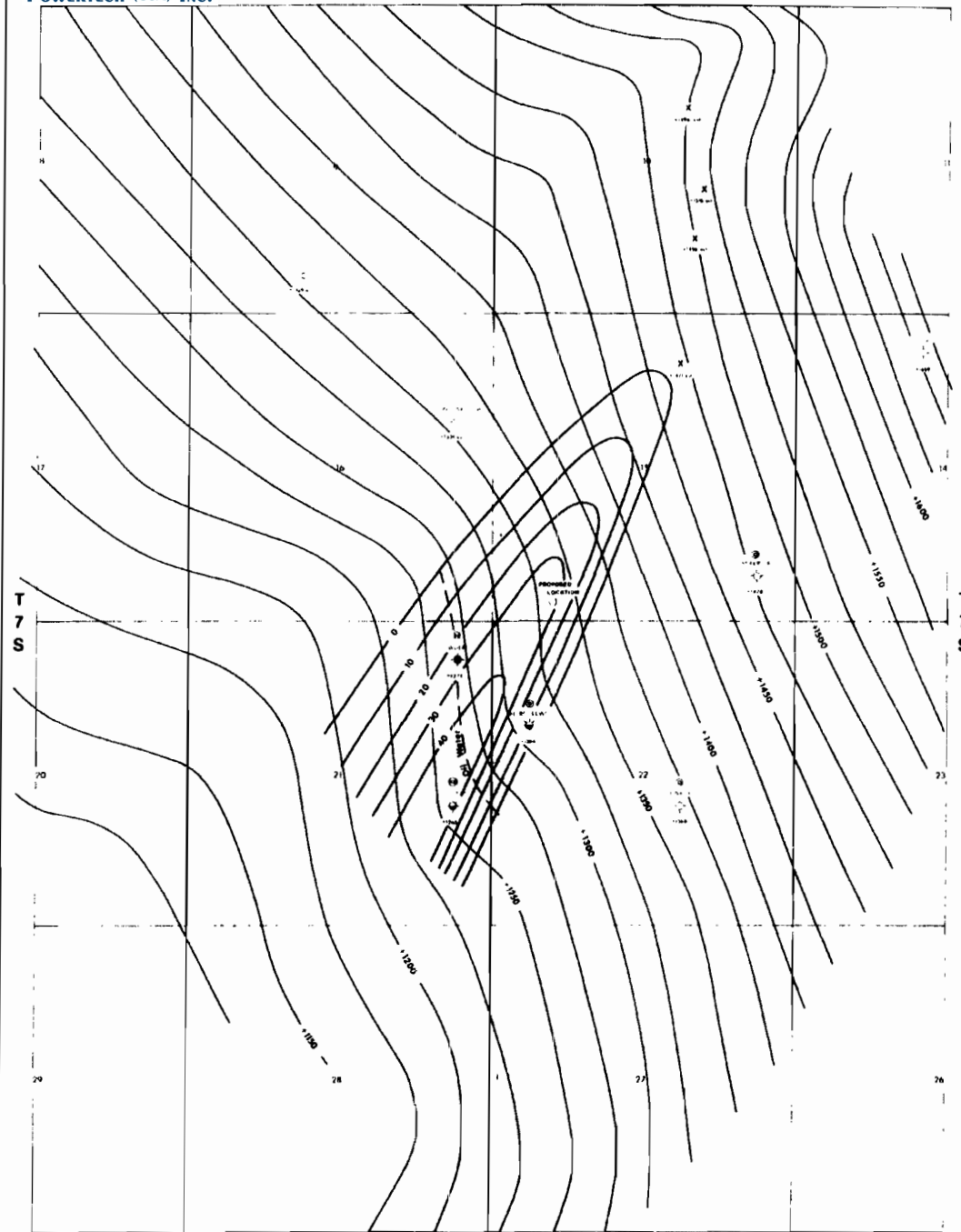

X BOUNDARY OF LAND BY THE OUTCROP, 1900'S BATHYMETRY
 O BATHYMETRY POINT
 ◆ 1:50 Feet = 1 Mile

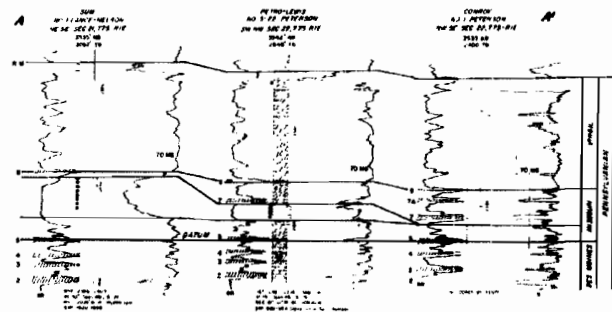

Wulf Oil Corporation

DRIFTWOOD CANYON PROSPECT

FALL RIVER COUNTY, SOUTH DAKOTA

PENNSYLVANIA RED MARKER STRUCTURE

C.L. - 25 N.

2ND LEO POROUS SANDSTONE ISOPACH

C.I. - 10 N.

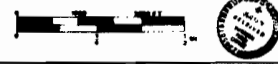



ADMINISTRATIVE / SUNDRY REPORTS



PLUGGING RECORD

Operator WULF OIL CORPORATION		Address P. O. BOX 1320 - CHADRON, NEBRASKA 69337		
Name of Lease Peterson		Well No. #2	Field & Reservoir Wildcat - Leo	
Location of Well 330 FSL, 987 FWL (SE 1/4 SW 1/4)		Sec-Twp-Rge or Block & Survey Sec. 15, T7S, R1E		County Fall River
Application to drill this well was filed in name of Wulf Oil Corporation	Has this well ever produced oil or gas No	Character of well at completion (initial production): Oil (bbls/day) N/A Gas (MCF/day) N/A Dry? YES		
Date plugged: August 13, 1979	Total depth: 2462'	Amount well producing when plugged: Oil (bbls/day) N/A Gas (MCF/day) N/A	Water (bbls./day) ??	
Name of each formation containing oil or gas. Indicate which formation open to well bore at time of plugging Leo	Fluid content of each formation See Geologists Report, Attached	Depth interval of each formation See Attached	Size, kind & depth of plugs used. Indicate zones squeeze cemented, giving amount cement. 2132-2232 25 sx. 1822-1922 25 sx. 582 - 682 40 sx. 5 - 25 10 sx. Surf. w/marker - 10 sx.	

CASING RECORD

Size pipe	Per in well (ft)	Pulled out (ft)	Left in well (ft)	Give depth and method of parting casing (shot, ripped etc)	Packers and shoes
8 5/8"	596'	-0-	596'	N/A	None

Was well filled with mud-laden fluid, according to regulations?

Indicate deepest formation containing fresh water

Yes

Lakota (not sure of type of water)

In addition to other information required on this form, if this well was plugged back for use as a fresh water well, give all pertinent details of plugging operations to base of fresh water sand, perforated interval to fresh water sand, name and address of surface owner, and attach letter from surface owner authorizing completion of this well as a water well and agreeing to assume full liability for any subsequent plugging which might be required.

on August 15, 1979 we went back in and squeezed the well with 50 sx. of cement to kill the water flow. (Cement had 3% CaCl)



USE REVERSE SIDE FOR ADDITIONAL DETAIL

Executed this the 10th day of September, 1979
 State of Nebraska
 County of Dawes

Dennis R. Stahl
 Signature of Affiant

Before me, the under-signed authority, on this day personally appeared Dennis R. Stahl known to me to be the person whose name is subscribed to the above instrument, who being by me duly sworn on oath states, that he is duly authorized to make the above report and that he has knowledge of the facts stated therein, and that said report is true and correct.

Subscribed and sworn to before me this 10th day of September, 1979

SEAL
 My commission expires _____

ANNE M. RUBECK
GENERAL NOTARY
 State of Nebraska

Notary Public in and for Dawes
 County, Nebraska

Approved SEP 21 1979 October 4, 1982

OIL AND GAS BOARD OF THE STATE OF SOUTH DAKOTA
[Signature]

**WELL COMPLETION OR RECOMPLETION
REPORT AND LOG**

FARM OR LEASE NAME

Peterson

WELL NO

#2

FIELD AND POOL, OR WILDCAT

Wildcat

NO. ACRES IN LEASE

1200.00

SEC. TWP. RGE.

SW $\frac{1}{4}$ SW $\frac{1}{4}$ Sec. 15, T7S, R1E

COUNTY

Fall River

TYPE OF COMPLETION
 Oil Well Gas Well Dry Hole
 New Well Work-Over Deepen Plug Back Same Zone Diff Zone

OPERATOR
WULF OIL CORPORATION

ADDRESS
P.O. BOX 1320 - CHADRON, NEBRASKA 69337

LOCATION (In feet from nearest lines of section or legal subdivision where possible)*

Surface 330 FSL, 987 FWL (SE $\frac{1}{4}$ SW $\frac{1}{4}$ SW $\frac{1}{4}$)

Top prod. interval

Same

At total depth

Same

PERMIT NO.

919

DATE ISSUED

6-8-79

PREVIOUS PERMIT NO.

None

DATE ISSUED

None

DATE SPUDDED

8-3-79

DATE T. D. REACHED

8-12-79

DATE COMPL. (Ready to Prod.)

Dry Hole

ELEVATIONS (DF, RKB, RT, GR, etc.)*

3564 GR 3572 KB

ELEV. CASINGHEAD

Ground

TOTAL DEPTH (MD & TVD)

2462'

PLUG BACK T. D. (MD & TVD)

N/A

IF MULTIPLE COMPL. HOW MANY*

N/A

INTERVALS DRILLED BY

ROTARY TOOLS

X

CABLE TOOLS

PRODUCING INTERVAL(S), THIS COMPLETION, TOP, BOTTOM, NAME (MD & TVD)*

None - Dry Hole

DATE DIRECTIONAL SURVEY SUBMITTED

None

TYPE ELECTRIC AND OTHER LOGS RUN (Circle those filed)

BHC Acoustic, w/caliper & GR - Dual Induction Focused Log w/GR

WAS WELL CORED

No

CASING RECORD (Report all strings set in well)

CASING SIZE	DEPTH SET (MD)	HOLE SIZE	WEIGHT LBS. FT.	PURPOSE	SACKS CEMENT	AMOUNT PULLED
8 5/8"	596' KB	12 1/2"	24#	Surface	300 sx.	None

LINER RECORD

SIZE	TOP (MD)	BOTTOM (MD)	SACKS CEMENT*	SCREEN (MD)	SIZE	DEPTH SET (MD)	PACKER SET (MD)
	None					None	

TUBING RECORD

DEPTH INTERVAL (MD)	HOLES PER FT.	SIZE AND TYPE	PURPOSE	ACID, SHOT, FRAC. CEMENT SQUEEZE, Etc. AMOUNT AND KIND OF MATERIAL USED	DEPTH INTERVAL (MD)
None				None	

PRODUCTION

DATE FIRST PRODUCTION PRODUCING METHOD (Flowing, gas lift, pumping, size & type of pump) WELL STATUS (Prod. or Shut-in)

None - Below not applicable - Dry Hole

DATE OF TEST HOURS TESTED CHOKER SIZE PRODUCTION FOR TEST OIL, Bbls. GAS, Mcf. WATER, Bbls. & G. OIL GR. PER BBL.

FLOW, TUBING PRESSURE CASING PRESSURE CALCULATED 24-HOUR RATE OIL, Bbls. GAS, Mcf. WATER, Bbls.

DISPOSITION OF GAS (Sold, used for fuel, vented, etc.)

TEST WITNESSED BY

LIST OF ATTACHMENTS

None

I hereby certify that the foregoing and attached information is complete and correct as determined from all available records

SIGNED Dennis R. S. Galt

TITLE President

DATE 9-12-79

DO NOT WRITE BELOW THIS LINE

Approved SEP 21 1979
Date

OIL AND GAS BOARD OF THE STATE OF SOUTH DAKOTA

[Signature]





STATE OF S. DAKOTA

**SUNDRY NOTICES AND
REPORT ON WELLS** v

FARM OR LEASE NAME

Peterson

WELL NO.

#2

FIELD AND POOL OR WILDCAT

Wildcat

NO. ACRES IN LEASE

1,200.00

1/4 SEC TWP. RGE

SW $\frac{1}{4}$ SW $\frac{1}{4}$ Sec. 15, T7S, R1E

COUNTY

Fall River

OIL WELL GAS WELL _____ DRY

OPERATOR

WULF OIL CORPORATION

ADDRESS

P. O. BOX 1320 - Chadron, Nebraska 69337

LOCATION (In feet from nearest lines of section or legal subdivision, where possible)

330 FSL, 987 FWL (SE $\frac{1}{4}$ SW $\frac{1}{4}$ SW $\frac{1}{4}$)

ELEVATIONS (D.F., R.K.B., R.T., GRD., etc.: how determined)

3564' GR (Survey) 3572 KB

INDICATE BELOW BY CHECK MARK NATURE OF REPORT, NOTICE OR OTHER DATA
NOTICE OF INTENTION TO: SUBSEQUENT REPORT OF:

TEST WATER SHUT-OFF

SHOOT OR ACIDIZE

WATER SHUT OFF

SHOOTING OR ACIDIZING

FRACTURE TREAT

REPAIR WELL

FRACTURE TREATMENT

REPAIRING WELL

MULTIPLE COMPLETE

PULL OR ALTER CASING

Abandonment

ALTERING CASING

ABANDON

(Note: Report results of multiple completion on Well Completion or Recompletion and Log Form, Form 4)

DESCRIBE PROPOSED OR COMPLETED OPERATIONS (Clearly state all pertinent details, and give pertinent dates, including estimated date of starting any proposed work)

Well was plugged on August 13, 1979 with plugs as follows:

2132 - 2232	25 sx
1822 - 1922	25 sx
582 - 682	40 sx
5 - 25	10 sx.
Surface w/ marker	10 sx

On August 15, 1979 it was necessary to go back in and squeeze the well with 50 sx. cement w/3% CaCl to kill the water flow.

Dry hole marker has been set, and location will be cleaned up and re-seeded as soon as possible. We would like to know if your office has any requirements as to the seed mixture it would like used when we do re-seed the location, etc.

I hereby certify that the foregoing as to any work or operation performed is a true and correct report of such work or operation.

SIGNED Donald Stal TITLE Resident DATE 9/2/79

Approved SEP 21 1979
Date

DO NOT WRITE BELOW THIS LINE

OIL AND GAS BOARD OF THE STATE OF SOUTH DAKOTA

Fred R. Steice





CORRESPONDENCE

Mr. Fred V. Steece, Supervisor
Western Field Office
36 East Chicago
Rapid City, SD 57701

Dear Mr. Steece:

This letter informs you that the surface restoration at the site of the following oil or gas test well has been completed to my satisfaction.

<u>Permit</u>	<u>Well Name and Location</u>
919	Wulf #2 Peterson, SWSW 15-7S-1E, Fall River

I am the surface owner of record.

SIGNED Wayne J. Peterson D.P. DATE 9/19/85

SURETY

NO SURETY INFORMATION FOR THIS WELL AS OF 5/18/2011

MISCELLANEOUS

**NO MISCELLANEOUS
INFORMATION FOR THIS WELL
AS OF 5/18/2011**



Oil and Gas Search for: api_no_like '40 047 20085'		
Page 1 of 1	<u>Download Database</u> (Excel spreadsheet format)	Page: Prev 1 Next

Record 1 of 1

Well Information

API No:	40 047 20085	County:	FALL RIVER
Well Name:	WULF 1A PETERSON	Location:	NENE 21-7S-1E
Permit No:	957	Total Depth:	2460
Operator Name:	WULF OIL CORPORATION	Bottom Hole:	Minnelusa
Permit Date:	12-18-1979	KB Elevation:	3545
Spud Date:	01-13-1980	Ground Elevation:	3537
Plug Date:	01-24-1980	Latitude:	43.433064
		Longitude:	-103.996978
Well Field	WILDCAT	Status	P&A
Class:	DRY HOLE	Type:	DRY HOLE

Formation Tops

<u>Formation</u>	<u>Depth (ft.)</u>
Dakota Mud	335
Lakota	545
Sundance	840
Minnekahta	1705
Minnelusa	1840
Converse	1910
Red Marker	2267
1st Leo	2290
2nd Leo	2382

Page 1 of 1 (goto top)	Page: Prev 1 Next
-------------------------------	-------------------

COUNTY: FALL RIVER
LEGAL LOCATION: NENE 21-7N-1E
API NO: 40 047 20085
PERMIT NO: 957
WELL NAME: WULF #1-A PETERSON
OPERATOR: WULF OIL CORPORATION
PERMIT ISSUED: 12/13/1979
PERMIT CLOSED: 04/21/1982
FILE LOCATION: 7N-1E-21 NENE

TARGET CODES:

WELL HISTORY / CHECKLIST

PERMIT TO DRILL / INTENT TO DRILL

WELL INSPECTION / SCOUT REPORTS

OPERATOR'S TECHNICAL REPORTS / MAPS

ADMINISTRATIVE / SUNDRY REPORTS

CORRESPONDENCE

SURETY

MISCELLANEOUS

WELL HISTORY / CHECKLIST



BOND RELEASE CHECKLIST

Well Name & Location		Permit # <u>957</u>
Wulf #1-A Peterson NENE 21-7S-1E, Fall River		API # <u>40 047 20085</u>
Bond # <u>708E675-4</u>	Date Issued _____	Date Released <u>NOV 06 1985</u>

Surface Restoration

- Pits filled
- Site Level
- Site policed
- NA Dry-hole marker solid, sealed, correctly inscribed
- No dry-hole marker desired, letter in WFO files from surface owner
- Letter of Approval from Surface owner*

Paperwork filed

- Form 4 (Completion or Recore Completion Report)
- Form 6 (Sundry Notices and Report on Wells)
- Form 7 (Plugging Report)

Geological Information Filed

- Well logs: IFS, SNP, DIL, GR, HELT, CALIP, Cement Bond, Temp, Micro, Laterlog, SWIDENS
- DST Charts and Reports
- Geologist's Report
- Results of coring and core analyses (*None cut*)
- Set of 10-foot sample cuttings (check with Bob Schoon)
(Transy to Vermillion 7-17-81)

Date NOV 1 1985 Checked By *Justice*



PERMIT CHECKLIST

Well Name and Location:	Permit # <u>957</u>
Wulf #1-A Peterson NENE 21-7S-1E, Fall River	API # <u>40 047 20085</u>
	BOND # <u>708E675-4</u>

Paperwork filed with WFO

- Organization Report
- Application
- Bond
- Permit Fee

The Following Papers sent to Operator:

- Permit (Form 2a)
- Receipt for \$100 permit fee
- Cover letter explaining material sent

Permit Fee Filed:

- Permit fee w/Cash Receipts Transmittal Form sent to State Treasurer

Notification of New Permit sent to:

- Dr. Duncan J. McGregor
- ~~XXXXXXXXXXXXXXXXXXXX~~ Mr. Warren R. Neufeld
- ~~XXXXXXXXXXXXXXXXXXXX~~ Mr. Jack Gerken
- ~~XXXXXXXXXXXXXXXXXXXX~~ Fall River County Auditor

Date 12-18-79 Check By Cheryl Pederson



PERMIT TO DRILL / INTENT TO DRILL



State Pub. Co., Pierre

APPLICATION FOR PERMIT TO:

S Dak Oil & Gas Board FORM 2

<input checked="" type="checkbox"/> DRILL	<input type="checkbox"/> DEEPEN	<input type="checkbox"/> PLUG BACK	FARM OR LEASE NAME Peterson
<input checked="" type="checkbox"/> OIL WELL	<input type="checkbox"/> GAS WELL	<input type="checkbox"/> SINGLE ZONE	WELL NO. #1-A
<input type="checkbox"/> MULTIPLE ZONE			FIELD AND POOL OR WILDCAT Wildcat
OPERATOR Wulf Oil Corporation			NO. ACRES IN LEASE 1,200.00
ADDRESS P. O. Box 1320 - Chadron, Nebraska 69337			NO. SEC. TWP. RGE NE 1/4 Sec. 21, T7S, R1E
LOCATION (In feet from an established corner of the legal subdivision) 660' FNL - 458' FEL Section 21			COUNTY Fall River
NAME AND ADDRESS OF SURFACE OWNER Peterson & Son, Inc. Edgemont, S.D. HCR - 59, Box 16		ELEVATION 3,537 GR PROPOSED DEPTH 2,400'	NO. OF WELLS ETC 1 ROTARY OR CABLE TOOLS Rotary
NAME AND ADDRESS OF CONTRACTOR Northern Wyoming Drilling Company P. O. Box 487 Gillette, Wyoming 82716		APPROXIMATE DATE WORK WILL START December 28, 1979	
IF LEASE PURCHASED WITH ANY WELLS DRILLED, FROM WHOM PURCHASED (Name and address) N/A			

PROPOSED CASING AND CEMENTING PROGRAM

SIZE OF HOLE	SIZE OF CASING	WEIGHT PER FOOT	NEW OR SECOND HAND	DEPTH	SACKS OF CEMENT
12 1/2"	8 5/8"	24#	New	250'	200 sx.
7 7/8"	5 1/2"	15.50#	New	2,400'	150 sx.

DESCRIBE PROPOSED OPERATIONS. IF PROPOSAL IS TO DEEPEN OR PLUG BACK, GIVE DATA ON PRESENT PRODUCTIVE ZONE AND PROPOSED NEW PRODUCTIVE ZONE. GIVE BLOW OUT PREVENTER PROGRAM IF ANY

We plan to drill a 2,400' well into the Leo Formation. We plan to start the well December 28, 1979 with operations lasting approximately 14 days.

Northern Wyoming Drlg. Rig #2 is equipped with a 10" Ragan Blowout Preventor which will be used while drilling the well.

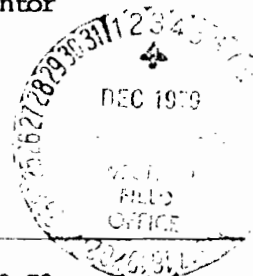

PERMIT NO. _____

SIGNED: R. Staal DATE ISSUED: _____ TITLE: President Operator DATE: 11-30-79

DO NOT WRITE BELOW THIS LINE

PERMIT NO. 957 SOUTH DAKOTA
STATE GEOLOGICAL SURVEY
APPROVAL DATE: WESTERN FIELD OFFICE 1979

CHECKED BY: [Signature] Date: _____
Supervisor, Western Field Office

COMPLETE SET OF SAMPLES, AND CORES IF TAKEN, MUST BE SUBMITTED.
SAMPLES AND CORES IF TAKEN, BELOW DEPTH MUST BE SUBMITTED.

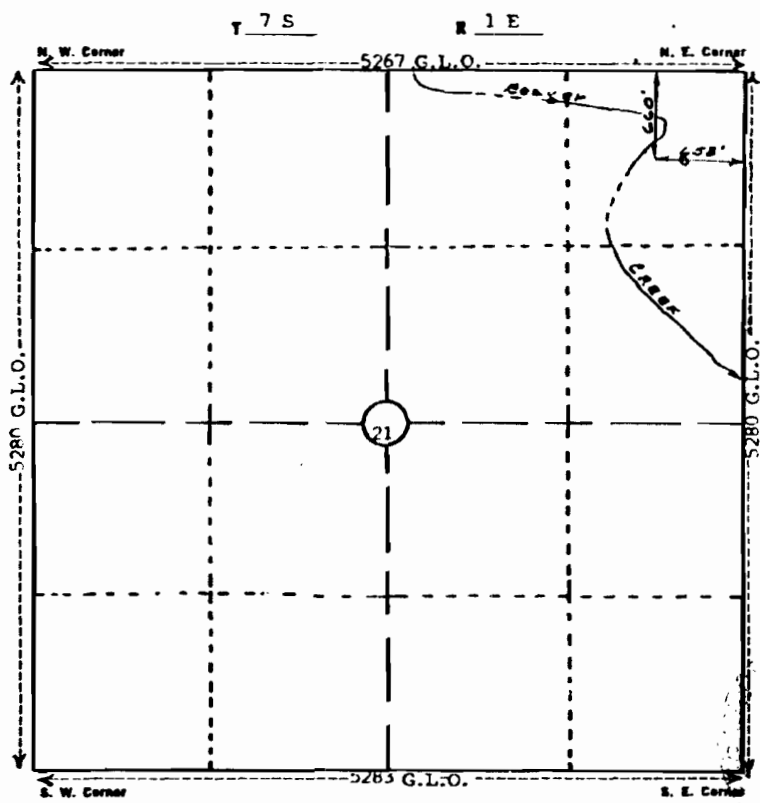

WULF OIL CC
 MAR 23 1983

Elevation at the following reference points:

- 130' North (on bank of Beaver Creek) - 3532'
- 150' West (on bank of Beaver Creek) - 3533'
- 200' South - 3532'
- 200' East (possible alternate site) - 3537.4'

I, Lawrence T. Price, of Newcastle, Wyoming, certify
 that in accordance with a request from Sherry Samuels
 of Gillette, Wyoming for Wulf Oil Corp.
P. O. Box 1320, Chadron, Nebraska 69337

That I Lawrence T. Price
 made a survey (date) November 29, 1978
 for the location and elevation of the #1 Peterson Wellsite

As shown on above map, the wellsite is in NE 1/4 NE 1/4
 Section 21, Township 7 South, Range 1 East
Fall River County, South Dakota, Elevation is 3533 feet.
above mean sea level before dozing.

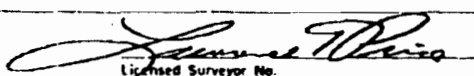
 Licensed Surveyor No.

789663.54
 Notes in Bk 312 Pg 46

Wulf Oil Corporation

P. O. Box 1320
Suite 25, Choney Center Building
CHADRON, NEBRASKA 69337
Phone 308-432-4492

WELL DRILLING PROCEDURE RECOMMENDATION

LOCATION AND WELL NAME: Wulf Oil #1-A Peterson
NE 1/4, Section 21, T7S, R1E, Fall River County,
South Dakota

METHOD OF DRILLING: Rotary

HOLE SIZE: 12 1/4" surface - 7 7/8" drilling hole

CASING: set 150' to 300' of 8 5/8" surface pipe.

MUD PROGRAM: Gel chemical mud—weight 88293#s per gallon—
viscosity of 35-45 seconds per quart—viscosity
of 75-100 for testing or logging—water loss
of 8 cc's and Ph of 8295

SURVEYS: Dual Induction Laterolog and Sonic-Gamma Ray
log from base of surface casing to TD

DRILL STEM TESTS: 1-2nd Leo Sandstone

CORES: None

SAMPLES: Every 10' from base of surface casing to TD

POOL NAME: None

ELEVATION: 3537'

DEPTH AND OBJECTIVE: 2400' or 250' below Red Marker, whichever is the
lesser.

FORMATION DATA:

Dakota	- 295'	(+3238)
Red Marker	- 2208'	(+1325)
2nd Leo	- 2328'	(+1205)

CONTRACTOR: Northern Wyoming Drilling Company

GEOLOGIST: Forest Twiford





WELL INSPECTION / SCOUT REPORTS



SOUTH DAKOTA GEOLOGICAL SURVEY
Western Field Office

SCOUT REPORT

Permit Number 957

API Number 40 047 20085

Well Name Wulf #1-A Peterson
NENE Sec. 21 T. 7S R. 1E County Fall River
 Elev. 3537 Gr Est. T.D. 2400 Actual T.D. 2460 Spudded 1/13/80
 Contractor N. Wyoming #2 Geologist Dennis Stahl, Engr.

FORMATION TOPS:

PLUGGING RECORD:

DATE PLUGGED/COMPLETED 1/24/80

CASING RECORD																	
8 5/8	FROM 0 TO 800	DRY HOLE MARKER	ADEQUATELY MARKED	MARKER STURDY	MARKER CAPPED	FENCES UP	MUD PITS FILLED	SITE LEVELLED	SITE SMOOTHED	SITE SEEDED	ROADS CLEAN	ROADS RECLAIMED	APPROVED	NOT APPROVED	LETTER TO SURFACE OWNER	LTR TO OPERATOR	SCOUTED BY
FROM	TO																
5/27/81		0	0	0	0	NA	X	X	X	0	0	X		X			KEF, WES
6/9/82		0	0	0	0	NA	X	X	X	0	X	X		X			JRC, JDO
<u>7-13-82</u>																X	<u>Jen</u>
7/11/83														X			MNS, DWE

X - Satisfactory 0 - Not satisfactory NA - Not applicable

REMARKS: 5/27/81: Includes #1 & 1A Peterson; landowner unhappy w/results. ~~NO~~ letter regarding dry hole marker. 6/8/82: Mr. Peterson not satisfied with restoration. Says he seeded site himself, but only weeds grew. Company didn't seed site. Lots of garbage in creek; looks like owner dumped it.



POWERTECH (USA) INC.

* NO. 251 hole marker de .red ltr from land owner in file dated 4/10/79.

7/11/83: Mr. Peterson contacted company in 1982. They said they would look at the site, but never have. Mr. Peterson says site is still very rough and he's not satisfied. Didn't visit site. Owner said site has not changed. MNS.



SOUTH DAKOTA GEOLOGICAL SURVEY
Western Field Office

SCOUT REPORT

Number 1

Date Scouted 1-9-80

Operator Wulf Oil Company

Permit Number 957

Farm/Lease Name #1-A Peterson

API Number 40 047 20085

NENE Sec. 21 T. 7S R. 1E County Fall River

Elev. 3537 Gr. Est. T.D. 2400 Actual T.D. 2460 Spudded 1-13-80

Contractor N. Wyoming Drilling #2 Geologist Dennis Staal, Engr.

SCOUT'S OBSERVATION:

RURT, will spud 1-13-80

Plugged: 1-24-80 *[Signature]*

DST RECORD:

#1: 23900-2410; rec 200 SG&MCW
1200 GC sulfur/lo gas

FORMATION TOPS:

Dakota-----0335
Lakota-----0545
Sundance-----0840
Basal-----1130-1195
Minnekahta-----1705

la
Minnelusa-----1840
Blue Anhyd-----1910
Red Marker-----2267
1st Leo-----2290
2nd Leo-----2382

PLUGGING RECORD:

DATE PLUGGED/~~DATE PLUGGED~~ 1-24-80

2300-2200----40 sax
1922-1800----25 sax
1149-1050----30 sax
0868-0750----50 sax
Surface ----10 sax

9-09-80: Site is clean, level, seeded. Pits are filled, there is no marker and no letter from landowner in files. *[Signature]*

CASING RECORD:

SITE INSPECTION:

8 5/8 From 0 To 800

Approved _____

From _____ To _____

Not Approved X

REMARKS:

SCOUTED BY

[Signature]
Tim Kenyon
Geologic Assistant

[Signature]
Fred V. Steece, Supervisor
Western Field Office



OPERATOR'S TECHNICAL REPORTS / MAPS



Wulf Oil Corporation

DAILY DRILLING REPORT

DATE: January 25, 1980 OPERATOR: Wulf Oil Corporation
 WELL NAME AND LOCATION: #1-A Peterson, NE 1/4, Sec 28, T7S, R1E, Fall River Co., S.D.
 DEPTH: T.D.
 BIT NUMBER: _____
 DRILLING MUD PROPERTIES: WT. _____ VIS. _____ PH _____ H₂O LOSS _____

DRILLERS REPORT:

1-23
 Present operation - rigging down
 8 hours plugging & laying down pipe
 8 hours waiting on orders
 8 hours rigging down

Cost to date - \$182,158.15

1-24 PROPERTIES: WT. 11.0 VIS. 60 PH 10 H₂O LOSS 6
 Cake - 1/32nds

DRILLERS REPORT:

Drilled 0' in last 24 hours. 135 total rotating hours
 Present operation - tripping w/DST #2; testing Leo Sand
 Recovered 1366' of gas cut water

5 1/2 hours testing
 5 hours tripping
 12 hours waiting on orders
 1 3/4 hours pick up test tool

GEOLOGISTS REPORT:

DST #2--interval tested was 2395-2404'. TD Driller-2463'; TD Logger-2459'

Opened tool with weak blow 1/4" in water bucket; decreased to surface bubbles after 5 min.
 Remained for rest of 15 min. flow.
 Closed tool for 60 min; opened tool with 1/4" blow on surface and remained steady for 20 min;
 decreased to surface bubbles for remainder of test.
 Closed tool for 120 min--no gas to surface.
 Recovered 1366' of slightly gas cut sulphur water.

Rw top sample 1.10 @ 46° F
 Rw mid sample 1.10 @ 46° F
 Rw bottom sample 1.20 @ 40° F
 Rw sample - 1.10 @ 44° F
 Rw of make-up water - 4.1 @ 50° F
 Rw of mud pit sample - 1.38 @ 50° F
 Total volume-sampler--2400 cc's
 Total volume-sample --2250 cc's

Oil - none
 Water - 2250 cc's
 Mud - none
 gas - 1.18 cubic feet
 Other - none



#1-A Peterson
 January 24, 1980
 Page 2

Pressures

IH	1388	1392
FH	1374	1392
IF ₁	30	-
FF ₁	89	-
IF ₂	179	-
FF ₂	596	-
SIP ₁	1013	1197
SIP ₂	1013	-

BOP Temperature - 86° F

Wulf Oil Corporation recommends plugging; please indicate your confirmation as soon as possible today.

1-23 GEOLOGISTS REPORT:

Ran Dual Laterolog and GR-Neutron Density Logs. TD Driller-2460'; TD Logger-2459'.
 KB-3545'.

Log Tops

Dakota	336
Lakota	545
Morrison	686
Sundance	840
Minnekahta	1707
Red Marker	2267 (+1271)
2nd Leo Zone	2385 (+1160)
2nd Leo SS	2399 (+1146)



Notes:

- 1) 2nd Leo SS is 6' high to #1 Peterson.
- 2) Based on core analysis in #1 Peterson, the zone 2399-2405 should be productive in the #1-A.
- 3) Preparing to run DST #2 2397-2404. Test should be out tomorrow a.m.

DRILLERS REPORT:

Drilled 0' in last 24 hours
 Present operation - waiting on orders

6 hours waiting on loggers
 9 hours waiting on orders
 9 hours logging

Cost to date - \$155,362.15

GEOLOGISTS REPORT:

Calculating & analyzing logs.



POWERTECH (USA) INC.

PROPERTIES: WT. 10.0 VIS. 80 PH 10 H2O LOSS 6
API ID 40 047 20085

1-22

DRILLERS REPORT:

10 days from spud. Drilled 50' in last 24 hours.
Present operation - out of hole to log.
Bit #3 7 7/8" F3--in at 2410', out @ 2460'; drilled 50' in 6 3/4 hours
30,000# wt., 55 rpms, 5 1/2 x 14 pump, 52 SPM, 950# pump pressure
6 3/4 hours drilling
9 1/2 hours tripping
3 hours rig repair
1 1/2 hours testing
3/4 hour rig service
2 1/2 hours circulating

Cost to date - \$147,794.15

GEOLOGISTS REPORT:

Drilled last 50' at 5-10 mpf with a few 2-3 mpf.
Present operation is waiting on loggers
Samples are poor and soupy--Shale shaker is freezing up because mud is sticking.
Will have sample descriptions later

DRILLING MUD
PROPERTIES: WT. 10.6 VIS. 63 PH 10 H2O LOSS 6

1-21

DRILLERS REPORT:

Drilled 0' in last 24 hours. 129 total rotating hours.
Present formation - Leo Sand
Present operation - testing Leo
Bit #2 7 7/8" FP53--in at 1810', out at 2400'; drilled 600' in 54 hours.
30,000# wt., 55 rpms, 54 SPM, 900# pump pressure
5 1/2 hours tripping
3 hours waiting on test tool
11 1/2 hours waiting on orders
1/2 hour rig service
3 3/4 hours testing

Pipe strap was 2432' and tally board was 2422'

Cost to date - \$129,411.08

GEOLOGISTS REPORT:

DST #1 from 2390-2410' (depth correction of 10'). Corrected Drilling top of Red Marker -2270'
Corrected top of 2nd Leo - 2400'

IF period of 15 minutes

Tool opened with weak blow 1/2 min. in bucket. 5 min. blow increased to 1 min. 15 minute blow increased to 2 min.

ISI period--60 minutes

FF period of 90 minutes, opened tool with weak blow 1/2 min in bucket, 5 min blow increased to 1 min, 15 min blow increased to 2 min, 15 - 90 minutes blow remained steady in bucket. Closed tool, blow died in 1 minute.

Recovered 1400' of fluid. 200' of slightly gas cut/mud cut water

1200' of gas cut sulphur smelling water. Gas would burn at tool joints.

Rw top sample - .129 @ 50° F

Rw mid sample - 0.8 @ 50° F

Rw bottom sample - 0.89 @ 50° F

Rw of make-up water - 4.1 @ 50° F

Mud pit sample Rw - 1.38 @ 50° F

Rw-sampler - 0.80 @ 50° F

Pressure in sampler - 30 psi

Total volume - 2700 cc's Total volume of sample - 2600 cc's

Oil - none

Water - 2600 cc's

Mud - none

gas - .16 cubic feet



#1-A Peterson
Page 2
January 21, 1980

Pressures

IH	1334	1388
FH	1334	1388
IF ₁	3	36
FF ₁	146	149
IF ₂	207	265
FF ₂	583	596
SIP ₁	985	1013
SIP ₂	991	1016

BOP temperature--86° F

Will drill to 2460' and run Dual Laterolog and GR-Density-Neutron to determine if additional DST's are needed.



17



Wulf Oil Corporation

DAILY DRILLING REPORT

DATE: January 20, 1980 OPERATOR: Wulf Oil Corporation
 WELL NAME AND LOCATION: #1-A Peterson, NE 1/4, Sec 22, T7S, R1E, Fall River Co., SD
 DEPTH: 2400'
 BIT NUMBER: 2
 DRILLING MUD PROPERTIES: WT. 10 VIS. 45 PH 10 H2O LOSS 6

DRILLERS REPORT:

7 days from spud. Drilled 110' in last 24 hours.
 Present formation - sand
 Present operation - circulating samples
 Bit #2 7 7/8" FP53--in at 1810; drilled 590' in 54 hours.
 30,000# wt., 55 rpms, 52 SPM, 950# pump pressure
 Survey at 2290' - 3/4° dev.
 21 hours drilling
 1 1/2 hours circulating
 1/2 hour survey
 1 hour repairs

GEOLOGISTS REPORT:

Drilling in Upper Pennsylvanian.

2:00 p.m. report --top of 2nd Leo Zone at 2390'. Good drilling break from 20 mpf to 2 mpf. Circulated samples were SS, excellent P & P, good visible stain, excellent fluor and excellent streaming cut. TD 2400'. Will test from 2385-2400'. Test should be out by noon 1-21-80.



1-21

Wulf Oil Corporation

DAILY DRILLING REPORT

DATE: January 19, 1980 OPERATOR: Wulf Oil Corporation

WELL NAME AND LOCATION: #1-A Peterson, NE 1/4 Sec 32, T7S, R1E, Fall River Co., SD

DEPTH: 2290'

BIT NUMBER: 2

DRILLING MUD PROPERTIES: WT. 9.0 VIS. 40 PH 9 H2O LOSS 10

DRILLERS REPORT:

6 days from spud. Drilled 360' in last 24 hours.
Present formation-sand; Present operation-drilling
Bit #2 7 7/8" FP53--in at 1810'; drilled 480' in 33 hours.
30,000# wt., 55 rpms, 52 SPM, 900# pump pressure

24 hours drilling

GEOLOGISTS REPORT:

Drilling in lower Permian.



Gulf Oil Corporation

DAILY DRILLING REPORT

DATE: January 16, 1980 OPERATOR: Gulf Oil Corporation
WELL NAME AND LOCATION: #1-A Peterson, NE 1/4, Sec ²¹ 32, T7S, R1E, Fall River Co., SD
DEPTH: 1035'
BIT NUMBER: 1
DRILLING MUD
PROPERTIES: WT. drilling with VIS. PH H₂O LOSS
water

DRILLERS REPORT:

3 days from spud.
Drilled 233' in last 24 hours. 43 total rotating hours.
Present formation - Shale
Present operation - working on motor
Bit #1 Y-12 — in at 802'; drilled 233' in 7 hours.
25,000# wt., 100 rpm,
7 hours drilling
15 1/2 hours waiting on cement
3/4 hour cement
1 hour circulating casing
Set 18 joints of 8 5/8" JE24# - set 792' at 802'
Cement - 380 sacs regular, 3% CaCl, 1% chip plug.
\$85,061.49 — Cumulative Costs.





BIT NUMBER: 2

DRILLING MUD
PROPERTIES: WT. drill w/water VIS. _____ PH _____ H2O LOSS _____

DRILLERS REPORT:

5 days from spud. Drilled 180' in last 24 hours.
Present operation - drilling
Bit #1 7 7/8" Y12--in at 802', out at 1810'; drilled 1008' in 31 hours,
Bit #2 7 7/8" FP-53--in at 1810'; drilled 120' so far.
25,000# wt., 55 rpm, 54 SPM, 800# pump pressure
9 hours drilling
12 1/2 hours tripping (had to borrow drill collars from another rig)
1 1/2 hours reaming
1 hour cleaning mud tank

Cost to date - \$97,224.84

GEOLOGISTS REPORT:

DRILLERS REPORT:

4 days from spud. Drilled 115' in last 24 hours. 75 total rotating hours.
Present operation - Drilling
Bit #1 7 7/8" Y12--in at 802'; drilled 948' in 29 hours.
pump 5 1/2 x 14, 54 SPM, 950# pump pressure
22 hours drilling
2 hours mixing mud

Cost to date - \$93,593.54

GEOLOGISTS REPORT:





Gulf Oil Corporation

DAILY DRILLING REPORT

DATE: January 15, 1980 OPERATOR: Gulf Oil Corporation
 WELL NAME AND LOCATION: #1-A Peterson, NE 1/4, Sec 22, T7S, R1E, Fall River Co., SD
 DEPTH: 802'
 BIT NUMBER: _____
 DRILLING MUD
 PROPERTIES: WT. water flow VIS. _____ PH _____ H2O LOSS _____

DRILLERS REPORT:

37 1/2 total rotating hours
 Present formation - shale
 Present operation - circulating casing

Bit #1-A 12 1/4" -- in at 0', out at 802'; drilled 802' in 37 1/2 hours.
 Survey at 802' - 2° deviation

19 1/2 hours drilling
 2 hours tripping
 2 1/2 hours run casing
 1/4 hour survey

Cumulative Costs - \$74,381.91

GEOLOGISTS REPORT:

DAILY DRILLING REPORT

DATE: January 14, 1980 OPERATOR: Gulf Oil Corporation
 WELL NAME AND LOCATION: #1-A Peterson, NE 1/4, Sec 22, T7S, R1E, Fall River Co., SD
 DEPTH: 300'
 BIT NUMBER: 1-A
 DRILLING MUD
 PROPERTIES: WT. 8.6 VIS. 35 PH _____ H2O LOSS _____

DRILLERS REPORT:

1 day from spud
 Drilled 300' in last 24 hours
 18 total rotating hours
 Present formation - shale
 Present operation - drilling
 Bit #1-A 12 3/4" Y-12--in at 0'; out at 300', drilled 300' in 18 hours
 110 rpm, 54 SEM, 600# pump pressure
 Survey at 300' - 1° deviation
 18 hours drilling
 6 hours waiting on water

Cumulative Costs - \$66,894.07
 GEOLOGISTS REPORT:



TIME: First Flow <u>39</u> <u>152</u> FCIF <u>1022</u> Second Flow <u>268</u> <u>611</u> FCIF <u>1022</u>		Factor: _____ Initial Hydrostatic <u>1388</u> Final Hydrostatic <u>1354</u>		APID ID 40 047 20085		
Surge No. <u>2015</u> (Clock No. <u>13496</u> hour <u>24</u>)		Ticket Number <u>1182</u>				
TIME	1st FLOW PRESSURE Psi Defl. Temp. Corr.	INITIAL CIP Psi Defl. Temp. Corr.	2nd FLOW PRESSURE Psi Defl. Temp. Corr.	FINAL CIP Psi Defl. Temp. Corr.	Pst Temp. Corr.	
P-1	.000	.102	.152	.000	.410	611
P-2	.014	.628	936	.030	.638	91
P-3	.027	.642	957	.061	.652	972
P-4	.041	.650	969	.091	.660	983
P-5	.054	.658	981	.121	.666	993
P-6	.068	.664	990	.151	.670	999
P-7	.082	.668	996	.182	.672	1001
P-8	.095	.670	999	.212	.674	1004
P-9	.109	.674	1004	.242	.676	1007
P-10	.122	.676	1007	.272	.678	1010
P-11	.136	.680	1013	.303	.680	1013
P-12	.150	.680	1013	.333	.682	1016
P-13	.163	.682	1016	.363	.683	1017
P-14	.177	.683	1017	.393	.685	1020
P-15	.190	.685	1020	.424	.686	1022
P-16	.204	.686	1022	.454	.686	1022

Remarks:



COMPANY WULF OIL COMPANY
 WELL API NO. 40 047 2065
COM-PETERSON #1-3
 FIELD WILDCAT
 COUNTY FALL RIVER
 STATE SOUTH DAKOTA

Quantitative Log Interpretation

This interpretation represents our best judgement. However, because all log analysis is based on best assumptions and empirical relationships, we cannot guarantee the accuracy of these figures. For this reason, we must disclaim any responsibility for any loss or expense which results from the use of this interpretation.

26 of 38



DEPTH	ΔT	ϕ_{AL}	D_B	ϕ_D	R_w	R_f	R_{wo}	S_w	Remarks
2399									
2403		20		12	.45	50	.4	80	If use $R_w = .65$ & 100 Then $S_w = 95$
2404-06		22		2	.45	75		100	
2406-08		25		12	.45	90		86	
2409-11		21		17	.45	30		72	
2412-14		21		17	.45	22		84	
2414-16		20.5		17.5	.45	26		78	
2416-19		23		19	.45	26		69	
2420-21		22		16	.45	70		50	
2422-23		20		10	.45	40		100	
2422-25		19		8	.45	110		80	
2425-27		18		7	.45	65		100	$S_w \sqrt{\frac{R_w}{\phi^2 R_T}}$
2298									
2304		18		8	.65	15		100	
2291-95		18		7	.65	22		100	R_w TOP 1.29 & 50
									R_w MIDDLE .9 & 50
2171-74		14		2	.65	1000		100	$R_w = .89$ & 50
2176-80		20		6	.65	30		100	$R_w = .65$ & 100
2182-88		20		6	.65	65		100	$R_w = .45$ & 100
1967-72		23		17	.65	75		55	
1973-78		23		17	.65	100		45	

References
 ΔT_{mo} D_{mo}
 ΔT_f D_f
 ΔT_{sh}

G. VAUGHN
 DRESSER ATLAS ENGINEER
 1/21/80
 DATE

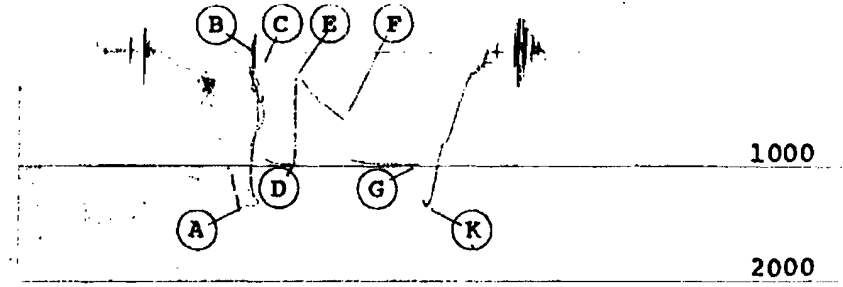

Ticket No. 1182 D.S.T.No.1 Gauge No. 3851

PRESSURE

TIME

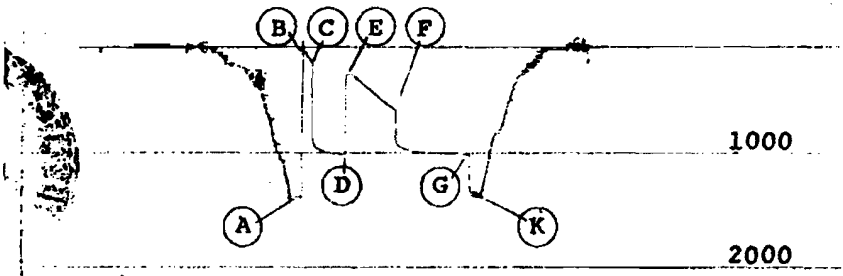

Ticket No.1182 D.S.T.No.1 Gauge No. 2015

Each Horizontal Line Equal to 10 p.s.i.

14

ADMINISTRATIVE / SUNDRY REPORTS

PLUGGING RECORD

Operator Wulf Oil Corporation		Address P.O. Box 1320, Chadron, NE 69337		
Name of Lease Peterson		Well No 1-A	Field & R servotr Wildcat - Dry	
Location of Well NE 1/4 Sec. 21, T7S, R1E		Sec/Twp/Rge or Block & Survey		County Fall River
Application to drill this well was filed in name of Wulf Oil Corporation	Has this well ever produced oil or gas No	Character of well at completion (Initial production): Oil (bbbls/day) --- Gas (MCF/day) --- Day? Yes		
Date plugged: January 25, 1980	Total depth 2460'	Amount well producing when plugged: Oil (bbbls/day) 0 Gas (MCF/day) 0 Water (bbbls/day) 0		
Name of each formation containing oil or gas. Indicate which formation opens to well-bore at time of plugging	Fluid content of each formation	Depth interval of each formation	Size, kind & depth of plugs used. Indicate zones squeeze cemented, giving amount cement.	
Dry	---	---	---	

CASING RECORD

Size pipe	Put in well (ft)	Pulled out (ft)	Left in well (ft)	Give depth and method of parting casing (shot, ripped etc)	Packers and shoes
8-5/8"	802'	0	802'	---	None

Was well filled with mud-larion fluid, according to regulations? Yes
Indicate deepest formation containing fresh water. None

In addition to other information required on this form, if this well was plugged back for use as a fresh water well, give all pertinent details of plugging operations to base of fresh water sand, perforated interval to fresh water sand, name and address of surface owner, and attach letter from surface owner authorizing completion of this well as a water well and agreeing to assume full liability for any subsequent plugging which might be required.

January 25, 1980 Plugs were placed as follows:
 2200 to 2300 40 sx.
 1800 to 1900 25 sx.
 1050 to 1150 30 sx.
 750 to 850 40 sx.
 surface no/marker 10 sx.

Plugged and abandoned 1-25-80

USE REVERSE SIDE FOR ADDITIONAL DETAIL

Executed this the 21 day of April, 1980
 State of Nebraska
 County of Chadron
 George R. Wulf Signature of Affiant

I, George R. Wulf, whose name is subscribed to the above instrument, who being by me duly sworn on oath states that he is duly authorized to make the above report and that he has knowledge of the facts stated therein, and that said report is true and correct.
 Subscribed and sworn to before me this 21 day of April, 1980.
GENERAL NOTARIAL SEAL
 STATE OF NEBRASKA
 My commission expires May 21, 1985
 Notary Public in and for
 County,

Approved APR 21 1982 Date
 DO NOT WRITE BELOW THIS LINE
 OIL AND GAS BOARD OF THE STATE OF SOUTH DAKOTA
 Fred W. Stueck

STATE OF S. DAKOTA

SUNDRY NOTICES AND REPORT ON WELLS	FARM OR LEASE NAME Peterson
	WELL NO #1A
<input checked="" type="checkbox"/> OIL WELL <input type="checkbox"/> GAS WELL <input type="checkbox"/> <input checked="" type="checkbox"/> DRY	FIELD AND POOL, OR WILDCAT Wildcat
OPERATOR WULF OIL CORPORATION	NO. ACRES IN LEASE 1,200.00
ADDRESS P. O. BOX 1320 - CHADRON, NEBRASKA 69337	SEC. TWP. RGE. NE $\frac{1}{4}$ NE $\frac{1}{4}$ Sec. 21, T7S, R1E
LOCATION (In feet from nearest lines of section or legal subdivision, where possible) 660 FNL - 458 FEL Section 21 (NE $\frac{1}{4}$ NE $\frac{1}{4}$)	COUNTY Fall River
ELEVATIONS (D.F., R.R.B., R.T., GRD., etc.; how determined) 3537' Ungraded Ground (Surveyed Elevation)	

INDICATE BELOW BY CHECK MARK NATURE OF REPORT, NOTICE OR OTHER DATA

NOTICE OF INTENTION TO:		SUBSEQUENT REPORT OF:	
TEST WATER SHUT-OFF	<input type="checkbox"/>	SHOOT OR ACIDIZE	<input type="checkbox"/>
FRACTURE TREAT	<input type="checkbox"/>	REPAIR WELL	<input type="checkbox"/>
MULTIPLE COMPLETE	<input type="checkbox"/>	PULL OR ALTER CASING	<input type="checkbox"/>
ABANDON	<input checked="" type="checkbox"/>		

(Note: Report results of multiple completion on Well Completion or Recompletion and Log Form--Form 4)

DESCRIBE PROPOSED OR COMPLETED OPERATIONS (Clearly state all pertinent details, and give pertinent dates, including estimated date of starting any proposed work)

Verbal permission was obtained to plug the well ~~XXXXXXXXXXXX~~ January 25, 1980.

Plugs to be placed as follows:

- 2200 to 2300 40 sx.
- 1800 to 1900 25 sx.
- 1050 to 1150 30 sx.
- 750 to 850 40 sx.
- Surface w/marker 10 sx.



I hereby certify that the foregoing as to any work or operation performed is a true and correct report of such work or operation.
 SIGNED Dennis R. Steel TITLE President DATE 1/31/80

DO NOT WRITE BELOW THIS LINE
 Approved _____ OIL AND GAS BOARD OF THE STATE OF SOUTH DAKOTA
 Date _____
 CONDITIONS, IF ANY: _____
 _____ Secretary



CORRESPONDENCE

Mr. Fred V. Steece, Supervisor
Western Field Office
36 East Chicago
Rapid City, SD 57701

Dear Mr. Steece:

This letter informs you that the surface restoration at the site of the following oil or gas test well has been completed to my satisfaction.

<u>Permit</u>	<u>Well Name and Location</u>
957	Wulf #1-A Peterson, NENE 21-7S-1E, Fall River

I am the surface owner of record.

SIGNED Wayne Peterson DATE 9/19/85



WULF OIL CORP.

APR 27 1982

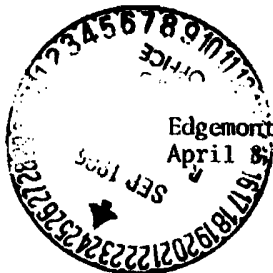

Edgemont, South Dakota 57735
April 8 1982

Wulf Oil Corporation
P.O. Box 1320
Chadron, NE 69337

Attention: Tim Schuckman

Re: Wulf #1-A Peterson
NE1/4NE1/4, 21-75-1E
Fall River County, South Dakota

Dear Mr. Schuckman:

This is to advise Wulf Oil Corporation that as surface owner
I hereby request that no dry hole marker be erected for the above
referenced well.

Very truly yours,

Wayne Peterson



March 11, 1980

**Ms. Deb Richards
Wulf Oil Corporation
P.O. Box 1320
Suite 25, Chaney Center Bldg.
Chadron, NE 69337**

Dear Ms. Richards:

**Please find enclosed the approved copy of Sundry Notices
and Report on Wells, (Form 6) for the following well:**

<u>Permit</u>	<u>Well Name and Location</u>
957	Wulf #1A Peterson, NENE 21-7S-1E, Fall River

This is for your information.

**If there is any other way that I can be of help, please
let me know.**

Sincerely,



**Fred V. Steece, Supervisor
Western Field Office**

**FVS/op
Enc.
cc: Dr. Duncan J. McGregor**

SURETY



**NO SURETY INFORMATION FOR
THIS WELL AS OF 5/18/2011**

MISCELLANEOUS

**NO MISCELLANEOUS
INFORMATION FOR THIS WELL
AS OF 5/18/2011**

SOURCE E

DEWEY BURDOCK GROUNDWATER WELL REPORT

2010 & 2011 FIELD WORK COMPLETED

(Mike Beshore, Powertech (USA) Inc., October 4, 2011)

This page intentionally left blank

Dewey Burdock Groundwater Well Report (2010 & 2011 – Field Work Completed):

During the field seasons of 2010 and 2011, Powertech personnel conducted groundwater well work at the Dewey Burdock project area. This work consisted of locating groundwater wells within the Area of Review (AOR), monitoring water levels of selected wells, measuring flow rates of artesian wells, and determining groundwater well construction information by running the down-hole camera and geophysical logging tools. Groundwater wells within the AOR are shown in **Map 1**. The conducted field work is detailed below.

Groundwater Level Measurements:

Groundwater levels were monitored by Powertech personnel on selected groundwater wells, in order to construct groundwater potentiometric surfaces for various aquifers. Standard operating procedures (SOP) for water level measurements under artesian and sub-surface conditions are shown in **Attachment 1**. Groundwater elevation data from the monitoring program are contained within **Table 1**. It should be noted that a significant amount of work had to be completed on many groundwater well surface casings in order to obtain accurate measurements. This was particularly the case for artesian groundwater wells that needed to be fully sealed up and shut in, in order to obtain accurate pressure measurements. Below is a photograph showing an example of well head work completed in order to accurately obtain artesian pressure measurements.



Artesian/Windmill Groundwater Well Flow Rates:

Groundwater wells that free-flow at the ground surface under artesian pressure and by the use of a windmill and their associated flow rates are shown in **Table 2**. This information was provided to Petrotek to incorporate into the project area groundwater flow model. Flow rates of free flowing groundwater wells was obtained by using a 5-gallon bucket, and noting the amount of time it took to fill the bucket, which yielded an estimate of the flow rate. Below are photographs of a typical artesian groundwater well and a flowing windmill within the project area, that are allowed to free-flow to the ground surface.



Groundwater Well Work Completed:

Below is a well by well summary of work completed on groundwater wells during the field season of 2011. Several tasks were completed in order to determine the construction details of many groundwater wells. A tabulated summary of groundwater well status as of September 30, 2011 is included in Table 3.

Hydro ID 5 is former oil test well API 40 047 20065

Groundwater Well Hydro ID 5:

Groundwater well number 5 is located about 0.5 miles south of the Powertech Burdock pump test location. The well is artesian and consists of a 4-inch casing. Originally the well was expected to produce water from the Chilson aquifer, however further investigations utilizing the down-hole camera and geophysical tool actually revealed that the well is screened within the lower Fall River aquifer. The geophysical log and the screened interval were sent to Powertech geologists for sub-surface geologic interpretations. The well consists of 4-inch casing to a depth of 155 feet below the ground surface, and is open hole from 155 to 175 feet.

Groundwater Well Hydro ID 6:



Groundwater well number 6 is located within the project AOR and about 1-mile south of the Powertech Burdock pump test location. This well is non-flowing and consists of a 12-inch steel casing. The static water level in the well is at about 20 feet below ground surface.



The 2-inch down-hole camera was run down the well casing in order to determine the well construction details. As with many groundwater wells in the area, it was very difficult to see the screened interval of the well due to mineralization on the inner casing walls. It appeared from the video that the steel well casing ended at a depth of 135 feet below the ground surface, below which was open bore hole to a total depth of 200 feet below ground surface. These depths correspond to other Fall River wells in the area. The geophysical logging tool was also run down the well casing to its total depth. The logs suggest that sandy facies with good porosity exists from the ground surface to 200 feet below the ground surface.

Groundwater Well Hydro ID 9:

Groundwater well number 9 is located within the AOR and south of the Powertech Burdock pump test area. The status of this well was unknown, and was identified at the ground surface by the presence of upwelling water flow from what was hypothesized to be a broken-off casing (see photo below). Historical documents from TVA identify this well as being screened within the Fall River Aquifer. Conversations with the landowner also help validate that well number 9 is screened within the Fall River Aquifer.



Powertech personnel excavated a small portion of the area near the upwelling water in an attempt to locate the groundwater well. After much effort, the broken off 2-inch groundwater well casing was located about 6 feet below the ground surface. A pipe was then attached to the casing to ensure that artesian pressure would lift the groundwater to the ground surface before repairing the well-head, but water did not flow to the ground surface.

Powertech personnel then constructed a 6-foot long 1-inch drill bit. This tool was used to ream out sulfide mineralization that had accumulated on the inner walls of the well casing. This process increased artesian flow from the well to about 1.0 gallon/minute at the ground surface.

After verifying flow from the well at the ground surface, a 2-inch pipe was placed inside the existing well casing and penetrated into the well about 2-feet. A protective riser was then placed around the 2-inch pipe, and cement was added to the space between the 2-inch well head and the protective riser. Artesian flow of 1 gallon/minute was observed at the ground surface. Below is a photograph of the final well-head configuration.



The excavated area around the well was then replaced and smoothed out to match the existing topography. The landowner can now utilize the groundwater well for stock watering purposes.



Powertech personnel were unable to run a down-hole camera on the well due to mineralization on the inner casing walls. A one inch camera, once obtained, may penetrate into the water well and allow construction details to be ascertained. This effort resulted in verifying the presence of a groundwater well and is now set up so water level measurements can be obtained.

Groundwater Well Hydro ID 37:

Groundwater well number 37 is located outside of the project boundary but within the AOR, about 0.75 miles south-east of the south-east corner of the project boundary. This groundwater well is not artesian and produces stock water by a windmill. The windmill was disassembled by Powertech personnel so access to the well could be obtained.



This groundwater well originally produce water from an unknown aquifer, but further investigations reveal that it produces from the upper Fall River aquifer according to Powertech geologists who interpreted the geophysical log and screened interval obtained from the down-hole camera. The down-hole camera revealed that the well is cased at the surface, but is open-hole from a depth of 93-145 feet below the ground surface.

Groundwater Well Hydro ID 49:

Groundwater well number 49 is located within the Powertech Dewey aquifer pump test area. This well has a construction report associated with it, is screened from a depth of 475-540 feet, and is known to be screened within the upper Fall River aquifer. The total depth of the well was verified to be 540 feet by Powertech personnel.

This groundwater well is artesian, and when first visited had a leaky surface casing. In order to be able to measure artesian pressure and groundwater levels with a high degree of accuracy, the leak in the surface casing had to be fixed, and fitted with valves to isolate the pressure gauge. Below is a photograph of surface casing work completed. There are no leaks at the ground surface, and measured water levels now correlate very well with other surrounding upper Fall River wells.



Groundwater Well Hydro ID 106:

Groundwater well number 106 is located within the AOR just north of the town of Dewey, and north of the Dewey Fault zone. The status of this 7-inch was unknown, and expected to produce from Inyan Kara aquifers. The well is artesian and flows about 0.1 gallons/minute.

The 2-inch down-hole camera was run down the well casing to determine well construction details. The casing walls were very difficult to see due to mineralization and algae growth. It appeared from the video that the steel casing ended at 160 feet below the ground surface, below which was open bore hole to a depth of 196 feet below ground surface. The geophysical logging tool was then run down the well casing to its total depth. The logs show a zone of good porosity below about 175 feet to 196 feet below the ground surface.

Groundwater Well Hydro ID 220:

Groundwater well number 220 is an existing stock well located about 1.5 miles north north-west of the Powertech Dewey pump test location, consisting of a 6-inch surface casing. Flow from the groundwater well is artesian and produces about 0.2 gallons of water per minute to a nearby stock tank. Below is a photograph of well number 220.



The down-hole camera and geophysical logging tool was used by Powertech personnel to investigate the groundwater well. The well was initially screened within an unknown aquifer. Through the use of the down-hole camera, it was determined that the well is screened from at least 463-523 feet below the ground surface. This corresponds to the upper Fall River aquifer according to Powertech geologists. However as can be seen from the down-hole video, the screened interval extends below 523 feet to an unknown depth. At 523 feet the camera could not go any deeper as the casing was broken and caved in.

Groundwater Well Hydro ID 270:

Groundwater well number 270 has been found and is located about 1.5 miles north and west of the Powertech Dewey pump test location. This groundwater well is artesian and produces about 12 gallons/minute from a 2-inch steel casing. Currently the construction details of the groundwater well are unknown, but is expected to produce from the Inyan Kara aquifers.

Powertech personnel excavated the area around the groundwater well to fix the leaky well-head and prepare it for down-hole tools. A new well-head riser pipe was installed and fitted with a valve for artesian water level measurements. The well-head is no longer leaky.

An attempt was made to run a down-hole camera in the well in order to obtain construction details. Due to mineralization on the inner casing walls, the down-hole camera would not enter the well casing. A 1-inch camera must be obtained to penetrate the well casing and obtain construction details.

Groundwater Well Hydro ID 605:

The original groundwater well database provided to Powertech from their consultants identified a ground water well hydro ID 605, which was suppose to be located about 1500 feet east of the TVA Burdock aquifer pump test well 668. There is in fact no groundwater well at this location. There is a vertical 1-inch pipe that comes up from the ground and provides water to a livestock tank. However this pipe comes from groundwater well Hydro ID 668, which provide water to this location via artesian flow from 668. There is no evidence that groundwater well 605 exists.

Groundwater Wells Hydro ID's 622 and 623:

The status of groundwater wells 622 and 623 are known as TVA construction reports exist, and were utilized in the TVA Dewey pump test as observation wells. Powertech personnel verified in the field each of these wells using a tag line to determine well depth, and most maps that show the screened interval are incorrect. Groundwater well 622 is the southern well and is the lower Chilson, as defined by the well depth being 780 feet below the ground surface. Groundwater well 623 is the northern well and is the lower Fall River, as defined by the tag line going to a depth of 580 feet below the ground surface. Furthermore, groundwater levels obtained from surrounding wells correlate perfectly with the above conclusions. Most maps that have been generated to date are labeled incorrectly, and the well symbols need to be revised to show the verified aquifer. Groundwater well 622 is Chilson and well 623 is Fall River.

Groundwater Well Hydro ID 635:

It was originally thought that Hydro ID 635 was an Sundance groundwater well located near the stock reservoir about 750 feet east of groundwater well Hydro ID 5. However, it has been confirmed that this is actually a discharge point from groundwater well Hydro ID 5. Any groundwater quality samples obtained that are labeled as Hydro ID 635 are actually from Hydro ID 5.

According to well construction reports, there was once a Sundance groundwater well in this area. The construction report shows that an oil test well was plugged back and perforated in the Sundance aquifer. Powertech personnel found a solid steel pipe sticking out of the ground about 2000 feet north of the reservoir where the Hydro ID 5 discharge point is located. It is thought that this is the location of the oil test well. The steel pipe needs to be excavated to check if the well has been plugged back to the ground surface.

Groundwater Well Hydro ID 642:

Groundwater well number 642 is located in the extreme south-east corner of the project boundary, and was originally hooked up to a windmill for livestock watering purposes. The well is currently not being used for any purpose except for groundwater monitoring. The photograph below shows the windmill structure below which groundwater well 642 is located.

This is a different oil test, API 40 047 20071, which was plugged and the dry hole marker placed. Excavation is not required. L.S. 3/12/2012



Well number 642 consists of a 5-inch steel surface casing that is in good condition. Groundwater level measurements completed by Powertech personnel yield a water level of about 5-feet below the ground surface. Below is a close up photograph of groundwater well 642.

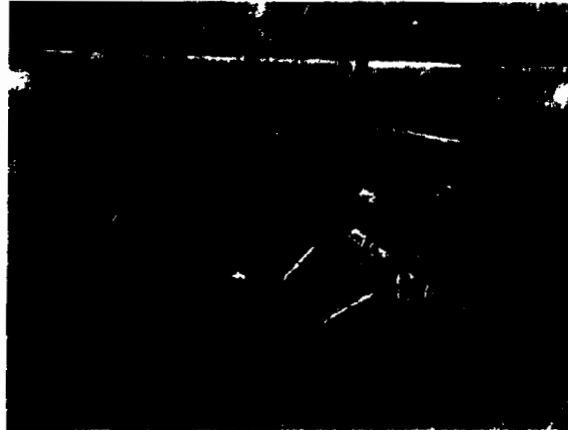

The construction details of groundwater well 642 were initially unknown. Powertech personnel ran down-hole tools on the well to determine construction information. The down-hole camera shown that the 5-inch surface casing extends to a depth of 12 feet below the ground surface, below which is an open hole to a total well depth of 33 feet. Location and geophysical log information was provided to Powertech geologists, and they interpreted the well to be producing water from surface alluvial sediments. However while running the camera down the hole, it was noted that the walls of the borehole consisted of solid-rock. The geophysical log from the hole should be re-examined to make sure the well is not completed in a sandstone formation such as the Fall River or Chilson.

Groundwater Well Hydro ID 651:

The original groundwater well database provided to Powertech from its consultants identified a groundwater well Hydro ID 651. Powertech personnel inspected this area, and confirmed that there is no groundwater well at this location. There is a stock tank at the location, but it originally received water from groundwater well Hydro ID 6 via a trenched pipeline. Inspection of an aerial photograph of this location clearly shows that a pipeline exists from well number 6 to the location of the stock tank, which was originally thought to be a stand-alone well. From conversations with the current landowner, the groundwater well 6 at one time would provide water to the stock tank, but following TVA pumping of aquifers, the well failed to deliver water to the stock tank location.

Groundwater Well Hydro ID 668:

Groundwater well number 668 is located within the project area and within the proposed groundwater aquifer exemption boundary at the location of the TVA Burdock groundwater pumping test.



As can be seen from the above photograph, this groundwater well is in excellent condition and consists of a 10-inch casing. The groundwater well is artesian and provides livestock water for the landowner. This groundwater well was used as the pumping well during the TVA Burdock aquifer test, and so there is a lot of construction information available. The TVA well construction report shows that the well produces groundwater from both the Fall River and Chilson aquifers, but Powertech personnel thought it was important to verify that information by running the down-hole camera and geophysical logging tool.

Powertech personnel ran the down-hole camera on the water well and confirmed that the well is screened at multiple intervals. The upper screen of the well extends from 300 feet to 350 feet below the ground surface. A solid, unscreened interval exists from 350 feet to 495 feet below the ground surface. From 495 feet to 550 feet below the ground surface is the lower screened interval of the well. The total depth of the well is 550 feet.

The geophysical logs ran by Powertech personnel were provided to Powertech geologists for geologic interpretation. It was confirmed that the upper screened interval of the well (300-350 feet) is in fact within the lower Fall River Formation aquifer. The lower screen of the well from 495 to 550 feet intersects the Lower Chilson Member of the Lakota aquifer. The solid casing that runs between the two screened intervals intersects the Fuson Member confining layer.

During the summer of 2011 Powertech personnel installed an inflatable packer within the groundwater well 668, in an attempt to isolate the two screened intervals of the groundwater well and conduct monitoring of the artesian pressures of each screened aquifer. That task and monitoring details are contained within a stand-alone report provided to Powertech engineering.

Dewey Burdock Groundwater Potentiometric Surface Measurements - Collected by Beshore and Van Eaton

Hydro ID or Hydro Code	SD State Plane 1983		Screened Formation	Total Depth (Feet)	TOC		Water Level Elevation (Feet) - Week of		Water Level Elevation (Feet) - Week of				
	East (Feet)	North (Feet)			Elevation (Feet)	Measuring Point Elevation (Feet)	12/13/2010	1/30/2010	1/17/2011	2/21/2011	3/21/2011	4/25/2011	
12	995376.8	434378.5	Lakota	805	3641.14	3641.51	3653.19	3653.46	3654.06	3654.26	3654.09	3654.55	
14	1002103.3	434723.34	Fall River	300	3669.88	3669.88	Not Measured	3662.91	3663.07	3663.02	3663.05	3663.15	
38	992726.9	442289.6	Fall River	494	3638.75	3639.63	3644.96	3644.23	3644.76	3646.61	3646.75	3647.01	
49	987330.6	444022.8	Fall River	600	3620.86	3621.27	3648.59	3642.36	3642.34	Not Measured	3644.64	3645.47	
436	989848.68	454700.89	Fall River	590	3739.85	3739.85	Not Measured	3707.48	3707.56	3707.31	3707.36	3707.31	
609	990133.3	447808.3	Lakota	1000	3700.67	3700.67	3688.5	3688.85	3686.81	3687.76	3687.75	3688.05	
610	989998	447988.6	Fall River	680	3704.85	3704.85	3691.75	3691.74	3691.51	3691.45	3691.33	3691.52	
611	990233.96	453955.33	Lakota	804	3737.36	3737.36	Not Measured	3691.99	3690.77	3691.03	3691.32	3691.26	
612	990153.49	454128.57	Lakota	800	3732.34	3732.34	Not Measured	3694.04	3692.69	3692.9	3693.17	3693.15	
613	990523.4	453775.8	Fall River	580	3736.93	3736.93	3700.03	3700.2	3700.25	3700.02	3700	3700.03	
615	980571	453708.9	Lakota	800	3741	3741	3689.31	3689.79	3688.49	3688.72	3688.99	3688.99	
616	990530.63	453135.16	Lakota	835	3751.04	3751.04	Not Measured	3693.43	3692.16	3692.4	3692.63	3692.6	
617	988425.25	453583.39	Lakota	810	3725.55	3725.55	Not Measured	3692.35	3691.11	3691.33	3691.58	3691.53	
622	991174.5	454033.8	Lakota	780	3754.91	3754.91	3692.85	3693.33	3692.03	3692.24	3692.5	3692.47	
623	991084.6	454311.84	Fall River	580	3753.28	3753.28	3708.51	3708.64	3708.65	3708.5	3708.53	3708.55	
628	990894.7	449719.2	Fall River	520	3731.99	3731.99	3694.78	3694.93	3694.77	3694.69	3694.42	3694.68	
631	1002575.7	449309.8	Fall River	80	3745.37	3745.37	3716.86	3716.95	3716.92	3717.11	3717.37	3717.41	
657	989882.27	454729.93	Lakota	800	3747.58	3747.58	Not Measured	3693.34	3692.06	3692.28	3692.48	3692.53	
680	1003476.6	429969.1	Lakota	436	3701.94	3701.94	3661.02	3660.69	3661.06	3661.09	3661.07	3661.45	
681	988728.3	443725.3	Fall River	600	3626.99	3630.31	3649.22	3643.89	3644.21	Not Measured	3646.05	3646.63	
682	1003538.2	431257.9	Lakota	460	3718.24	3718.24	3665.4	3665.14	3665.49	3665.54	3665.45	3665.75	
683	988610.5	446104.7	Fall River	650	3663.86	3666.64	3662.67	3659.52	3658.88	Not Measured	3660.21	3660.57	
684	1003590.38	429744.24	Lakota	423	3689.04	3689.04	Not Measured	3661.57	3661.96	3661.96	3661.95	3662.34	
685	988088.4	443409.7	Fall River	595	3627.85	3630.35	3666.88	3642.12	3642.58	Not Measured	3645.51	3646.14	
686	1003368.77	429749.56	Lakota	428	3692.06	3692.06	Not Measured	3661.23	3661.52	3661.56	3661.48	3661.96	
687	988480.18	443724.72	Fall River	608	3623.84	3624.79	Not Measured	3641.48	3641.58	Not Measured	3643.99	3644.39	
688	1003425.8	429974.4	Fall River	255	3701.26	3701.26	3663.36	3662.81	3663.09	3663.08	3663.06	3663.37	
689	988715	443789.2	Lakota	730	3627.27	3629.69	3684.72	3684.1	3678.86	Not Measured	3684.23	3683.99	
691	988762.9	443688.4	Fall River	505	3628.88	3630.29	3646.65	3643.51	3643.58	Not Measured	Not Measured	3646.12	
692	1003474.48	430014.33	Lakota	335	3704.98	3704.98	Not Measured	3663.21	3663.54	3663.57	3663.54	3663.83	
694	997116.1	426836.1	Fall River	392	3598.29	3600.69	3680.25	3640.12	3641.29	3641.2	3641.28	3641.64	
695	990783.4	439312.5	Fall River	508	3597.8	3599.12	3698.98	3634.18	3633.64	3634.95	3634.42	3634.95	
696	996936.6	427141.5	Lakota	587	3597.96	3599.91	3641.09	3649.16	3649.78	3649.6	3649.58	3650.74	
697	990748.4	439347.4	Lakota	682	3597.69	3600.3	3679.68	3675.76	3670.51	3678.16	3672.58	3672.69	
698	1004307.8	435651.1	Fall River	205	3714.25	3714.25	3679.28	3679.45	3679.38	3679.22	3679.21	3679.35	
705	997022.63	453314.89	Lakota	460	3826.42	3826.42	Not Measured	3709.77	3709.62	3709.41	3709.53	3709.64	
706	996987.91	453276.44	Fall River	316	3824.32	3824.32	Not Measured	3725.19	3725.32	3725.1	3725.29	3725.15	
3026	1012037.4	432833.2	Lakota	196	3820.48	3820.48	3680.3	3680.89	3680.78	3680.38	3680.46	3680.58	

BOLD = OUTLIERS



POWERTECH (USA) INC.

Dewey-Burdock GDP
June 2012

3.7-B-743

Appendix 3.7-B

Hydro ID	Township	Range	Section	1/4 - 1/4 Location	Coordinates East	Coordinates North	Screened Location	Well Use
1	7	1	9	SESE	1027696	429227	Chilson	Stock
2	7	1	16	SESE	1026724	423922	Chilson	Domestic
3	7	1	22	SWNW	1028593	421104	Chilson	Stock
4	7	1	15	SESE	1032516	423080	Unknown	Stock
5	7	1	14	NENW	1035181	427284	Chilson	Stock
6	7	1	14	NESE	1037218	425012	Unknown	Stock
7	7	1	23	NWNW	1033304	422417	Fall River	Domestic
8	7	1	23	SWSE	1036052	418515	Fall River	Domestic
9	7	1	23	NENE	1038003	421806	Fall River	Stock
12	7	1	4	SESE	1026978	434378	Chilson	Stock
13	7	1	3	NWNW	1028360	438470	Chilson	Domestic
14	7	1	2	NWSW	1033704	434723	Fall River	Stock
15	7	1	2	NENW	1035304	438317	Chilson	Stock
16	7	1	1	NESW	1041428	434446	Chilson	Domestic
17	7	1	12	SESW	1040223	431329	Fall River	Stock
18	7	1	9	SWSW	1022812	428960	Fall River	Domestic
37	7	2	18	NWSW	1044183	423947	Unknown	Stock
38	6	1	33	SWNW	1024328	442289	Fall River	Stock
40	6	1	30	SWNW	1013415	447182	Inyan Kara	Domestic
41	6	1	31	SWNE	1015385	442081	Unknown	Stock
42	7	1	5	SWNE	1021144	436481	Chilson	Domestic
43	6	1	34	SWSE	1031123	439436	Chilson	Domestic
49	6	1	32	NWNW	1018932	444022	Fall River	Stock
51	7	1	9	SENE	1027411	431487	Chilson	Stock
61	7	1	11	NWSE	1036832	429987	Chilson	Stock
96	41	60	22	SWSW	1011630	451853	Chilson	Domestic
102	6	1	18	SWNE	1016825	458312	Chilson	Domestic
106	6	1	18	NENE	1018099	459625	Unknown	Stock
107	6	1	18	SWNE	1017018	458158	Fall River	Domestic
108	6	1	18	SWNE	1016478	458698	Fall River	Domestic
109	6	1	17	NENW	1020801	459625	Chilson	Domestic
110	6	1	17	NENE	1023777	459643	Chilson	Stock
111	6	1	17	NWNE	1022074	459586	Fall River	Stock
112	6	1	16	SESE	1027864	455881	Fall River	Stock
113	7	2	6	NESW	1046437	434417	Unknown	Stock
114	7	2	7	SESW	1045410	428654	Unkpapa	Stock
115	6	1	18	SENE	1017697	457640	Fall River	Domestic
116	6	1	18	SENE	1017992	458111	Fall River	Stock

Status	Flow Rate (GPM)	Notes
Flowing	1.5	
	4.11	
Flowing	3	
Flowing	5	
Flowing	1.5	
	0.056	2 X 40 GPD (Est)
	0.14	5 X 40 GPD (Est)
Flowing	3	
Flowing	3.3	
	0.085	1 X 123 GPD (Est)
		Not In Use
		Windmill - Not In Use
	6	
	2.5	
Flowing	1.5	
		Not In Use
		Not In Use
	16.2	
		Not In Use
Flowing	1.2	
Flowing	12.9	
	0.11	4 X 40 GPD
	1.5	2 Residents & 2 Gardens
		Not In Use
		Not In Use
	0.085	1 X 123 GPD (Est)
		Windmill - Not In Use
		Not In Use
	0.56	40 cows X 20 GPD
	0.17	2 X 123 GPD
Flowing	1.5	Dewey Post Office

Hydro ID	Township	Range	Section	1/4 - 1/4 Location	Coordinates East	Coordinates North	Screened Location	Well Use
117	6	1	8	SWSE	1022177	460796	Unknown	Stock
138	6	1	18	NENE	1017537	459030	Fall River	Domestic
147	6	1	17	NESW	1020879	456566	Chilson	Monitor
220	6	1	19	SENE	1017872	452334	Unknown	Stock
270	6	1	19	NWSW	1014108	451942	Unknown	Stock
436	6	1	20	NWNE	1021450	454700	Fall River	Monitor
506	7	2	8	SWNW	1050129	430704	Unkpapa	Stock
510	7	1	12	SESE	1042933	428178	Chilson	Stock
609	6	1	29	SWNE	1021735	447808	Chilson	Monitor
610	6	1	29	SWNE	1021599	447969	Fall River	Monitor
611	6	1	20	NWNE	1021835	453954	Chilson	Monitor
612	6	1	20	NWNE	1021755	454128	Chilson	Monitor
613	6	1	20	NWNE	1022125	453775	Fall River	Monitor
614	6	1	20	NWNE	1022185	453769	Fuson	Monitor
615	6	1	20	NWNE	1022172	453708	Chilson	Monitor
616	6	1	20	SWNE	1022132	453134	Chilson	Monitor
617	6	1	20	NENW	1021026	453582	Chilson	Monitor
618	7	1	2	SENE	1038074	435906	Unknown	Stock
619	7	1	2	SENW	1034866	436729	Chilson	Stock
620	6	1	35	NWNW	1033951	443209	Chilson	Stock
622	6	1	20	NENE	1022776	454033	Chilson	Monitor
623	6	1	20	NENE	1022686	454311	Fall River	Monitor
628	6	1	20	SESE	1022496	449718	Fall River	Stock
631	6	1	23	SWSW	1034177	449309	Fall River	Stock
635	7	1	14	NENW	1004085	427131	Sundance	Monitor
637	7	1	11	NESE	1038075	430320	Unknown	Monitor
638	7	1	2	NENE	1038269	437976	Fall River	Monitor
639	7	2	7	SENW	1045704	430722	Unknown	Stock
640	7	1	12	SESE	1043010	427965	Unknown	Stock
642	7	1	12	SESE	1042926	428042	Unknown	Stock
645	7	1	16	NENE	1027681	427998	Unknown	Stock
650	7	1	1	SESE	1043781	433331	Chilson	Stock
656	6	1	31	SENW	1014230	442000	Unknown	Stock
657	6	1	20	NWNE	1021483	454729	Chilson	Monitor
662	7	1	11	SESW	1035381	428928	Unknown	Monitor
668	7	1	15	NWNE	1031029	427450	Inyan Kara	Stock
676	6	1	34	SESW	1030846	439891	Alluvial	Monitor
677	7	1	4	SWSW	1023527	434077	Alluvial	Monitor

Status	Flow Rate (GPM)	Notes
		Not In Use
	0.75	2 Residents & 10 Horses
Flowing	0.2	
Flowing	0.8	
Flowing	6.25	
Flowing	6.25	Measured @ ST



POWERTECH (USA) INC.

Dewey-Burdock GDP
June 2012

3.7-B-745

Appendix 3.7-B

Hydro ID	Township	Range	Section	1/4 - 1/4 Location	Coordinates East	Coordinates North	Screened Location	Well Use	Total Depth	Screened Interval	Screened Aquifer	Work to Complete
1	7	1	9	SESE	1027696	429227	Chilson	Stock				1 Inch Camera
2	7	1	16	SESE	1026724	423922	Chilson	Domestic	650	566-650		Need Access, Artesian
3	7	1	22	SWNW	1028593	421104	Chilson	Stock				1 Inch Camera
4	7	1	15	SESE	1032516	423080	Unknown	Stock				1 Inch Camera & Access
5	7	1	14	NENW	1035181	427284	Fall River	Stock	175	155-175	Lower Fall River	Complete
6	7	1	14	NESE	1037218	425012	Unknown	Stock	200	135-200		Complete
7	7	1	23	NWNW	1033304	422417	Fall River	Domestic	200			Need Access, Artesian
8	7	1	23	SWSE	1036052	418515	Fall River	Domestic	240			Need Access, Artesian
9	7	1	23	NENE	1038003	421806	Fall River	Stock				1 Inch Camera
12	7	1	4	SESE	1026978	434378	Chilson	Stock	805			1 Inch Camera
13	7	1	3	NWNW	1028360	438470	Chilson	Domestic	625	580-625		Complete
14	7	1	2	NWSW	1033704	434723	Fall River	Stock	300		Lower Fall River	1 Inch Camera
15	7	1	2	NENW	1035304	438317	Chilson	Stock				Ready, Dry Hole
16	7	1	1	NESW	1041428	434446	Chilson	Domestic	330			Remove Shed
17	7	1	12	SENW	1040223	431329	Fall River	Stock				Need Access, Pull Windmill
18	7	1	9	SWSW	1022812	428960	Fall River	Domestic	527			Need Access
37	7	2	18	NWSW	1044183	423947	Fall River	Stock	145	93-145	Upper Fall River	Complete
38	6	1	33	SWNW	1024328	442289	Fall River	Stock	494			Pull Pump
40	6	1	30	SWNW	1013415	447182	Inyan Kara	Domestic				1 Inch Camera & Access
41	6	1	31	SWNE	1015385	442081	Unknown	Stock				Need Access
42	7	1	5	SWNE	1021144	436481	Chilson	Domestic	600			Need Access, Artesian
43	6	1	34	SWSE	1031123	439436	Chilson	Domestic				Need Access
49	6	1	32	NWNW	1018932	444022	Fall River	Stock	600	475-540	Upper Fall River	Complete
51	7	1	9	SENE	1027411	431487	Chilson	Stock				Need Access
61	7	1	11	NWSE	1036832	429987	Chilson	Stock				Ready
96	41	60	22	SWSW	1011630	451853	Chilson	Domestic				Need Access
102	6	1	18	SWNE	1016825	458312	Chilson	Domestic				Need Access
106	6	1	18	NENE	1018099	459625	Unknown	Stock	196	160-196		Complete
107	6	1	18	SWNE	1017018	458158	Fall River	Domestic				Need Access
108	6	1	18	SWNE	1016478	458698	Fall River	Domestic				Need Access
109	6	1	17	NENW	1020801	459625	Chilson	Domestic				Need Access
110	6	1	17	NENE	1023777	459643	Chilson	Stock				Need Access
111	6	1	17	NWNE	1022074	459586	Fall River	Stock				Need Access
112	6	1	16	SESE	1027864	455881	Fall River	Stock				Need Access, Pull Windmill
113	7	2	6	NESW	1046437	434417	Unknown	Stock				Need Access, Pull Windmill
114	7	2	7	SESW	1045410	428654	Unkpapa	Stock				Need Access, Pull Windmill
115	6	1	18	SENE	1017697	457640	Fall River	Domestic				Need Access
116	6	1	18	SENE	1017992	458111	Fall River	Stock				Need Access
117	6	1	8	SWSE	1022177	460796	Unknown	Stock				Pull Pump
138	6	1	18	NENE	1017537	459030	Fall River	Domestic				Need Access
147	6	1	17	NESW	1020879	456566	Chilson	Monitor	750	650-750		Complete
220	6	1	19	SENE	1017872	452334	Unknown	Stock		463-523+	Upper Fall River	Complete
270	6	1	19	NWSW	1014108	451942	Unknown	Stock				1 Inch Camera

Dewey-Burdock GDP
June 2012

3.7-B-748

Appendix 3.7-B

Hydro ID	Township	Range	Section	1/4 - 1/4 Location	Coordinates East	Coordinates North	Screened Location	Well Use	Total Depth	Screened Interval	Screened Aquifer	Work to Complete
436	6	1	20	NWNE	1021450	454700	Fall River	Monitor	590	505-590	Lower Fall River	Complete
506	7	2	8	SWNW	1050129	430704	Unkpapa	Stock				Ready
510	7	1	12	SESE	1042933	428178	Chilson	Stock				Need Access, Pull Pump
609	6	1	29	SWNE	1021735	447808	Chilson	Monitor	1000	903-966	Lower Chilson	Complete
610	6	1	29	SWNE	1021599	447969	Fall River	Monitor	680	630-672	Lower Fall River	Complete
611	6	1	20	NWNE	1021835	453954	Chilson	Monitor	804	695-730, 755-800	Middle Chilson, Lower Chilson	Complete
612	6	1	20	NWNE	1021755	454128	Chilson	Monitor	800	692-800	Lower Chilson	Complete
613	6	1	20	NWNE	1022125	453775	Fall River	Monitor	580	504-580	Lower Fall River	Complete
614	6	1	20	NWNE	1022185	453769	Fuson	Monitor	620	609-620	Fuson	Complete
615	6	1	20	NWNE	1022172	453708	Chilson	Monitor	800	712-800	Lower Chilson	Complete
616	6	1	20	SWNE	1022132	453134	Chilson	Monitor	835	735-835	Lower Chilson	Complete
617	6	1	20	NENW	1021026	453582	Chilson	Monitor	810	715-810	Lower Chilson	Complete
618	7	1	2	SENE	1038074	435906	Unknown	Stock				Complete
619	7	1	2	SENE	1034866	436729	Chilson	Stock	288	230-288	Upper Chilson	Pull Pump
620	6	1	35	MWNW	1033951	443209	Chilson	Stock				Need Access, Pull Pump
622	6	1	20	NENE	1022776	454033	Chilson	Monitor	780	714-780	Lower Chilson	Complete
623	6	1	20	NENE	1022686	454311	Fall River	Monitor	580	503-580	Lower Fall River	Complete
628	6	1	20	SESE	1022496	449718	Fall River	Stock	520		Upper Fall River	Need Access, Pull Pump
631	6	1	23	SWSW	1034177	449309	Fall River	Stock	80	30-80	Lower Fall River	Need Access, Pull Pump
635	7	1	14	NENW	1004085	427131	Sundance	Monitor				Not A Well
637	7	1	11	NESE	1088075	430320	Unknown	Monitor				1 Inch Camera
638	7	1	2	NENE	1038269	437976	Fall River	Monitor				Plugged?, Need to Verify
639	7	2	7	SENE	1045704	430722	Unknown	Stock				Ready, Hand Dug Well
640	7	1	12	SESE	1043010	427965	Unknown	Stock				Pull Pump
642	7	1	12	SESE	1042926	428042	Alluvial	Stock	33	12-33	Alluvial	Complete
645	7	1	16	NENE	1027681	427998	Unknown	Stock				Need Access, Pull Pump
650	7	1	1	SESE	1043781	433331	Chilson	Stock				Pull Pump
656	6	1	31	SENE	1014230	442000	Unknown	Stock				Remove Shed to Access
657	6	1	20	NWNE	1021483	454729	Chilson	Monitor	800	715-800	Lower Chilson	Complete
662	7	1	11	SESW	1035381	428928	Unknown	Monitor				1 Inch Camera
668	7	1	15	NWNE	1031029	427450	Inyan Kara	Stock	550	300-350, 495-550	Lower Fall River, Lower Chilson	Complete
676	6	1	34	SESW	1030846	439891	Alluvial	Monitor	22.5	12-22	Alluvial	Complete
677	7	1	4	SWSW	1023527	434077	Alluvial	Monitor	14.5	4-14	Alluvial	Complete
678	7	1	9	SWNE	1026522	431925	Alluvial	Monitor	14.5	4-14	Alluvial	Complete
679	6	1	27	NWSE	1032294	446245	Alluvial	Monitor	39	29-39	Alluvial	Complete
680	7	1	11	NESW	1035078	429969	Chilson	Monitor	436	426-436	Lower Chilson	Complete
681	6	1	32	NENW	1020330	443725	Fall River	Monitor	600	585-600	Lower Fall River	Complete
682	7	1	11	SENE	1035139	431257	Chilson	Monitor	460	450-460	Lower Chilson	Complete
683	6	1	29	NESW	1020212	446104	Fall River	Monitor	650	635-650	Lower Fall River	Complete
684	7	1	11	NESW	1035191	429744	Chilson	Monitor	423	413-423	Lower Chilson	Complete
685	6	1	32	NWNE	1020690	443409	Fall River	Monitor	595	580-595	Lower Fall River	Complete

Dewey-Burdock GDP
June 2012

3.7-B-749

Appendix 3.7-B

Hydro ID	Township	Range	Section	1/4 - 1/4 Location	Coordinates East	Coordinates North	Screened Location	Well Use	Total Depth	Screened Interval	Screened Aquifer	Work to Complete
686	7	1	11	NESW	1034970	429749	Chilson	Monitor	428	418-428	Lower Chilson	Complete
687	6	1	32	NENW	1020081	443724	Fall River	Monitor	608	593-608	Lower Fall River	Complete
688	7	1	11	NESW	1035027	429974	Fall River	Monitor	255	245-255	Lower Fall River	Complete
689	6	1	32	NENW	1020316	443789	Chilson	Monitor	730	715-730	Middle Chilson	Complete
690	7	1	11	NESW	1035114	429970	Unkpapa	Monitor	631	621-631	Unkpapa	Complete
691	6	1	32	NENW	1020364	443698	Fall River	Monitor	505	490-505	Upper Fall River	Complete
692	7	1	11	NESW	1035075	430014	Chilson	Monitor	335	325-335	Upper Chilson	Complete
693	6	1	32	NENW	1020327	443661	Unkpapa	Monitor	930	910-930	Unkpapa	Complete
694	7	1	15	NWNW	1028717	426836	Fall River	Monitor	392	377-392	Lower Fall River	Complete
695	6	1	32	SESE	1022385	439312	Fall River	Monitor	508	493-508	Lower Fall River	Complete
696	7	1	15	NWNW	1028538	427141	Chilson	Monitor	587	572-587	Middle Chilson	Complete
697	6	1	32	SESE	1022350	439347	Chilson	Monitor	682	667-682	Middle Chilson	Complete
698	7	1	2	NESW	1035909	435651	Fall River	Monitor	205	180-205	Lower Fall River	Complete
703	7	1	1	SWSE	1041621	434334	Unkpapa	Domestic	525	475-525	Unkpapa	Complete
704	7	1	5	SWNE	1020966	436647	Chilson	Domestic				Complete
705	6	1	21	NENE	1028624	453314	Chilson	Monitor	460	428-458	Middle Chilson	Complete
706	6	1	21	NENE	1028589	453276	Fall River	Monitor	316	284-314	Lower Fall River	Complete
707	6	1	34	SWNE	1031935	441809	Alluvial	Monitor	44	30-40	Alluvial	Complete
708	7	1	3	SESW	1090254	434094	Alluvial	Monitor	28	17-27	Alluvial	Complete
709	7	1	15	SESW	1029286	426603	Alluvial	Monitor	40	28-38	Alluvial	Complete
3026	7	1	12	NENE	1043638	432833	Chilson	Monitor	196	166-196	Middle Chilson	Complete
4002	6	1	30	NWSW	1013414	446931	Inyan Kara	Domestic				Need Access, 1 Inch Camera
7002	7	1	23	NWNW	1033333	421931	Chilson	Stock	500			Need Access, Artesian



Powertech (USA) Inc.
Standard Operating Procedure (SOP)
Groundwater Well Water Level Monitoring

This SOP outlines procedures for measuring and documenting artesian and sub-surface water levels within groundwater monitoring wells.

Materials:

- Powertech Groundwater Well Monitoring Data Sheet.
- Electric Logging Water Level Measuring Tape.
- High-Resolution Digital Pressure Gauge.
- Tape Measure with 1/100th foot accuracy.

Personal Protective Equipment (PPE):

- Several potential hazards exist during groundwater well water level monitoring. These include but are limited to pinch-points, pressure, slip/trip/fall, and environmental hazards. Appropriate PPE must always be utilized when conducting groundwater well water level monitoring.

Documentation:

- The person conducting the groundwater well monitoring must completely and accurately fill out the Groundwater Well Monitoring Data Sheet.
- The person conducting the groundwater well monitoring must read and sign the SOP for Groundwater Well Water Level Monitoring. A copy of the signed SOP should be filed at the nearest Powertech Field Office. A copy of the SOP must accompany the person conducting the monitoring in the field.

Procedures:

1. Completely fill in the Powertech Groundwater Well Monitoring Data Sheet.
2. Procedure for pressurized artesian groundwater wells.
 - a. Fully shut-in the artesian groundwater well so that there are no leaks that result in the loss of artesian pressure. This may require some tightening or replacement of plumbing fixtures. A closable valve should be fitted to the well head that allows the attachment of the high-resolution digital pressure gauge. This valve and other plumbing fittings should not be removed, so that future measurements can be conducted at the same elevation.
 - b. Make sure that all air has been evacuated from the artesian groundwater well. The high-resolution digital pressure gauge can now be installed and turned on. Make sure that the gauge has been reset, or zeroed out.

- c. Take an initial pressure measurement in pounds/square-inch (PSI) and document the measurement and time on the Powertech Groundwater Well Monitoring Data Sheet. Pressure measurements should be taken with an accuracy of 0.01 PSI.
 - d. Continue to take and document pressure measurements until the artesian water well pressure has stabilized. A stabilized artesian pressure measurement is defined as one of the following:
 - a. A pressure measurement that reaches a maximum value, and then slightly decreases, but does not exceed the maximum documented value within a period of 15 minutes.
 - b. If the pressure measurements DO NOT fluctuate more than 0.04 PSI (or 0.1 feet of water head) over 3 measurements within a 15 minute time period.
 - e. Make sure to measure the vertical distance between the surveyed control point (Top of Casing or Survey Pin) and the pressure sensor diaphragm on the pressure gauge. This measurement must be taken with an accuracy of 1/100th of a foot.
3. Procedure for sub-surface water level groundwater wells.
- a. Lower the probe of an Electric Logging Water Level Measuring Tape into the groundwater well, and lower at a slow rate. Be careful not to let the probe and tape unwind too quickly as they may come free of the spool and be lost into the well.
 - b. Also make sure that the probe sensitivity is adequately adjusted. The deeper the water is in the well, the less sensitivity the probe will require. This is important as condensation in the well could give false readings of the water level in the well.
 - c. Measure and document the depth to the water in the well from the top of the well casing. This measurement must be logged with an accuracy of 1/100th of a foot. Make sure to take several measurements to ensure an accurate final water level.

I certify that I have read and understand the content of this Standard Operating Procedure.

Employee Signature: _____ Date: _____

SOURCE F

RESPEC RESPONSES TO NUCLEAR REGULATORY COMMISSION COMMENTS (REVISION 1)

(Letter from Crystal Hocking, RESPEC, to Mark Hollenbeck, Powertech (USA) Inc., July 22, 2010)

This page intentionally left blank



External Memorandum

To: Mr. Mark Hollenbeck
Powertech (USA) Inc.
310 2nd Avenue
P.O. Box 812
Edgemont, SD 57735

cc: Mr. John Mays, Powertech
Mr. Cory Foreman, RESPEC
Project Central File 1853 — Category A

From: Ms. Crystal Hocking
Staff Geologist
RESPEC
P.O. Box 725
Rapid City, SD 57709

Date: July 22, 2010

Subject: Responses to Nuclear Regulatory Commission Comments (Revision 1)

The purpose of this memorandum is to respond to the five tasks designated by Powertech to help respond to Nuclear Regulatory Commission (NRC) comments regarding the technical report. These tasks were outlined by Mr. John Mays and you at a meeting with RESPEC on June 24, 2010.

Task 1. Check Well 650 and Compare Water Level to Depth to Lakota to Determine Saturated/Unsaturated Conditions at That Location

In an effort to help identify areas where the Lakota Formation is fully saturated, water level measurements of Lakota wells were compared to the elevation of the top of the aquifer. Tables 1 and 2 include well completion and water level measurements for Wells 650, 3026, and 619. Well locations are shown on Figure 1.

The elevation of the top of the Lakota at Well 650, 3,775 feet, was approximated by interpolating the known depth to Lakota at Well 3026 with the location of the outcrop (where the depth equals 0). The average water level measurement is at 3,682 feet elevation, or 92 feet below the approximate top of the Lakota. At the location of Well 3026 (DB08-01-06), the water level is approximately 60 feet below the top of the Lakota Formation. At both of these wells, the Lakota is only partially saturated. At Well 619, the water level in the Lakota is approximately 300 feet above the top of the Lakota Aquifer based on estimates of the Lakota elevation from the sitewide structural contour maps; here the Lakota is fully saturated.

Table 1. Well Completion for Wells 650, 3026, and 619

Hydro I.D. or Hydro Code	650	3026	619
Powertech Borehole I.D.		DB08-01-06	
Formation	Lakota	Lakota	Lakota
Subsurface (SS) or Free-Flowing (FF)	SS	SS	SS
Depth (ft)	Unknown	196	280
Screened Interval (ft)	Unknown	166–196	Unknown
Measuring Point	Top of 8-inch steel casing	Top of 6-inch casing pipe	Top of 5-inch steel coupling on casing
Surveyed Well Casing Elevation (ft)		3,820.48	3,700.12
Stick Up (Well Casing Mark) (ft)		-0.20	0.00
Surveyed Control Point Elevation (ft)	3,821.06		3,698.82
Stick Up (Control Point) (ft)	-0.56		
Calculated Measuring Point Elevation (ft)	3,821.62	3,820.68	3,700.12

In an effort to better delineate where the Lakota Aquifer becomes fully saturated, RESPEC recommends Powertech acquire water levels from two or three additional Lakota wells in close proximity to the outcrop. Recommended wells include Wells 16, 61, and/or 620 (Figure 1). None of these wells have well completion reports, although they are listed in Tennessee Valley Authority (TVA) reports as being completed within the Lakota. Well 16 is listed in the TVA draft Environmental Impact Statement (EIS) as having a water elevation of 3,747 feet, and based on approximations from structure contour maps, the elevation of the Lakota is 3,730 feet or just below the water level of the Lakota. Based on this information alone, it appears that Well 16 is at or very near the area where the Lakota Aquifer becomes fully saturated. From this, it is reasonable to assume that the transition from saturated to unsaturated conditions in the Lakota is located geographically in the central to western portion of the Fall River Formation outcrop. However, because of fluctuations in the water table with time and precipitation patterns, it is highly recommended to take a new water level measurement at Well 16, the only Lakota well located on the Fall River outcrop.

Task 2. Check Field Notes to Verify Data on Existing Potentiometric Surfaces Is Correct

Water level data for wells with questionable data were spot checked to compare field notes with the tabular data. An explanation of the results is provided in the following sections.

— DRAFT —

Table 2. Water Level Measurements for Wells 650, 3026, and 619

Hydro I.D. or Hydro Code	650	3026	619
Powertech Borehole I.D.		DB08-01-06	
Date	ft above mean sea level		
2007-09-27			3,679.13
2007-10-02	3,682.35		
2007-11-09	3,682.35		3,679.19
2008-02-20	3,682.13		
2008-03-24	3,681.92		
2008-03-30		3,681.89	
2008-04-22		3,681.77	
2008-05-21		3,682.13	
2008-05-28		3,681.73	
2008-05-30	3,682.00		
2008-06-24		3,681.85	
2008-07-13		3,681.78	
2008-08-19		3,681.63	
2008-09-22		3,681.78	
2008-10-20		3,681.83	
2008-11-18		3,681.85	
2008-12-17		3,682.50	
2009-01-20		3,682.53	
2009-02-24		3,682.50	
Number	5	13	2
Mean Water Level Elevation	3,682	3,682	3,679
Elevation of Top Lakota	3,775^(a)	3,741	3,375
Difference^(b)	-92	-59	304

(a) Based on interpolation.

(b) Negative value indicates Lakota Aquifer is unsaturated at well location.
Positive value indicates Lakota Aquifer is saturated at well location.

— DRAFT —

RSI-1853-10-033

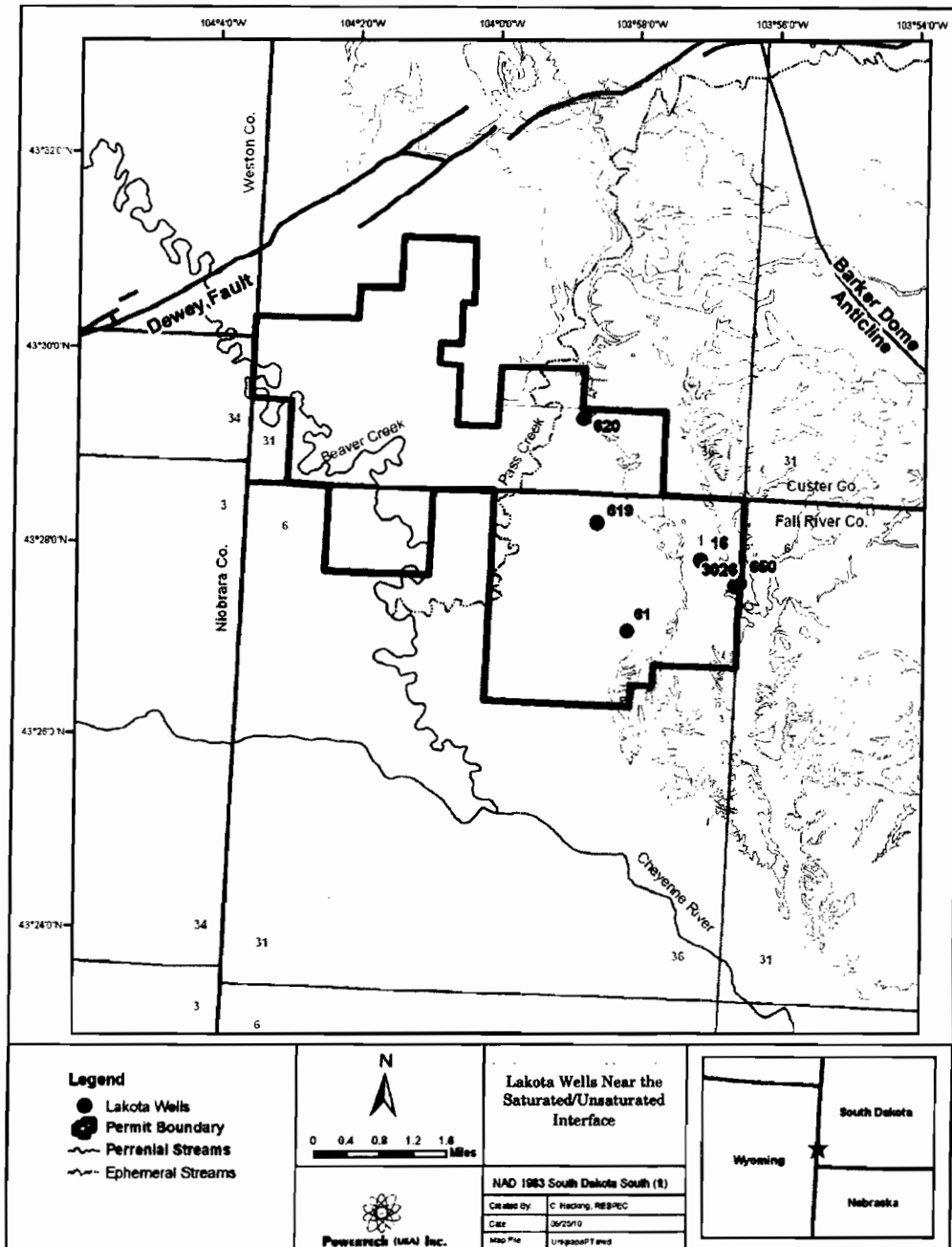

Figure 1. Lakota Wells Near the Saturated/Unsaturated Interface.

— DRAFT —

Fall River Aquifer

Well 613 and Well 622. These two wells are both completed to similar depth in the Fall River Formation (well completion reports available) and are located about 700 feet apart. Both wells have a total depth of 580 feet and similar surface elevation with well 613 screened between 504 and 580 feet and well 622 screened between 503 and 580 feet. The average water levels reported on Figure 2.7-14 of the NRC technical report (TR) are correct as compared to original field notes. These two wells have a difference in head of about 8 feet based on recent averages (3,701 and 3,709 feet elevation, respectively); at the time these wells were drilled, they also exhibited a difference of 8 feet (3,711 and 3,719 feet elevation). The difference in head between these two closely spaced wells is likely the result of minor differences in lithology and permeability of the aquifer.

Well 695. The mean water elevation for this well is 3,632 feet and is correct as presented on Figure 2.7-14 of the NRC TR. The pressure has a mean average of 12 pounds per square inch (psi) with individual measurements that range from 12.7 to 13.8 psi. As in all free-flowing wells, psi is converted to feet by the formula:

$$\text{Feet H}_2\text{O above measuring point} = \text{psi} \times (144 \text{ in}^2/\text{ft}^2) \times (\text{ft}^3/62.43 \text{ lb}). \quad (1)$$

Lakota Aquifer

Well 8002. This Lakota stock well has an average elevation of 3,578 feet as presented on Figure 2.7-15 of the TR. This value was not used while generating the water level contours for several reasons. First, this well is a free-flowing artesian that was shut in during measurements; although no leaks were visible, it is possible that this well could not completely be shut in, as it is an older well with multiple fittings at the surface. Over the measurement time interval (September 2007 through February 2009), only 3 pressure measurements were made: 13, 15, and 14.65. Based on field notes, the value of 14.65 psi should be discarded as one of the lines froze during the stabilization period and the sampler was required by the landowner to open the valve to prevent well damage. It is also believed that the other two readings were potentially taken before the well had completely stabilized.

In generating the water level contours, Well 608 to the west was considered to have more reliable readings as this well is nonartesian and was measured with a water level tape. Water levels at Well 608 indeed exceeded estimates at Well 8002; that is unexpected and unlikely given the water gradient decreases toward the southwest. Water level data for Well 696, although not used in the generation of the original potentiometric surface, have an average value of 3,639 feet elevation; this value is extremely close to the potentiometric surface generated by ignoring the data from Well 8002. Therefore, it is our position that this decision to not use data from Well 8002 was sound. It is advisable to verify completion of this well and obtain additional water level measurements.

Well 615. Based on six measurements, the mean potentiometric surface at Well 615 is correctly reported at 3,690 feet elevation. A well completion report for this well is available to verify this well is completed into the Lakota.

— DRAFT —

Well 609. There are a total of 11 measurements for this well, all within ± 2 feet of each other. The value of 3,690 feet elevation on the existing potentiometric surface map is correct. A well completion report for this well is available to verify this well is completed into the Lakota. In addition, Well 610 (completed in the Fall River) is immediately adjacent to this well and has a comparable water level of 3,693 feet.

Well 689. This well was recently installed by Powertech as a monitoring well for the Dewey pump test. It is screened for 15 feet in the upper Lakota Formation. A total of 11 pressure measurements were collected from this well, ranging from 23 to 25 psi. The mean water level of 3,684 feet presented on the potentiometric surface is correct according to our database and field records.

Well 38. Based on the TVA EIS, this stock well is located in Sec. 33, T6S, R1E with a depth of 550 feet and completed in the Lakota. However, data from a well completion report (Figure 2) indicate this well has a depth of 494 feet. The surface elevation at this well is roughly 3,630 feet, making the depth of this well have an elevation of 3,136 feet (assuming the well completion report is correct). Based on structure contour maps, the bottom of the Fall River (top of Fuson) is around 3,130 feet. Based on the depth reported on the well completion form and the structural contour information based on exploration boreholes, this well is now believed to be completed in the Fall River Formation and not the Lakota Formation. The mean water elevation of 3,644 feet measured at this well could be used in the future to slightly modify the potentiometric surface for the Fall River Formation; the measured value is not unreasonable for the Fall River. Since this is a free-flowing well, it is also possible the water level could be higher than measured if shut in for a longer period of time. If potentiometric surfaces are redrawn in the near future, it is recommended to not include Well 38 on the Lakota surface. It is also recommended to log this well to verify completion.

Task 3. Generate Map of Potentiometric Surfaces That has Wells Labeled by Well I.D.

Existing potentiometric surfaces for the Fall River, Lakota, and Unkpapa Aquifers are presented in Figures 3 through 6. Contours have not been modified from previous versions. Figure 5 is a revised potentiometric map of the Lakota that has wells not used in generating contours removed to reduce confusion.

Task 4. Compile Water Level Data and Completion Information Into a Table

Tables 3 through 8 contain the field water level measurements and calculated water table elevations. Tables 3 and 4 contain data for the Inyan Kara Aquifers, Tables 5 and 6 contain alluvial aquifer information, and Tables 7 and 8 contain water level information on the Unkpapa Aquifer.

— DRAFT —

RSI-1853-10-035

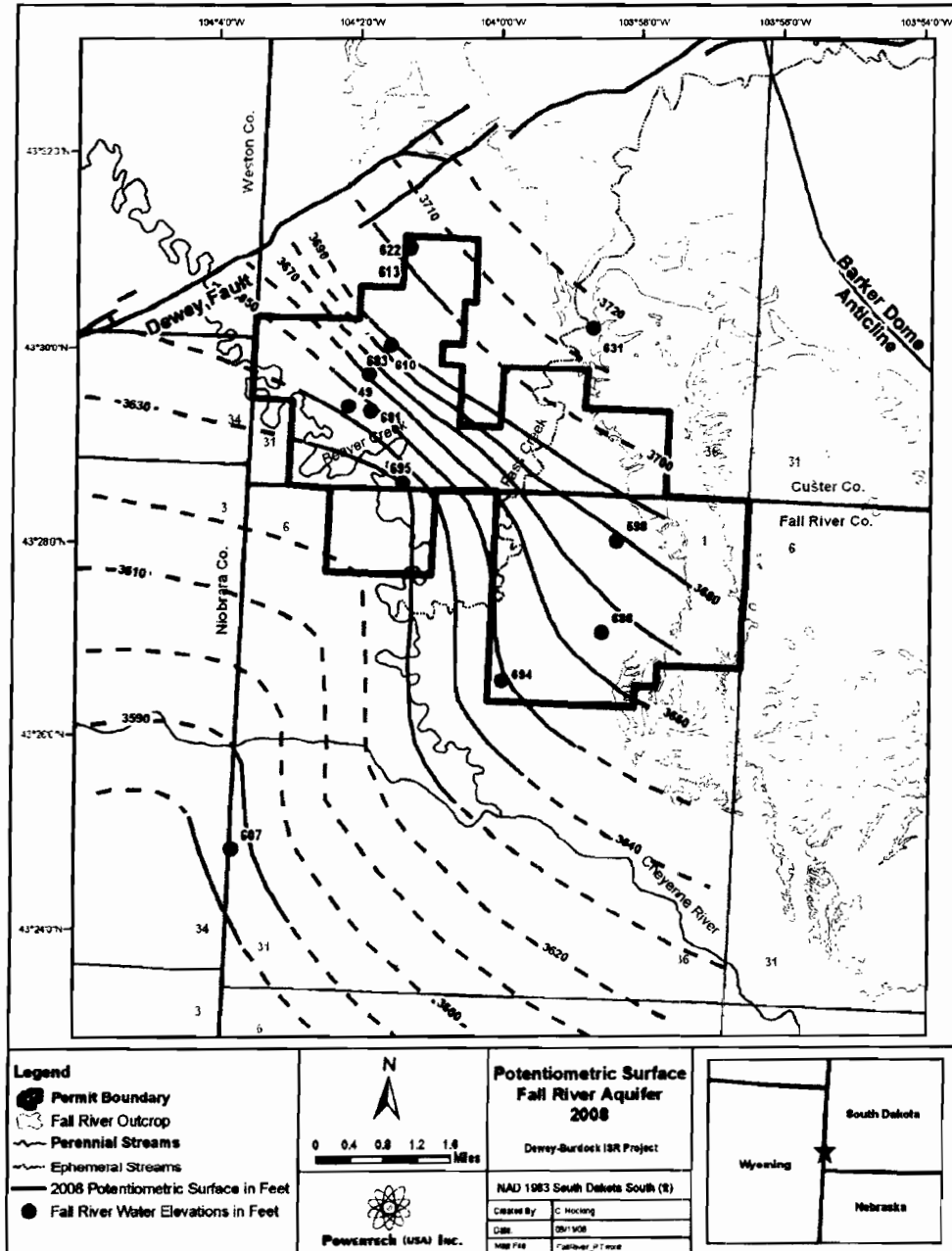

Figure 3. Fall River Aquifer Potentiometric Map With Wells Labeled by Hydro I.D.

— DRAFT —

RSI-1853-10-036

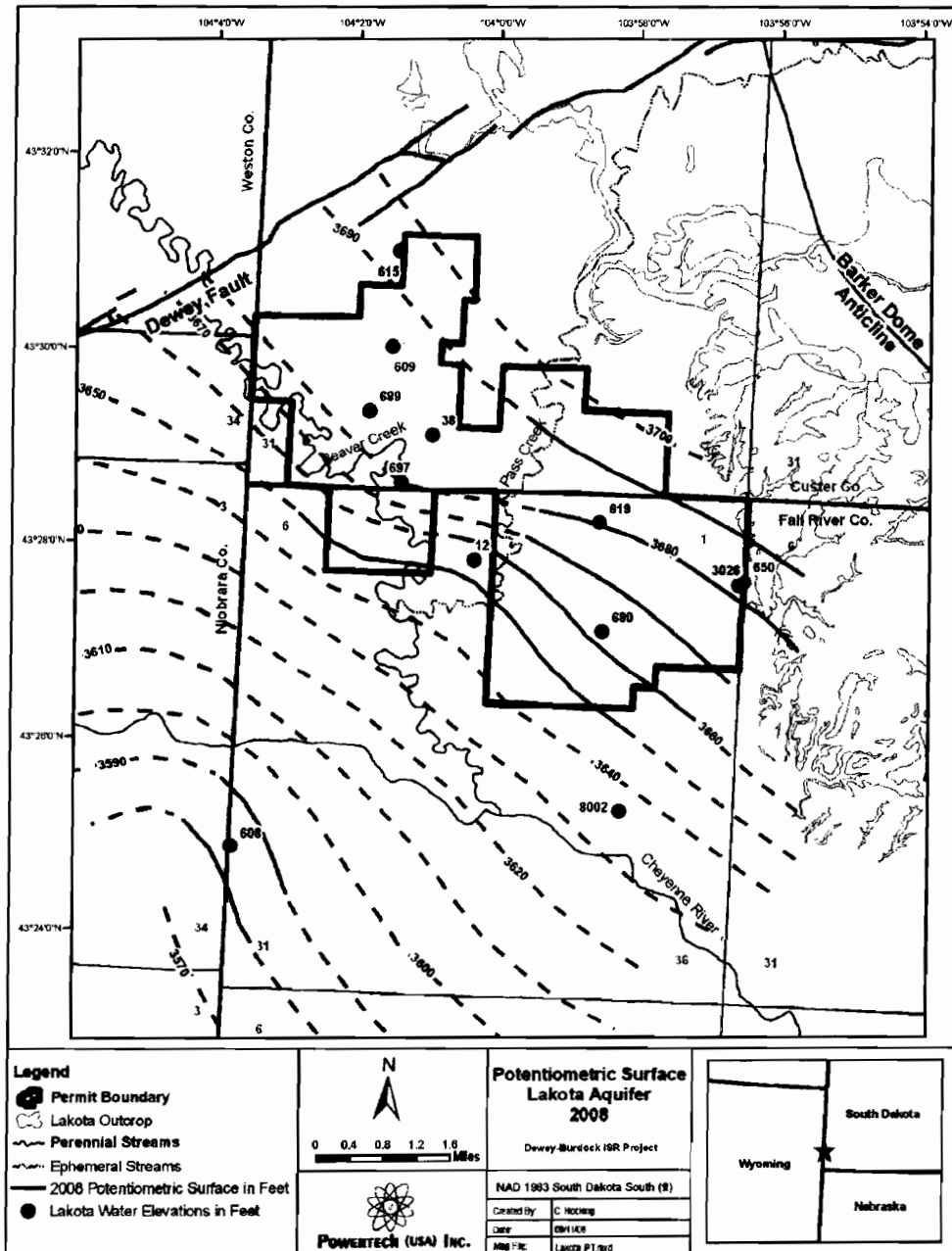

Figure 4. Lakota Aquifer Potentiometric Map With Wells Labeled by Hydro I.D.

— DRAFT —

RSI-1853-10-041

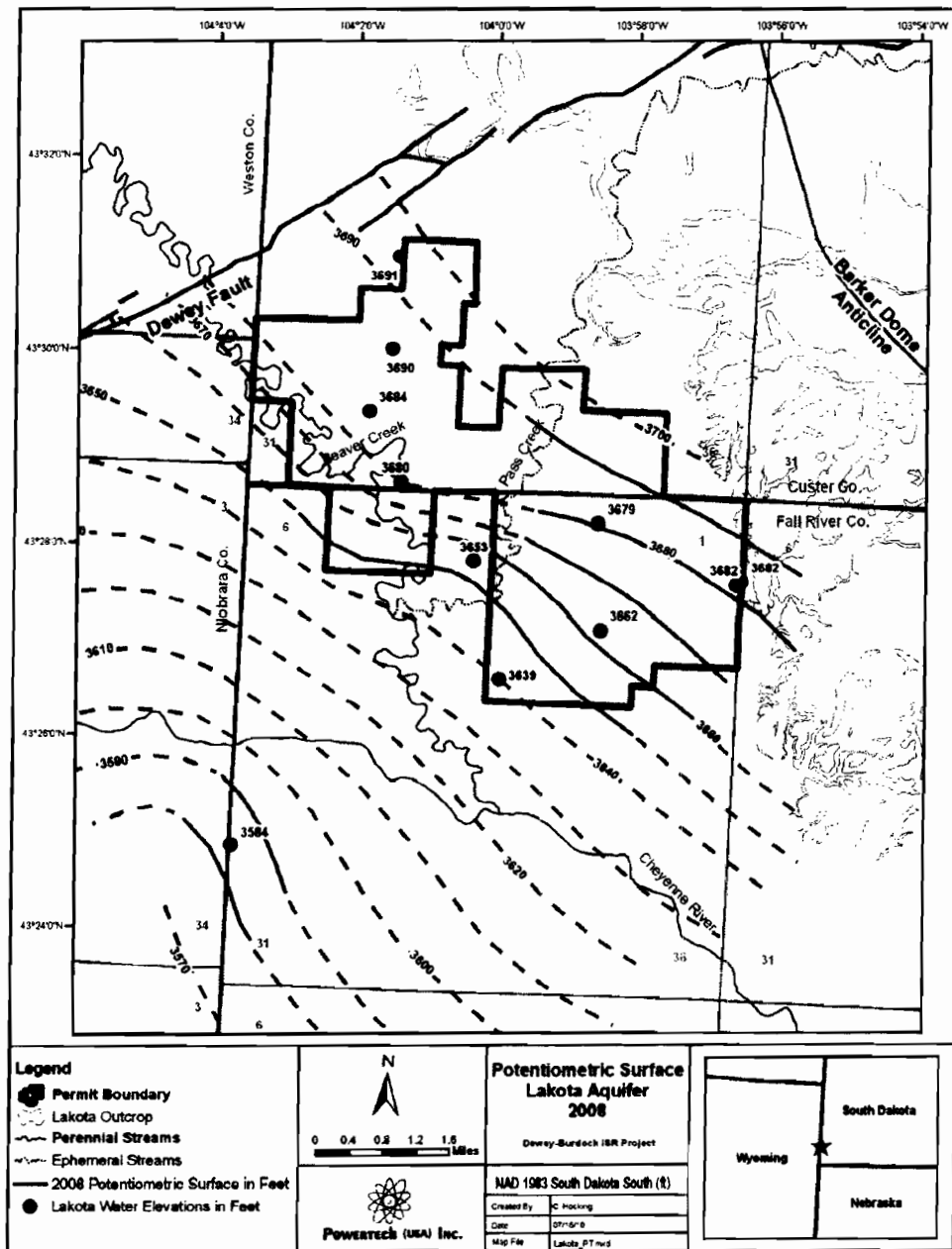

Figure 5. Revised Lakota Aquifer Potentiometric Surface. This map has removed Wells 38 and 8002 and added Well 696 to reflect data that were actually used to generate the contour map.

— DRAFT —

RSI-1853-10-037

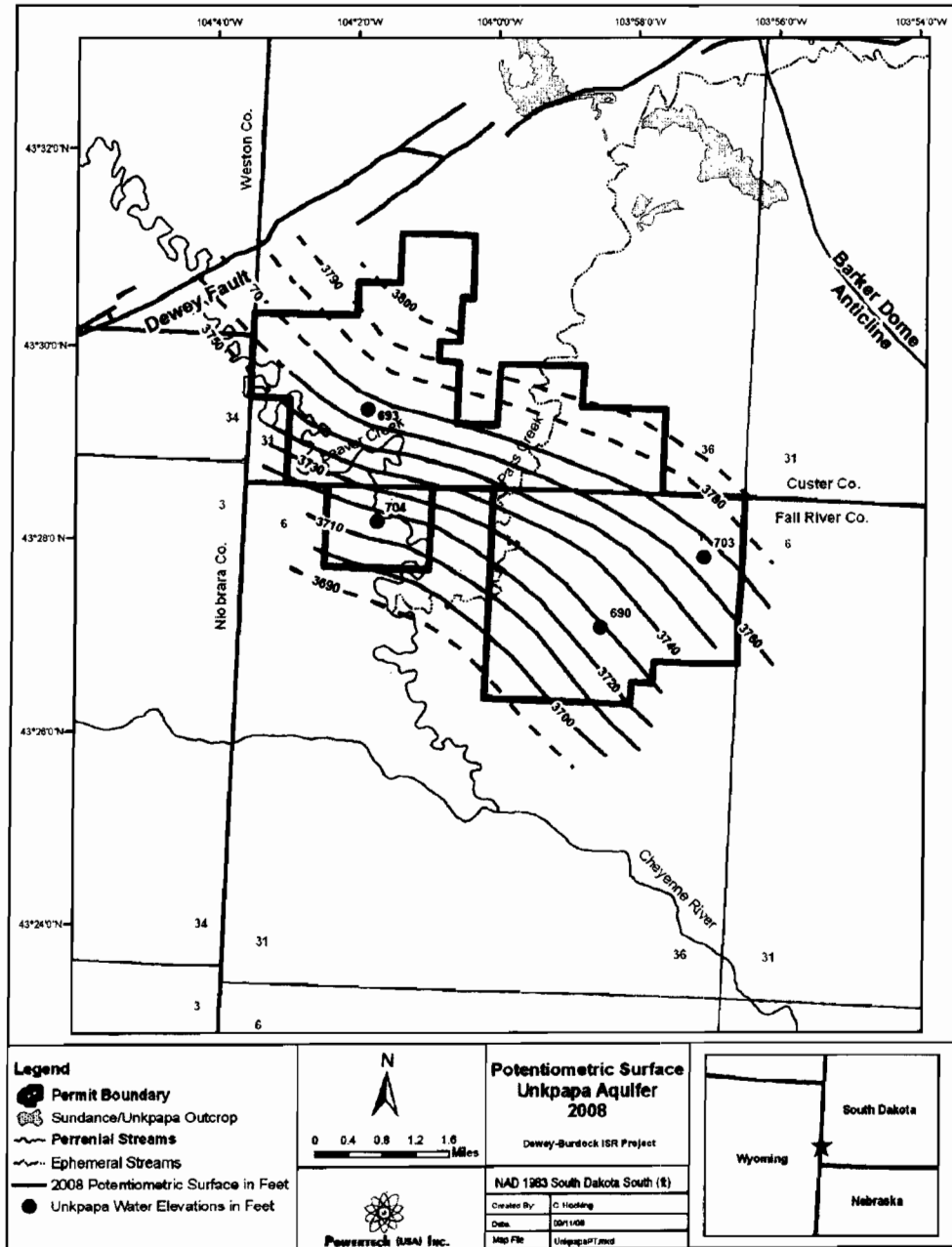

Figure 6. Unkpapa Aquifer Potentiometric Map With Wells Labeled by Hydro I.D.

— DRAFT —



3.2067 ft/psi
 3.28 ft/m
 Wae
 Throughout

Table 4. Inyan Kara Water Level Measurements in Elevation Above Sea Level

Hydro ID or Name Code	12	38	49	507	608	609	610	613	614	615	619	622	628	631	650	668	660	661	665	668	669	666	695	697	698	3026	8002	8003			
Formation	Lakota	Lakota	Fall River	Fall River	Lakota	Lakota	Fall River	Fall River	Fusion Shale	Lakota	Lakota	Fall River	Inyan Kara	Fall River	Lakota	Inyan Kara	Lakota	Fall River	Fall River	Fall River	Lakota	Lakota	Fall River	Fall River	Lakota	Lakota	Lakota	Unknown			
Permeation Depth	805	494	600	unknown	unknown	1000	680	580	620	800	280	430	unknown	80	unknown	unknown	426	600	650	595	255	730	392	508	662	205	196	Unknown			
Screened Interval	unknown	unknown	unknown	unknown	unknown	503-698	630-672	504-580	SS	SS	503-590	SS	SS	SS	SS	SS	SS	SS	SS	SS	SS	SS	SS	SS	SS	SS	SS	SS	Unknown		
SubSurface (SS) or Free-Flowing (FF)	FF	FF	FF	SS	SS	SS	SS	SS	SS	SS	SS	SS	SS	SS	SS	FF	FF	FF	FF	FF	FF	FF	FF	FF	FF	FF	SS	Unknown			
Targeted Measurement Frequency	Quarterly	Quarterly	Quarterly	Monthly	Monthly	Monthly	Monthly	Quarterly	Quarterly	Monthly	Quarterly	Monthly	Quarterly	Quarterly	Quarterly	Quarterly	Monthly	Monthly	Once	Once	Monthly	Monthly	Monthly	Monthly	Monthly	Monthly	Monthly	Quarterly	Quarterly		
Surveyed Well Casing Elevation, ft	3641.74	3620.86	3610.55	3609.35	3700.67	3704.55	3736.53	3741.16	3741.09	3700.12	3753.26	3731.99	3745.37																		
Stick Up (Well Casing Mark), ft	-0.58			-0.37	-0.08	-3.10	-0.48	-0.45	-1.11	-0.54	0.06	-0.46	-0.56																		
Surveyed Control Point Elevation, ft		3637.46	3618.86																												
Stick Up (Control Point), ft		-2.16																													
Calculated Measuring Point Elevation, ft	3641.72	3638.64	3618.86	3610.62	3609.34	3700.77	3705.34	3727.38	3741.27	3741.54	3700.12	3753.74	3732.55	3745.76	3821.62	3625.31	3701.68	3627.14	3663.53	3627.67	3701.30	3627.39	3606.00	3600.63	3609.90	3609.25	3714.48	3620.68	3644.85	3644.59	
Units	feet	feet	feet	feet	feet	feet	feet	feet	feet	feet	feet	feet	feet	feet	feet	feet	feet	feet	feet	feet	feet	feet	feet	feet	feet	feet	feet	feet	feet	feet	
2007-09-25		3641.25	3640.34				3693.47	3692.81	3701.30	3700.14	3691.00																				
2007-09-26																															
2007-09-27	3653.72										3679.13		3695.72																		
2007-10-02																															
2007-10-09																															
2007-10-26							3684.35		3680.52	3692.81																					
2007-11-09	3653.26	3641.67	3641.93	3641.61			3690.27	3690.12																							
2007-11-19											3701.07	3700.07	3691.85																		
2007-11-27																															
2007-02-11							3690.21	3693.83																							
2008-01-11											3701.58	3700.06	3690.42																		
2008-01-30							3689.85	3694.98																							
2008-02-03																															
2008-02-05																															
2008-02-20							3688.25	3694.90																							
2008-02-21							3689.55	3692.93	3701.08	3700.01	3691.85																				
2008-03-06																															
2008-03-09							3684.90																								
2008-03-24																															
2008-03-30																															
2008-04-01																															
2008-04-21																															
2008-04-22																															
2008-04-29							3585.21	3584.19	3689.81	3692.54																					
2008-05-08																															
2008-05-15																															
2008-05-19																															
2008-05-21																															
2008-05-28																															
2008-05-29																															
2008-05-30																															
2008-06-01																															
2008-06-09							3585.27	3584.45																							
2008-06-10																															
2008-06-22																															
2008-06-24																															
2008-06-25																															
2008-06-30	3652.22	3643.95	3635.89																												
2008-07-01																															
2008-07-13																															
2008-07-14																															
2008-07-28							3585.49	3584.47	3688.96	3692.22																					
2008-08-19																															
2008-08-20																															
2008-09-22																															
2008-09-23																															
2008-09-30																															
2008-10-26																															
2008-10-21																															
2008-11-17																															
2008-12-16																															
2009-01-17																															
2009-01-19																															
2009-01-26																															
2009-02-23																															
2009-02-24																															
n	3	3	4	4	8	11	11	6	16	2	13	7	6	11	1	1	1	1	1	1	1	1	1	1	1	1	1	1	1		
Average	3653.09	3644.07	3640.92	3585.09	3584.37	3689.67	3692.86	3701.24	3700.02	3690.36	3679.16	3709.90	3695.87	3714.92	3682.15	3650.79	3661.59	3641.78	3659.01	3645.66	3663.05	3647.93	3631.81	3639.07	3682.12	3679.84	3681.98	3577.64	3563.35		

Table 5. Alluvial Water Level Measurements in Feet Below Measuring Point

Hydro I.D. or Hydro Code	675	676	677	678	679
Targeted Measurement Frequency	Monthly	Monthly	Monthly	Monthly	Monthly
Measuring Point	top of well casing	top of well casing	top of well casing	top of well casing	top of well casing
Distance from Measuring Point to Ground (ft)	2.3	2.4	2.3	2.3	2.3
Approximate Land Elevation From Topographic Map (ft)	3,491	3,662	3,570	3,591	3,717
Calculated Measuring Point Elevation (ft)	3,493.3	3,664.4	3,572.3	3,593.3	3,719.3
Date	ft below measuring point				
9/28/2007	-11.18	-20.14	-11.51	-12.1	-33.6
10/26/2007	-11.04	-20.3	-11.35	-11.73	-33.83
11/9/2007	-10.99	-20.3	-11.25	-11.45	-33.85
11/14/2007					-33.85
11/27/2007	-10.99	-20.37	-11.12	-11.22	
12/11/2007	-10.82	-20.4		-11.15	-33.88
1/11/2008	-10.6	-20.44			-33.87
1/30/2008			-10.17	-10.82	
2/3/2008					-33.88
2/5/2008	-10.37	-20.5	-10.1	-10.81	
3/6/2008	-10.045	-20.53	-9.9	-10.75	-33.93
4/29/2008	-10.42	-20.6	-9.63	-10.38	
5/18/2008					-34.02
6/30/2008		-20.65	-9.45	-10.95	-34.03

— DRAFT —

Table 6. Alluvial Water Level Measurements in Elevation Above Mean Sea Level

Hydro ID or Hydro Code	675	676	677	678	679
Formation	Alluvial	Alluvial	Alluvial	Alluvial	Alluvial
Subsurface (SS) or Free-Flowing (FF)	SS	SS	SS	SS	SS
Depth (ft)	14-4	22.5	14.5	14.5	39
Screened Interval (ft)	4-14	12-22	4-14	4-14	29-39
Targeted Measurement Frequency	Monthly	Monthly	Monthly	Monthly	Monthly
Measuring Point	top of well casing	top of well casing	top of well casing	top of well casing	top of well casing
Distance from Measuring Point to Ground (ft)	2.3	2.4	2.3	2.3	2.3
Approximate Land Elevation From Topographic Map (ft)	3,491	3,662	3,570	3,591	3,717
Calculated Measuring Point Elevation (ft)	3,493.3	3,664.4	3,572.3	3,593.3	3,719.3
Date	ft above mean sea level				
9/28/2007	3,482.1	3,644.3	3,560.8	3,581.2	3,685.7
10/26/2007	3,482.3	3,644.1	3,561.0	3,581.6	3,685.5
11/9/2007	3,482.3	3,644.1	3,561.1	3,581.9	3,685.5
11/14/2007					3,685.5
11/27/2007	3,482.3	3,644.0	3,561.2	3,582.1	
12/11/2007	3,482.5	3,644.0		3,582.2	3,685.4
1/11/2008	3,482.7	3,644.0			3,685.4
1/30/2008			3,562.1	3,582.5	
2/3/2008					3,685.4
2/5/2008	3,482.9	3,643.9	3,562.2	3,582.5	
3/6/2008	3,483.3	3,643.9	3,562.4	3,582.6	3,685.4
4/29/2008	3,482.9	3,643.8	3,562.7	3,582.9	
5/18/2008					3,685.3
6/30/2008		3,643.8	3,562.9	3,582.4	3,685.3
Mean	3,483	3,644	3,562	3,582	3,685

— DRAFT —

Table 7. Unkpapa Water Level Measurements in Feet

Hydro LD. or Hydro Code	690	693	703	704
Targeted Measurement Frequency	Once	Once	Once	Once
Measuring Point	top of casing	top of casing	top of casing	top of casing
Distance from Measuring Point to Ground				2
Surveyed Well Casing Elevation (ft)	3,700.04	3,627.27		
Stick Up (Well Casing Mark) (ft)				
Surveyed Control Point Elevation (ft)	3,699.59	3,626.31		
Stick Up (Control Point) (ft)	0.41			
Calculated Measuring Point Elevation (ft)	3,699.18	3627.27	3,877 ^a	3,599 ^a
Date	ft above (+) or below (-) measuring point			
5/14/08	29.15	135.77		
5/21/08			-109.96	
5/28/08	30.65			
5/30/08				116.5
6/24/08			-109.4	

(a) Wells were not surveyed. Elevation estimated from topographic map.

Task 5. Generate an Explanation of Water Level Measurement Feasibility for the Wells Listed in the NRC Comments

The wells listed in the NRC review of the TR and an explanation of the feasibility of obtaining a water level measurement from those specific wells is included in Table 9. Figures 7 and 8 display these wells for possible inclusion alongside those wells that are in the current water level monitoring plan. For many of these wells, water level measurements were not easily obtained, but could be obtained with additional work such as pulling a pump and shutting in a well for a period of time. At this time, it is assumed that Powertech will be conducting further field investigations into this matter based on RESPEC's cursory review.

— DRAFT —

Table 8. Unkpapa Water Level Measurements in Elevation Above Sea Level

Hydro LD. or Hydro Code	690	693	703	704
Formation	Unkpapa	Unkpapa	Unkpapa	Unkpapa
Subsurface (SS) or Free-Flowing (FF)	FF	FF	SS	FF
Depth (ft)	623	930	525	955
Screened Interval (ft)	621-631	910-930	475-525	915-955
Targeted Measurement Frequency	Once	Once	Once	Once
Measuring Point	top of well casing	top of well casing	top of well casing	top of well casing
Distance from Measuring Point to Ground				2
Approximate Land Elevation from topographic map (ft)			3,877	3,599
Calculated Measuring Point Elevation (ft)	3,699.2	3,627.3	3,877	3,599
Date	ft above mean sea level			
5/14/08	3,728.3	3,763.0		
5/21/08			3,767.0	
5/28/08	3,729.8			
5/30/08				3,715.5
6/24/08			3,767.6	
Mean	3,729	3,763	3,767	3,716

Task 6. Review the Water Rights, Well Completion, and Water Quality for the Well North of Kennobbie's Ranch to Determine Aquifer

Well 4, a stock well located in SESE Sec. 15, T7S, R1E, was brought into question as to which aquifer the well is completed in. A well log indicates this well was originally drilled as an oil exploration well (API# 5093) into the Minnelusa Formation to a depth of 2,264 feet. This log (Figure 9) also indicates the well was plugged and abandoned. RESPEC was not able to find any water rights or well completion information describing how this well was completed as a water well. However, information in Table 2.5.2-1 of the TVA EIS report describes this well (D-19) as being 2,264 feet deep, coinciding with the original drilling depth into the Minnelusa, and with a water level of 3,580 feet elevation.

— DRAFT —

Table 9. Wells for Possible Inclusion in Water Level Measurement Plan (Page 1 of 3)

Aquifer	Well	Free Flowing or Subsurface	Reason for not Measuring Originally	Could be Measured With Minimal Additional Effort	Other Comments
Fall River	7	Unknown	Domestic can not measure without pulling pump	Yes	There is a .las file for this well, so it must be possible to measure
Fall River	8	FF	Domestic can not measure without pulling pump and shutting in for period of time	Maybe	Requires further investigation to determine feasibility
Fall River	17	SS	Stock well would need pump pulled and to stop being use to stabilized	Maybe	Requires further investigation to determine feasibility
Fall River	18	FF	Domestic can not measure without pulling pump and shutting in for period of time	Maybe	Requires further investigation to determine feasibility
Fall River	20	Unknown	Domestic can not measure without pulling pump and shutting in for period of time	Maybe	Requires further investigation to determine feasibility
Lakota	1	FF	Could not be sealed for psi measurement because of leaks caused by corrosion and age	No	Could only be measured if well casing is repaired
Lakota	2	FF	Could not be sealed for psi measurement because of leaks caused by corrosion and age	No	Could only be measured if well casing is repaired
Lakota	13	Unknown	Domestic can not measure without pulling pump; well is no longer used as resident moved	Maybe	Requires further investigation to determine feasibility

— DRAFT —

Table 9. Wells for Possible Inclusion in Water Level Measurement Plan (Page 2 of 3)

Aquifer	Well	Free Flowing or Subsurface	Reason for not Measuring Originally	Could be Measured With Minimal Additional Effort	Other Comments
Lakota	14	SS	Difficult surface access	Maybe	Requires further investigation to determine feasibility
Lakota	16	SS	difficult surface access because of fittings, domestic well would have to be shut in for period	Maybe	Requires further investigation to determine feasibility
Lakota	42	Unknown	Domestic could not measure without pulling pump. Well has been revamped and completed in the Fall River Formation (?)	Yes	We are not sure when or to what formation this well is now completed in.
Lakota	51	FF	Surface casing in poor condition, leaking	No	This well is not measurable under the present condition
Lakota	96	FF	Domestic can not measure without pulling pump and shutting in for period of time	Maybe	Requires further investigation to determine feasibility
Lakota	115	FF	Domestic can not measure without pulling pump and shutting in for period of time; also not measured because of location north of Dewey Fault	Maybe	Requires further investigation to determine feasibility
Lakota	147	SS	Not measured because of location north of Dewey Fault	Yes	This is a 1-inch piezometer that could easily be measured
Lakota	510	FF	Difficult access, would require shut	Maybe	Requires further investigation to determine feasibility

— DRAFT —

Table 9. Wells for Possible Inclusion in Water Level Measurement Plan (Page 3 of 3)

Aquifer	Well	Free Flowing or Subsurface	Reason for not Measuring Originally	Could be Measured With Minimal Additional Effort	Other Comments
Lakota	620	SS	Stock well would need pump pulled and to stop being use to stabilized	Maybe	This well has a good potential for measurement
Lakota	696	FF	Could not be measured at time of potentiometric map generation because of poor or cracked valve fittings. Valves were replaced and RESPEC has record of six measurements from 9/22/08 to 2/22/09	Yes, and it has been	
Lakota	697	FF	This well was inadvertently left off potentiometric maps. It has been measured 12 times between 3/30/08 and 2/24/09.	Yes, and it has been	
Lakota	7002	FF	Because of the age of this well, it is believed that pressurizing may cause a line to rupture	No	Could only be measured if well casing is repaired

This well was sampled three times in 1979 by TVA and once by RESPEC in 2008. Data results are presented in Table 10. In comparison to nearby Well 7 and Well 7002, this well has nearly twice the value of chemical conductivity and sulfates. Conductivity and sulfate values observed at this well are dissimilar from other Inyan Kara wells in the area as well, but values are more compatible with expected water quality for the Minnelusa Aquifer. A detailed statistical comparison of water quality was not conducted at this time.

Based on the available information, it is now reasonable to believe Well 4 may be completed in the Minnelusa Aquifer. It is recommended to try to log this well with a borehole viewer to confirm the completion of this well.

If you have any further questions or need further explanation of these items, please do not hesitate to contact me.

CMH:llf

— DRAFT —

RSI-1853-10-042

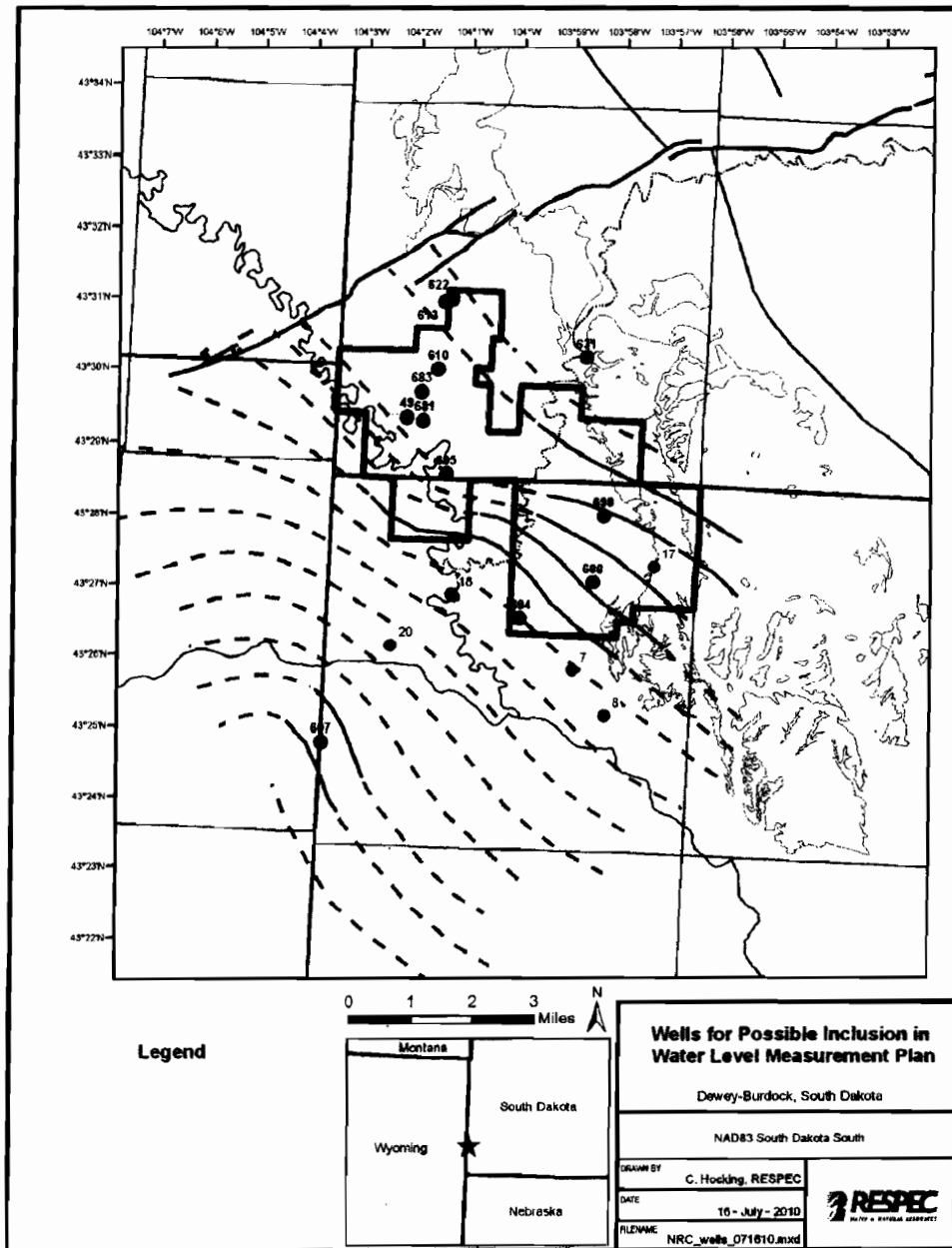

Figure 7. Fall River Aquifer Wells for Possible Inclusion in the Water Level Measurement Plan. Black dots are wells in the current monitoring plan while blue dots are wells not currently included.

— DRAFT —

RSI-1853-10-043

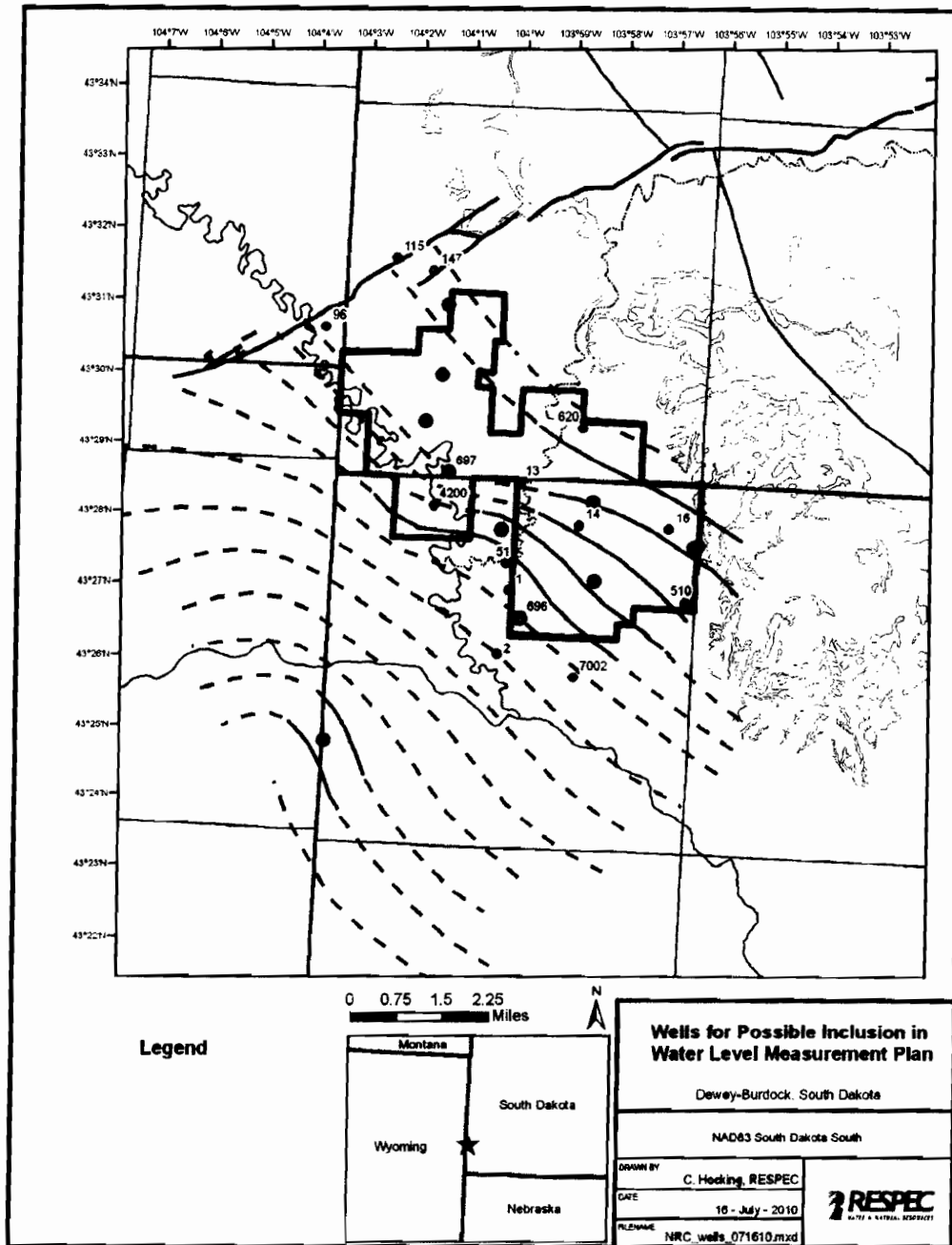
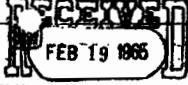

Figure 8. Lakota Aquifer Wells for Possible Inclusion in the Water Level Measurement Plan. Black dots are wells in the current monitoring plan while blue dots are wells not currently included.

— DRAFT —

RSI-1853-10-038



STATE WATER RESOURCES COMM.
PERRE SOUTH DAKOTA

State Pub. Co., Place

APPLICATION FOR PERMIT TO:

<input checked="" type="checkbox"/> DRILL	<input type="checkbox"/> DEEPEN	<input type="checkbox"/> PLUG BACK	NAME OR LEASE NAME
<input type="checkbox"/> OIL WELL	<input type="checkbox"/> GAS WELL	<input type="checkbox"/> SINGLE BONE	Peterson
		<input type="checkbox"/> MULTIPLE BONE	WEL. NO.
			61 (44-15)
APPLICANT			FIELD AND POLE, OR WELDCAT
The Superior Oil Company			
ADDRESS			NO. ACRES IN LEASE
F. O. Box 200, Casper, Wyoming			2946.00
ELEVATION (at top hole or adjacent corner of the legal subdivision)			N 1/4 28E 17W 10N
640' TEL & 640' TEL Sec. 11-7E-1E			SE SE 15-7E-1E
			COUNTY
			Fall River
NAME AND ADDRESS OF SURFACE OWNER		ELEVATION BENEATH	NO. OF WELLS PER
F. A. Peterson Edgemont, South Dakota		2574 S.L.	
		PROPOSED DEPTH 2500'	ROVARY OR CABLE TOOLS Rotary
NAME AND ADDRESS OF CONTRACTOR		APPROPRIATE DATE WELL START	
Unknown		2-22-65	

IF LEASE PURCHASED WITH ANY WELLS BOILED, FROM WHICH PURCHASED OILS AND GASES

PROPOSED CASING AND CEMENTING PROGRAM					
SIZE OF HOLES	SIZE OF CASING	WEIGHT PER FOOT	HOW SE. DRILLED	DEPTH	SACKS OF CEMENT
18-1/2"	8-1/2"	225	Rot	500	500

DESCRIBE PROPOSED OPERATIONS, IF PROPOSAL IS TO DEEPEN OR PLUG BACK, GIVE DATA ON PRESENT PRODUCTIVE ZONE AND PROPOSED NEW PRODUCTIVE ZONE. GIVE BELOW COT PREVENTER PROGRAM IF ANY

- (1) The Superior Oil Company proposes to drill a 2500' 1st Lee Sand test at the above location.
- (2) Will set 8-1/2" cas. at 500' & cont. to surface.
- (3) Will drill 7-7/8" hole to total depth.
- (4) Will catch 30' samples from base of surface to TD.
- (5) Expect to core & test the 1st Lee Sand plus any other zones that have significant shows.
- (6) Will run Dual Induction-Logging & GOR logs from TD to base of surf. cas.
- (7) Should commercial production be encountered, 8-1/2" casing will be cemented through the productive zone.

SIGNED: *[Signature]* TITLE: District Engineer DATE: 2-11-65

DO NOT WRITE BELOW THIS LINE

PERMIT NO. 382 CHECKED BY: *[Signature]* 2/17/65

APPROVAL DATE: February 18, 1965 *[Signature]* District Engineer

COMMENTS:

COMPLETE SET OF SAMPLES AND CORES IF TAKEN. SHOW BE SUBMITTED.

SAMPLES AND CORES IF TAKEN. SHOW DEPTH MUST BE SUBMITTED.



INSTRUCTIONS

General: This form is designed for submitting proposals to perform certain well operations, as indicated, on all types of lands and leases for appropriate action by either a Federal or a State agency or both, pursuant to applicable Federal and/or State laws and regulations. Consent of the Federal or State agencies or both, is required for the proposed operations to be carried out.

If the proposal is to re-work the same reservoir in a different subsurface location or to a new reservoir, use this form with appropriate notation.

If the well is to be, or has been, directionally drilled, so state and show by attached sheets, if necessary, the coordinate location of the hole in any present or prospective productive zone.

File 5 copies of this form with Director, Oil & Gas Board, Pierre.

(*Sample location 60W South and 60W East of the Northwest Corner of Section 16.)

Figure 9. Well Completion Report for Well I.D. #4 (Page 1 of 3).

— DRAFT —

RSI-1853-10-039

9-063
(December 1949)

UNITED STATES
 DEPARTMENT OF THE INTERIOR
 GEOLOGICAL SURVEY
 WATER RESOURCES DIVISION

No. D 7-1-15 dd (center)

SCHEDULED

OTHER NOS. Superior #1 Peterson
244-15

WELL LOG

State S. Dak. County Tall Pine Subarea _____

Owner Superior Oil Company Lease #1 Peterson (44-15)

Location SEE SPECIAL LOG FILE FOR (TP 2264 f2)

MORE INFORMATION

660ft north and 660ft west of the southeast cor-
 ner

Drilled by Borghart Address _____

Date 2-19 to 3-5-65 Casing diam. plugged & abandoned Land-surf. alt. 3585 Kelly bush
3576

Source of data PI's, sonic, caliper, G-rug, dual induction, and composite induction log.
 (Enter type of well, perforations, yield, and drawdown at end of log)

CORRELATION	MATERIAL	THICKNESS (feet)	DEPTH (feet) PL
	Dakota		195
?	Skull Creek		
127	Inyan Kara		
	Lakota		371
517	Morrison		
288	Sunbonae		771
1040 (P)	Spearsfish		
1522	Minnekahta		1518
1555	Opache		1557
1631	Minnelusa		1645
	Red Sparker		2108
2224	T.D.		
	<u>Correl. 2175 to 2221 ft</u>		

RECORD BY _____ DATE _____ SHEET _____ OF _____
 51753
 GPO 850-852

Figure 9. Well Completion Report for Well I.D. #4 (Page 2 of 3).

— DRAFT —

RSI-1853-10-040

SI-STATE COMPANY
NEWCASTLE, WYOMING

N. W. Corner			N. E. Corner
		WELLSITE SE 1/4 SE 1/4 Gr. Elev. 3576.5 ft.	
S. W. Corner			S. E. Corner

I, Lorenza T. Price of Newcastle, Wyoming, Certify
 that in accordance with a request from J. P. Dicks
 of Casper, Wyoming for The Superior Oil Company
P. O. Box 200, Casper, Wyoming
 I made a survey (date) February 3 1955
 for the location and elevation of the Petersen No. 1 (44-15) oil
wellsite
 As shown on above map, the well site is in center SE 1/4 SE 1/4
 Section 15, Township 7 South Range 1 East WYOMING
Fall River County, WYOMING Elevation is 3576.5 feet
above mean sea level before doring.



 Licensed Surveyor No. 1911

Figure 9. Well Completion Report for Well I.D. #4 (Page 3 of 3).

— DRAFT —

Table 10. Water Quality Data for Well 4 (Page 1 of 4)

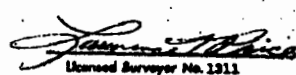
	1979-06-15	1979-08-15	1979-09-12	2008-02-12
ALKALIN	80		181	88
ANIONS				53.3
As	0.01		0.01	
B	1		1	
BALANCE	-57.3		-54.9	-2.6
BICARB	73		220	107
B-TDS				1.02
Ca	349		477	
CARB	12		0	5
CATIONS				50.6
Cl	28		26	26
Cond, Field	4,550		4,500	
CONDUCT Lab				4,400
C-SOLIDS				3,600
D-Ag				0.005
D-Al				0.1
D-As				0.001
D-B				0.7
D-Ba				0.1
D-Ca				241
D-Cd				0.005
D-Cr				0.05
D-Cu				0.01
D-Fe				0.03
D-GALPHA				3.5
D-GBETA				14.4
D-GGAMMA				20

— DRAFT —

Table 10. Water Quality Data for Well 4 (Page 2 of 4)

	1979-06-15	1979-08-15	1979-09-12	2008-02-12
D-Hg				0.001
D-K				7.8
D-Mg				87
D-Mn				0.07
D-Mo				0.1
D-Na				716
D-Ni				0.05
DO				
D-Pb				0.001
D-Pb210				1
D-Po210				2.7
D-Ra226				1.1
D-Se				0.001
D-SeIV				0.001
D-SeVI				0.001
D-Si				10.2
D-SOLIDS	4,733		4,117	3,700
D-Th				0.005
D-Th230				0.2
D-U				0.0004
D-V				0.1
D-Zn				0.01
F				0.4
Fe	1.68		1.59	
F-pH				7.83
hardness	1,459		1,392	
K	15		14	

— DRAFT —

Table 10. Water Quality Data for Well 4 (Page 3 of 4)

	1979-06-15	1979-08-15	1979-09-12	2008-02-12
L-pH	8		7.7	7.94
Mg	143		49	
Mn	0.12		0.08	
N	0.64		0.22	
Na	920		743	
NH3				0.8
NO2				0.1
NO3				0.1
ORP				120
Pb	0.05		0.05	
PO4	0.01		0.01	
SAR				10
Se	0.01		0.01	
SiO2	9.4		8.6	
SO4	3,230		2,700	2,440
S-Pb210				1
S-Po210				1
S-Ra226				0.7
S-Th230				0.2
S-U				0.0003
T-Ag				0.005
T-As				0.001
T-B				0.6
T-Ba				0.1
T-Be				0.001
T-Cd				0.005
T-Cr				0.05

— DRAFT —

Table 10. Water Quality Data for Well 4 (Page 4 of 4)

	1979-06-15	1979-08-15	1979-09-12	2008-02-12
T-Cu				0.01
TEMP				11.92
T-Fe				1.32
T-Hg				0.001
T-Mn				0.06
T-Mo				0.02
T-Ni				0.05
T-Pb				0.001
T-Pb210				
T-Po210				
T-Ra222				908
T-Ra226		0.11		
T-Sb				0.003
T-Se				0.002
T-Sr				5.7
TSS	6		5.2	
T-Th230				
T-Tl				0.001
T-U		28		0.0005
TURB				0
T-Zn				0.01
V	0.05		0.05	
Zn	0.01		0.01	

— DRAFT —

This page intentionally left blank

SOURCE G

DOMESTIC AND LIVESTOCK WELLS MONITORED DURING FEBRUARY 1982 DEWEY PUMP TEST

(Letter from Gary Cummings, Silver King Mines, Inc., to Peter Martin, Tennessee Valley Authority, April 12, 1982)

This page intentionally left blank

D19 820414 007



Silver King Mines, Inc.

PO. Box 49
Edgemont, South Dakota 57735

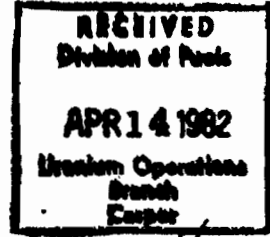

*EWTT
QAB*

April 12, 1982

Peter W. Martin
Technical Engineer
Edgemont Project
Tennessee Valley Authority
P. O. Box 2957
Casper, Wyoming 82602

RE: GWC; 223,82

Dear Pete:

Enclosed you will find the information relating to domestic and livestock wells that were monitored during the Dewey Pump Test.

If you have any questions, please call.

Very truly yours,

SILVER KING MINES, INC

[Handwritten Signature]
Gary W. Cummings
Resident Manager

GWC:dlg

Enclosure

cc: R. M. Caywood
D. H. Marks
R. H. Davidson
Mark Boggs

700 H Co (82)



40U Recompletion?

WELL NUMBERS	610				609		40		4002		40U Recompletion?				
	119	103	104	39	BPZ 20 FR	BPZ 20 LAK	0-7		40U	40L	102	13	41	48	BY-1 FR
DATE	FT	GPH	FT	FT	FT	FT	FT	GPH	PSI	GPH	FT	GPH	PSI	PSI	PSI
2-16-82	PUMP TEST STARTED														
2-17-82	-	-	-	26.89	Froze	4.88	4.54	-	-	-	-	-	-	-	-
2-18-82	10.73	.72	9.40	26.93	Froze	14.35	Froze at 4.54	-	-	-	-	-	-	-	-
2-19-82	-	-	-	26.83	3.91	20.18	4.61	-	-	-	-	-	-	-	-
2-19-82	-	-	-	-	4:00 PM 3.88	4:00 PM 22.44	-	-	-	-	-	-	-	-	-
2-20-81	10.69	.75	9.63	26.93	8:20 AM 3.96	8:20 AM 27.59	4.61	-	-	-	-	-	-	-	-
2-21-82	-	-	-	26.94	1:10 PM 3.95	1:10 PM 35.90	4.83	-	-	-	-	-	-	-	-
2-22-82	-	-	-	26.84	1:00 PM 3.89	1:00 PM 42.30	4.62	-	-	-	-	-	-	-	Stopped Flowing
2-23-82	-	-	-	-	3.91	10:30 AM 47.90	-	8:15 AM 1.48 GPM	-	10.80	-	-	-	-	-
2-23-82	-	-	-	-	-	-	-	2:30 PM .70 GPM	-	-	-	-	-	-	-
2-24-82	10.77	.70	9.62	Windmill Running	4.70	12:00 noon 54.32	4.78	Dribbles	-	10.90	-	-	-	-	-
2-25-82	-	-	-	28.43	5.00	10:40 AM 59.64	4.74	Drips	-	10.80	7.10	11.40	-	-	-
2-26-82	10.70	.72	9.53	-	4.73	12:18 PM 65.20	4.78	No Water	-	10.80	7.35	11.50	-	-	-
2-27-82	-	-	-	-	-	9:35 AM 69.35	-	-	-	-	-	-	-	-	-
2-27-82	-	-	-	-	-	3:20 PM 70.81	-	-	-	-	-	-	-	-	-
2-28-82	-	-	-	-	4.85	10:30 AM 71.00	4.67	-	-	-	-	-	-	-	-
3-1-82	10.62	.75	9.46	-	4.79	12:30 PM 67.91	4.56	-	-	10.90	5.74	11.40	-	-	-
3-1-82	-	-	-	-	4.88	1:08 PM 64.82	4.56	-	-	10.90	-	-	-	-	-
3-2-82	-	-	-	-	5.07	11:50 AM 62.10	4.59	.80	-	10.80	-	-	-	-	-
3-4-82	10.47	.72	9.52	-	5.29	12:10 PM 59.46	4.70	.80	-	10.80	6.37	11.20	-	-	-
3-5-82	-	-	-	-	5.49	2:25 PM 56.76	4.75	.92	-	-	-	-	-	13.54'	-
3-6-82	-	-	-	-	-	11:34 AM 54.89	-	-	-	-	-	-	-	11.05'	-
3-7-82	-	-	-	-	-	52.60	-	-	-	-	-	-	-	8.25'	-
3-8-82	10.70	.75	9.40	-	6.00	50.28	4.58	.80	-	10.80	6.63	-	-	5.54	-
3-10-82	10.42	-	-	-	6.98	46.37	4.58	.50	-	-	-	-	-	0.80	-
3-11-82	-	-	-	-	-	-	-	Dry	16 GPH 12 PSI	-	-	-	-	Flow 5 GPH 25 PSI	1.6 GPH 25 PSI
3-12-82	10.18	.77	9.41	-	6.49	42.98	4.61	-	-	9.80	6.86	10.80	-	Flow 8 GPH	-
3-15-82	-	-	-	-	6.73	38.42	4.85	-	14 PSI	-	-	-	-	Flow 15 GPH 25.8 PSI	-
3-17-82	-	-	-	-	7.15	36.05	4.99	-	14.45 PSI	-	-	-	-	5.45 PSI 25.5 PSI	-
3-19-82	10.50	.72	9.40	-	7.21	2:00 PM 33.48	4.91	-	15.20 PSI	10.6	6.66	-	-	6.75 25.0	-
3-22-82	-	-	-	-	7.65	Noon 30.58	5.49	-	14.75 PSI	-	-	-	-	8.00 25.0	-
3-24-82	-	-	-	-	7.81	1:00 PM 28.60	4.54	-	15.75 PSI	-	-	-	-	- 25.25	-
3-26-82	10.72	.70	9.42	-	7.95	11:45 26.73	4.47	-	17.25 PSI	8.8	9.50	10.5	9.80	25.0	-
3-30-82	-	-	-	-	7.92	23.38	-	-	18.40 PSI	-	-	-	-	25.0 PSI	-



WELL NUMBER	BPZ LA 22	BPZ FR 22	92	96	106	107	115	147	148	38	49	109	110	111	117
DATE	FT	FT	GPM	GPM	GPM	FT	GPM	FT	FT	GPM	GPM	FT	FT	FT	FT
2-16-82	PUMP TEST STARTED														
2-17-82	70.62	74.92	-	4.00	1.80	1.23	1.15	13.06	-	1.80	2.50	60.35	83.95	8.08	29.78
2-18-82	70.69	74.89	Well in use 1.50	4.00	1.75	1.25	1.15	13.06	-	1.75	Leaks 2.43	60.02	83.68	8.21	29.87
2-19-82	70.63	74.88	-	4.00	1.80	1.27	1.15	13.06	-	1.80	2.38	59.89	83.63	8.13	29.83
2-19-82															
2-20-82	70.74	74.96	1.55	4.00	1.75	1.26	1.15	13.05	-	1.80	2.42	Well in use 60.22	83.65	8.21	29.90
2-21-82	70.75	74.95	-	4.00	1.80	1.55	1.17	13.08	-	1.80	2.35	Well in use 60.60	83.86	8.26	29.94
2-22-82	70.71	74.91	-	9:00 AM 3.90	1.80	1.30	1.17	13.10	-	1.80	2.40	60.32	83.78	8.17	29.89
2-23-82	-	-	-	3.90	-	-	-	-	-	-	2.40	-	-	-	-
2-24-82	70.92	75.10	1.55	3.90	1.80	1.45	1.10	13.35	Water at Surface	1.80	2.40	60.35	83.96	8.33	29.95
2-25-82	70.92	75.09	-	3.90	1.80	1.42	1.10	13.68	Water at Surface	1.80	2.35	60.20	83.94	8.32	30.02
2-26-82	70.87	74.95	1.60	3.90	1.80	1.48	1.15	14.12	Water at Surface	1.80	2.35	Well in use 60.32	83.91	8.25	29.95
2-28-82	70.98	75.00	-	3.70	1.80	1.35	1.20	15.44	0.10'	-	2.35	60.57	84.21	8.29	30.00
3-01-82	70.75	74.87	1.60	3.95	1.80	1.24	1.20	16.32	.60	1.80	2.35	60.15	83.95	8.23	Pump on
3-02-82	70.82	74.85	-	3.95	1.80	1.23	-	17.09	.90	-	2.30	59.83	84.19	8.15	29.77
3-03-82	70.80	74.81	-	3.95	1.80	1.25	1.17	17.93	1.22	-	2.32	59.89	84.27	8.17	29.80
3-04-82	70.84	74.95	1.57	3.95	1.80	1.36	1.20	18.72	1.47	1.80	2.35	59.99	84.31	8.25	29.82
3-05-82	70.97	75.05	-	3.95	1.80	1.42	1.15	19.48	1.74	-	2.32	60.05	84.40	8.30	29.95
3-6-82	-	-	-	-	-	-	-	20.21	-	-	-	-	-	-	-
3-07-82	-	-	-	-	-	-	-	20.85	-	-	-	-	-	-	-
3-08-82	70.99	75.06	1.60	3.95	1.80	1.27	1.20	21.38	1.89	1.80	Leaks 2.35	60.00	84.49	8.31	30.35
3-10-82	70.91	74.98	-	3.75	1.80	1.23	No flow	22.35	1.73	-	-	60.00	84.51	8.16	29.90
3-11-82															
3-12-82	70.78	74.88	1.60	3.95	1.80	1.28	1.10	22.98	1.52	1.80	2.20	60.21	84.60	8.20	29.73
3-15-82	70.51	74.51	-	3.90	1.80	1.52	1.00	23.61	1.43	-	2.25	59.79	84.36	8.11	-
3-17-82	-	-	-	-	-	1.67	.85	23.86	1.41	-	Leaks 2.18	-	-	-	-
3-19-82	70.63	74.67	1.57	3.85	1.80	1.57	Well in use	24.02	1.22	1.80	2.20	59.75	84.40	8.15	-
3-22-82	-	-	-	-	-	1.80	1.10	24.05	1.15	-	2.18	-	-	-	-
3-24-82	-	-	-	-	-	1.23	1.12	24.04	.80	-	-	-	-	-	-
3-26-82	70.96	75.00	1.55	3.90	1.80	1.14	1.25	24.06	.76	1.70	2.25	60.02	84.77	8.40	29.92
3-30-82	-	-	-	-	-	-	-	24.02	.13	-	-	-	-	-	-

626

625

Dewey-Burdock GDP
June 2012

3.7-B-789

Appendix 3.7-B

This page intentionally left blank

SOURCE H
WYOMING WATER RIGHT 183561

This page intentionally left blank

FORM U.W. 5002
Rev. 7/83
FILING FEE SCHEDULE
ON REVERSE SIDE

36035081
50.00
6/12/07

STATE OF WYOMING
OFFICE OF THE STATE ENGINEER
HERSCHLER BLDG., 4-E CHEYENNE, WYOMING 82002
(307) 777-6183

1 of 4

APPLICATION FOR PERMIT TO APPROPRIATE GROUND WATER

APPLICATION FOR WELLS AND SPRINGS

Note: Only springs flowing 25 gallons per minute or less, where the proposed use is domestic and /or stock watering, will be considered as ground water appropriations.

FOR OFFICE USE ONLY

Temporary Filing No. U.W. 403-211

PERMIT NO. U.W. 183561
WATER DIVISION NO. 2 DISTRICT 1
U.W. DISTRICT Newcastle

NOTE: Do not fold this form. Use typewriter or print neatly with black ink.
ALL ITEMS MUST BE COMPLETED BEFORE APPLICATION IS ACCEPTABLE

NAME AND NUMBER OF WELL or SPRING Putnam 21

1. Name of applicant(s) Putnam & Putnam, LLP Phone: (605)662-7448
2. Address of applicant(s) 778 Cedar St. Dewey SD 57735
(MAILING ADDRESS) (CITY) (STATE) (ZIP)
3. Name & address of agent to receive correspondence and notices John A. Putnam
778 Cedar St. Dewey SD 57735 Phone: (605)662-7448
(MAILING ADDRESS) (CITY) (STATE) (ZIP)

4. Use to which the water will be applied:

- Domestic: Use of water in 3 single family dwellings or less, noncommercial watering of lawns and gardens totaling one acre or less. Number of houses served? _____
- Stock Watering: Normal livestock use at four tanks or less within one mile of well or spring. Stockwatering pipelines and commercial feedlots are a miscellaneous use. Number of stock tanks? 1 *Per call 7/19/07*
- Irrigation: Watering of commercially grown crops (large-scale lawn watering of golf courses, cemeteries, recreation areas, etc., is miscellaneous use).
- Municipal: Use of water in incorporated Towns and Cities. Note 1: use of water in unincorporated towns, subdivisions, improvement districts, mobile home parks, etc. is classified as miscellaneous use. Note 2: a permit may be required by the Wyoming Department of Environmental Quality (WDEQ) if the well will be classified as a public water supply under the WDEQ's rules and regulations.
- Industrial: Long term use of water for the manufacture of a product or production of oil/gas or other minerals (oil field water flood operations, power plant water supply, etc.). (Describe in REMARKS)
- Miscellaneous: *Per call 7/19/07* Any use of water not defined under previous definitions such as stock water pipelines, subdivisions, mine dewatering, mineral/oil exploration drilling, potable supplies in office, etc Describe in Remarks. Note: a permit may be required by the WDEQ if the well will be classified as a public water supply under the WDEQ's rules and regulations.
- Coalbed Methane: Water produced in the production of coal bed methane gas. Note: wells used in the production coal bed methane will require a permit from the Wyoming Oil and Gas Conservation Commission.
- Monitor, Observation: Note: a WDEQ permit may be required Test Well: (Describe in REMARKS)

5. Location of the well or spring: (NOTE: Quarter-quarter (40 acre subdivision) MUST be shown. EXAMPLE: SE 1/4 NW 1/4 of Sec. 12, Township 14 North, Range 08 West.)
Niobrara County, SW 1/4 SW 1/4 of Sec. 28, T. 41 N., R. 60 W. of the 6th P.M. (W.R.M.), Wyoming. If located in a platted subdivision, also provide Lot/Tract _____ of the Subdivision (or Ad'n) of _____ Resurvey Location: Tract _____, (or Lot) _____

6. Estimated depth of the well or spring is 600 feet. Estimated production interval is Unknown ft. to _____ ft.

7. (a) MAXIMUM instantaneous flow of water to be developed and beneficially used: 10 gallons per minute. NOTE: if for domestic and / or stock use, this application will be processed for a maximum of 25 gallons per minute. For a spring, after approval of this application, some type of artificial diversion or improvement must be constructed to qualify for a water right.

(b) MAXIMUM volumetric quantity of water to be developed and beneficially used per calendar year: 10 5 *Per call 7/19/07*
Circle appropriate units: (Gallons) (Acres Feet) A four person family utilizes approximately one (1) acre-foot of water per year or 325,000 gallons.

8. Mark the point(s) or area(s) of use in the tabulation box below.

TABULATION BOX

TWP	RNG	SEC	NE 1/4				NW 1/4				SW 1/4				SE 1/4				TOTAL
			NE 1/4	NW 1/4	SW 1/4	SE 1/4	NE 1/4	NW 1/4	SW 1/4	SE 1/4	NE 1/4	NW 1/4	SW 1/4	SE 1/4	NE 1/4	NW 1/4	SW 1/4	SE 1/4	
41	60	28											X						1 Stock Tank

Permit No. U.W. 183561 SEE REVERSE SIDE Book No. 1329 Page No. 61



FORM U.W.6
Rev. 1.07

STATE OF WYOMING
OFFICE OF THE STATE ENGINEER
HERSCHLER BLDG., 4-E
CHEYENNE, WYOMING 82002

(307) 777-6163

STATEMENT OF COMPLETION AND DESCRIPTION OF WELL OR SPRING

NOTE: Do not fold this form. Use typewriter or print neatly with black pen.

PERMIT NO. U.W. 183561 NAME OF WELL/SPRING Putnam 21

1. NAME OF OWNER PUTNAM & PUTNAM, LLP

2. ADDRESS 778 CEDAR ST

Please check if address has changed from that shown on permit

City DEWEY State SD Zip Code 57735 Phone No 605-662-7448

3. USE OF WATER Domestic Stock Watering Irrigation Municipal Industrial Miscellaneous
 Monitor or Test Coal Bed Methane Explain proposed use (Example: One single family dwelling)

1 stock tank

4. LOCATION OF WELL/SPRING SW 1/4 SW 1/4 of Section 28 T. 41 N., R. 60 W., of the 6th P.M. (or W.R.M.)
Subdivision Name _____ Lot _____ Block _____

Resurvey Location Tract _____ or Lot _____ Datum NAD27 NAD83

Geographic Coordinates: Latitude _____ N Longitude _____ W (degrees, minutes, seconds)

UTM: Zone 13 Northing 7816400 Easting 574367 (meters) per

State Plane Coordinates: Zone _____ Northing _____ Easting _____ (feet) 1012367

Land surface elevation (ft. above mean sea level) _____ Datum NAVD29 NAVD88

Source GPS Map Survey Unknown Other Altimeter (for elevation only)

5. TYPE OF CONSTRUCTION Drilled Dug Driven Other

Describe _____

6. CONSTRUCTION Total depth of well/spring 6.39 ft.

Depth of static water level 0 ft. (below land surface) Casing height 2 ft. above ground

a. Diameter of borehole (bit size) 5 inches

b. Casing schedule New Used Joint type Threaded Glued Welded

_____ diameter from _____ ft. to _____ ft. Material _____ Gage _____

_____ diameter from _____ ft. to _____ ft. Material _____ Gage _____

c. Cemented/grouted interval, from _____ ft. to _____ ft.

Amount of cement/grout used _____ type _____

(example: 10 sacks; (example: bentonite pellets)

d. Type of completion Customized perforations Open hole Factory screen

Type of perforator used _____

Size of perforations _____ inches by _____ inches.

Number of perforations and depths where perforated

_____ perforations from _____ ft. to _____ ft.

_____ perforations from _____ ft. to _____ ft.

Open hole from _____ ft. to _____ ft.

Well screen details

Diameter _____ slot size _____ set from _____ ft. to _____ ft.

Diameter _____ slot size _____ set from _____ ft. to _____ ft.

e. Well development method _____ How long was well developed? _____

f. Was a filter/gravel pack installed? Yes No Size of sand/gravel _____

Filter/gravel pack installed from _____ ft. to _____ ft.

g. Was surface casing used? Yes No Was it cemented in place? Yes No

Surface casing installed from _____ ft. to _____ ft.

7. NAME AND ADDRESS OF DRILLING COMPANY UW KNOWL

8. DATE OF COMPLETION OF WELL (including pump installation) OR SPRING (first used) 1936

9. PUMP INFORMATION Manufacturer None Type _____

Source of power _____ Horsepower _____ Depth of pump setting or intake _____ ft.

Amount of water being pumped _____ gal./min.* (For springs or flowing wells, see item 10)

Total volumetric quantity used per calendar year: 5 AF/yr per U.W. 5

*If these amounts exceed permitted amount an enlargement is required.

10. FLOWING WELL OR SPRING (Owner is responsible for control of flowing well)

If artesian flow or spring, yield is 5 gal./min. *Surface pressure is _____ lb./sq.inch, or _____ feet of water.

The flow is controlled by Valve Cap Plug

Does well leak around casing? Yes No

Permit No. U.W. 183561 Book No. 1329 Page No. 61

SEE REVERSE SIDE



11. IF SPRING, HOW WAS IT CONSTRUCTED? (Some method of artificial diversion, i.e., spring box, cribbing, etc., is necessary to qualify for a water right)

12. PUMP TEST Was a pump test conducted? Yes No

If so, by whom

Yield gal./min. with ft. drawdown after hours

Yield gal./min. with ft. drawdown after hours

13. LOG OF WELL Total depth drilled 639 ft.

Depth of completed well ft. Diameter of well inches

Depth to first water bearing formation ft.

Depth to principal water bearing formation Top ft. to Bottom ft.

DRILL CUTTINGS DESCRIPTION

Table with 5 columns: From Feet Surface, To Feet, Rock Type or Description, Formation, Water Bearing? (Yes or no). Contains handwritten text 'Not Available'.

14. DOES A GEOPHYSICAL LOG ACCOMPANY THIS FORM? Yes X No

15. QUALITY OF WATER INFORMATION

Does a chemical and/or bacteriological water quality analysis accompany this form? Yes No

It is recommended that chemical and bacteriologic water quality analyses be performed and that the report(s) be filed with the records of this well (contact Department of Agriculture, Analytical Lab Services, Laramie, 742-2984).

If not, do you consider the water as Good Acceptable Poor Unusable

REMARKS

Under penalties of perjury, I declare that I have examined this form and to the best of my knowledge and belief it is true, correct, and complete.

Signature of Owner or Authorized Agent

Date 10.15.07

FOR STATE ENGINEER'S USE ONLY

Permit No. U.W. 183361

Date of Receipt OCT 18 2007

Date of Approval 10 29 2007

Date of Priority June 12 2007

Signature of State Engineer

SOURCE I

ADDITIONAL WATER WELLS IN EDGEMONT PROJECT AREA

(Silver King Mines, Inc., Interoffice Correspondence, Keith Andersen to R.M. Caywood, August 3, 1979)

This page intentionally left blank



POWERTECH (USA) INC.

INTEROFFICE CORRESPONDENCE

Company Silver King Mines, Inc. Date August 3, 1979

To: R. M. Caywood

From: Keith E. Andersen Subject: Quarterly Burdock Area Water Levels

Attached are quarterly measurements of Burdock Area water well flow rates and water levels. Wells numbered 135 - 143 are new wells or wells added to our monitoring program by request. Wells numbered 200 - 216 are probable Sundance wells located east of the Burdock Area.

In an effort to obtain all possible information, several measurements of questionable accuracy were made as noted below.

<u>Well No.</u>	<u>Problem</u>
2	Leaking around casing
4	Leaking around casing
75	Measuring point changes
13	Pipeline use affects flow
33	Measuring point changes
35	Measured inside cylinder drop pipe
36	Leaking around pipeline fittings
37	Measured inside cylinder drop pipe
40	Two wells at different elevations piped together
41	Pump had been operating
42	Leaking around pipeline fittings
52	Measuring point changed
53	Measured through cylinder drop pipe
56	Casing broken out
98	Casing leaking
113	Measured inside cylinder drop pipe
114	Measured inside cylinder drop pipe

Water quality data on these wells is not yet complete.

Keith E. Andersen
Keith E. Andersen, Chief Engineer



Additional Water Wells In Edgemont Project Area

<u>Well No.</u>	<u>Location</u>
135	T 8 S, R 2 E, Sec. 1 bd
136	T 8 S, R 2 E, Sec. 5 bb
137	T 7 S, R 2 E, Sec. 17 bd
138	T 6 S, R 1 E, Sec. 18 a
139	T 41 N, R 60 W, Sec. 18 dd
140	T 9 S, R 3 E, Sec. 19 bc
141	T 10 S, R 3 E, Sec. 20 aa
142	T 7 S, R 2 E, Sec. 35 bd
143	T 8 S, R 1 E, Sec. 30 dc
200	T 7 S, R 2 E, Sec. 13 ca
201	T 7 S, R 2 E, Sec. 13 ca
202	T 7 S, R 2 E, Sec. 13 ca
203	T 7 S, R 2 E, Sec. 12 cd
204	T 7 S, R 2 E, Sec. 12 cb
205	T 7 S, R 2 E, Sec. 12 ac
206	T 7 S, R 2 E, Sec. 12 ac
207	T 7 S, R 2 E, Sec. 12 aa
208	T 7 S, R 2 E, Sec. 2 bc
209	T 7 S, R 2 E, Sec. 3 da
210	T 7 S, R 2 E, Sec. 2 bd
211	T 7 S, R 2 E, Sec. 12 ba
212	T 8 S, R 3 E, Sec. 8 db
213	T 7 S, R 3 E, Sec. 20 dc
214	T 7 S, R 3 E, Sec. 18 cd
215	T 6 S, R 2 E, Sec. 27 dd
216	T 6 S, R 2 E, Sec. 22 aa
144	T 9 S, R 3 E, Sec. 21
145	T 8 S, R 2 E, Sec 3 dc
146	T 9 S, R 2 E, sec 21 bc

Additional Water Wells In Edgemont Project Area

<u>No.</u>	<u>Owner</u>	<u>Use</u>	<u>Depth</u>	<u>Probable Aquifer</u>	<u>Remarks</u>
135	Mike Ringer	D,S	360	Lakota	Drilled 1977 - Submersible Pump
136	Ed Dodson	D,S		Spring	Source Uncertain
137	USFS	S			Windmill
138	John Carlson	D	100	Fall River	Drilled 1977, flows, Jet Pump
139	Gerald Darrow	S	620	Lakota	Drilled 1978, flows 20 gpm
140	Ken Barker	D,S			
141	Howard Henderson	S		Spring	Source Uncertain
142	Jack Standen	D,S	280	Fall River	Submersible Pump
143	Jeff Schultz	D,S	1,640	Fall River	Drilled 1962, Submersible Pump @ 440
200	George Hey	D,S	108	Sundance	Water Level 52.7', Submersible Pump
201	George Hey	S	110	Sundance	Pump Jack
202	George Hey	S	200	Sundance	Water Level 16.7'
203	Donald Spencer	D,S	200	Sundance	Submersible Pump at 160
204	Donald Spencer	U	170	Sundance	
205	Mason Miller	U	108	Sundance	Water Level 24.5
206	Mason Miller	D,S	200	Sundance	Water Level 18.4, Jet Pump
207	Mason Miller	D,S			Submersible Pump, Pipeline
208	Mason Miller	S	179	Sundance	Pump Jack
209	Donald Spencer	U	247	Sundance	Water Level 145.2
210	George Hey	S	125	Sundance	Pump Jack
211	Donald Spencer	S	161	Sundance	Pump Jack - Water Level 8.14
212	Carl Reutter	S	2,204		Flows 1.5 gpm, old oil test
213	George Hey	S	100	Sundance	Submersible Pump, Water Level 34.1
214	George Hey	S	270	Sundance	Water Level 391
215	Claude Smith	S	900		Water Level 60.7, Submersible Pump, Pipeline
216	Claude Smith	U			Water Level 217.9
144		S.O			Water Level 368.4'

This page intentionally left blank

SOURCE J

FOREST SERVICE WELLS AND SPRINGS

(Letter from Keith Andersen, Silver King Mines, Inc., to John Hatch, South Dakota Water Rights Commission, January 12, 1979)

This page intentionally left blank



FOREST SERVICE WELLS AND SPRINGS

This list of wells and springs located on U. S. Forest Service land was obtained from the Forest Service office in Newcastle, Wyo. These wells and springs will be visited and an attempt made to determine the aquifer from which they produce. The water on Forest Service land is used by ranches for stock water during the summer months and to supply water for wild life.

Name	Location	
Bennett Canyon Well	T7S, R2E, SW $\frac{1}{4}$, Sec. 7	#114
Driftwood Canyon Well	NW $\frac{1}{4}$, Sec. 16	no match > 2 km
Heck Well	NW $\frac{1}{4}$, Sec. 17	#137 > 2 km
Spencer Well	NE $\frac{1}{4}$, Sec. 7	no match
Bennett # 2 Well	SW $\frac{1}{4}$, Sec. 6	#113
Hey Well	T7S, R3E, SW $\frac{1}{4}$, Sec. 18	> 2 km
Roderick Spring	T7S, R2E, SE $\frac{1}{4}$, Sec. 18	
North Roderick Spring	NE $\frac{1}{4}$, Sec. 17	
North Long Mountain Spring	T7S, R3E, NW $\frac{1}{4}$, Sec. 32	
South Long Mountain Spring	NW $\frac{1}{4}$, Sec. 32	
Dewey Well	T6S, R1E, SW $\frac{1}{4}$, Sec. 5	#120 > 2 km
Cook Well	NW $\frac{1}{4}$, Sec. 9	no match > 2 km
Pass Creek Well	NE $\frac{1}{4}$, Sec. 22	#632 > 2 km
Lower Turkey Spring	T5S, R1E, SW $\frac{1}{4}$, Sec. 32	
Turkey Spring	NE $\frac{1}{4}$, Sec. 32	
Tailend Reservoir Spring	Sec. 15	
Bowl Spring	T5S, R1E, NE $\frac{1}{4}$, Sec. 29	
Bosley Spring	SE $\frac{1}{4}$, Sec. 17	
Barrel Spring	NW $\frac{1}{4}$, Sec. 7	
Sheepwagon Spring	T4S, R1E, SW $\frac{1}{4}$, Sec. 32	
Lower Dugout Spring	NW $\frac{1}{4}$, Sec. 29	
Dugout Spring	NE $\frac{1}{4}$, Sec. 19	
North Spring	Sec. 6	
South Spring	Sec. 6	
Carr Spring	T42N, R60W, SE $\frac{1}{4}$, Sec. 4	
Mix Spring	T43N, R60W, NW $\frac{1}{4}$, Sec. 28	
Pipeline Spring	Sec. 21	
Pollard Spring	NE $\frac{1}{4}$, Sec. 9	

This page intentionally left blank

SOURCE K

HYDROGEOLOGIC INVESTIGATIONS AT PROPOSED URANIUM MINE NEAR DEWEY, SOUTH DAKOTA

(Report No. WR28-2-520-128, J. Mark Boggs, Tennessee Valley Authority, October 1983)

This page intentionally left blank

WR28-2-520-128

**HYDROGEOLOGIC INVESTIGATIONS
AT PROPOSED URANIUM MINE
NEAR DEWEY, SOUTH DAKOTA**

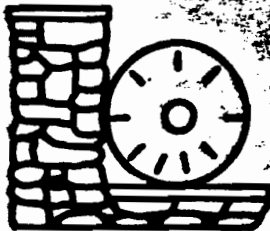
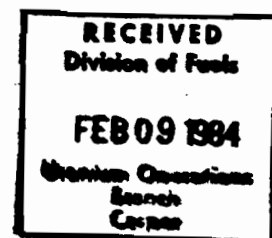

**TENNESSEE VALLEY AUTHORITY
OFFICE OF NATURAL RESOURCES
DIVISION OF AIR AND WATER RESOURCES
WATER SYSTEMS DEVELOPMENT BRANCH
NORRIS, TENNESSEE**



Tennessee Valley Authority
Office of Natural Resources
Division of Air and Water Resources
Water Systems Development Branch

HYDROGEOLOGIC INVESTIGATIONS AT
PROPOSED URANIUM MINE NEAR
DEWEY, SOUTH DAKOTA

Report No. WR28-2-520-128

Prepared by
J. Mark Boggs

Norris, Tennessee
October 1983

ABSTRACT

The Lakota and Fall River Formations represent aquifers of major importance in the Southern Black Hills Region as well as host rock for uranium ore. An 11-day constant discharge test involving 13 observation wells and numerous private wells was conducted in the Lakota aquifer at TVA's proposed uranium mine near Dewey, South Dakota. The pumping phase of the test was followed by several months of water-level recovery measurements. Results indicate that the test site is located in an area where the Lakota is exceptionally permeable having a transmissivity of 4,400 gpd/ft and a storativity of about 1×10^{-4} . Outside of this locality the Lakota transmissivity decreases substantially due to aquifer thinning and a change to finer-grained sedimentary facies. The drawdown response in the Fall River aquifer was substantially less than that observed during a similar test conducted at TVA's proposed Burdock mine, indicating that the Fuson shale unit lying between the two aquifers is a more effective aquitard in the Dewey area. It is further concluded that the nearby Dewey fault acts as a barrier to horizontal ground-water movement in the Lakota and Fall River aquifers.

CONTENTS

	<u>Page</u>
Abstract	i
Introduction	1
Hydrogeologic Environment	1
Lakota Aquifer Test	4
Design	4
Procedures	6
Analysis	8
Interpretation	10
Computer Simulations	13
Conclusions	20
Recommendations for Future Ground-Water Impact Assessment . . .	22
References	24
Appendix A Semilogarithmic Time-Drawdown Graphs	25
Appendix B Logarithmic Time-Drawdown Graphs	35
Appendix C Semilogarithmic Time-Residual Drawdown Graphs. . .	45

FIGURES

1. Site Location and Potentiometric Surface Map	2
2. Well Location Map	5
3. Distance-Drawdown Graph	11
4. Ground-Water Model Grid	14
5. Comparison of Observed and Computed Drawdown, Case I. . .	16
6. Transmissivity Distribution, Case II	17
7. Comparison of Observed and Computed Drawdown, Case II . .	19

TABLES

1. Well Construction Data	7
2. Computed Lakota Aquifer Properties	9

INTRODUCTION

The following report describes a hydrogeologic test conducted February 1982 at TVA's proposed uranium mine shaft site near Dewey, South Dakota (Figure 1). The Dewey test is one of a series of tests TVA has conducted in aquifer units of the Inyan Kara Group in the southwestern Black Hills area. The purpose of these tests is to obtain sufficient quantitative information about local hydrogeologic conditions to enable prediction of mine depressurization requirements and impacts to local ground-water users.

HYDROGEOLOGIC ENVIRONMENT

The principal aquifers in the region are the alluvial deposits associated with the Cheyenne River and its major tributaries, the Fall River formation, the Lakota formation, the Sundance formation, and the Pahasapa (or Madison) formation. Except for the alluvium, these aquifers crop out peripherally to the Black Hills where they receive recharge from precipitation. Ground-water movement is in the direction of dip, radially from the central Black Hills. In most instances, ground water in these aquifers is under artesian conditions away from the outcrop area, and water flows at ground surface from numerous wells in the area.

The Fall River and Lakota formations which form the Inyan Kara Group are the most widely used aquifers in the region. The alluvium is used locally as a source of domestic and stock water. The Sundance formation is used near its outcrop area in central and northwestern Fall River County. The Pahasapa (Madison) formation is locally accessible only by very deep wells and is the source for five wells in the city of Edgemont.

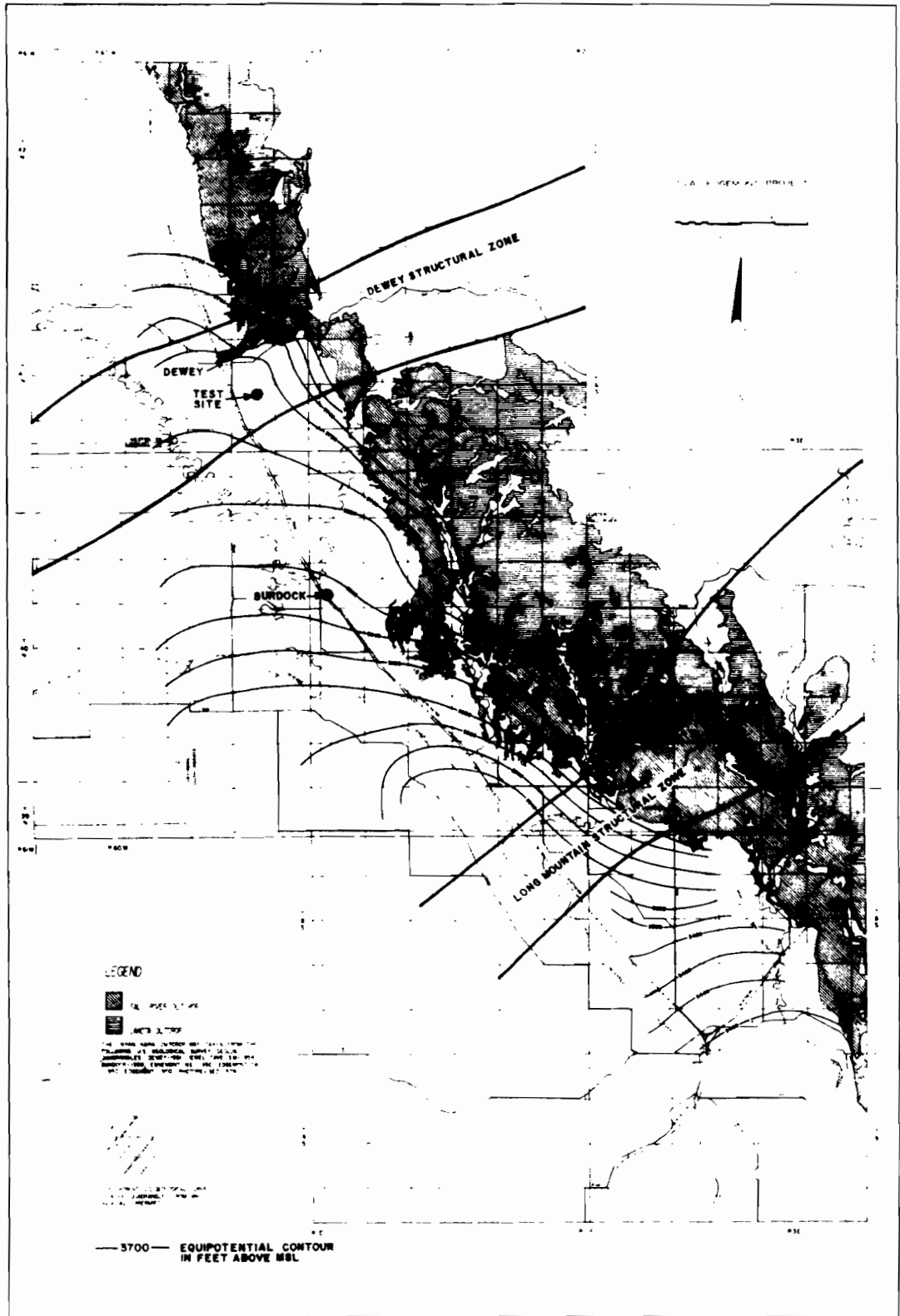

Figure 1: Site Location and Potentiometric Surface Map

IR28-28-2-520-128

The Fall River and Lakota aquifers are of primary concern because of the potential impact of mine dewatering on the numerous wells developed in these aquifers in the vicinity of the mine. At the proposed mine site, the Fall River consists of approximately 180 feet of interbedded fine-grained sandstone, siltstone and carbonaceous shale. The Fall River aquifer is overlain by approximately 400 feet of the Mowry and Skull Creek shales unit, which act as confining beds. Five domestic and stock-watering wells are known to be developed in the Fall River formation within a four-mile radius of the mine site.

The Fall River formation is underlain by Fuson member of the Lakota formation consisting primarily of siltstone and shale with occasional fine-grained sandstone lenses. Thickness of the Fuson is on the order of 100 feet in the site vicinity. The Fuson acts as a leaky aquitard between the Fall River and Lakota aquifers.

The Chilson member of the Lakota formation is the source for some 30 wells within a four-mile radius of the mine site. It also represents the primary uranium-bearing unit targeted for mining. The Chilson (also referred to as the "Lakota aquifer" in this report) consists of about 120 feet of consolidated to semi-consolidated, fine-to-coarse grained sandstone with interbedded siltstone and shale. It is underlain by the Morrison formation consisting of interbedded shale and fine-grained sandstone. Regionally, the Morrison is not considered an aquifer. Under conditions of ground-water withdrawal from the Chilson, the Morrison is expected to act as an aquitard.

Recharge to the Fall River and Lakota aquifers is believed to occur at their outcrop areas. Gott, et al. (1974), suggest on the basis of geochemical data that recharge to these aquifers may also be derived from the upward movement of ground water along solution collapses and breccia

pipes from the deeper Minnelusa and Pahasapa aquifers. The solution collapse and breccia pipe features lie within the Dewey and Long Mountain structural zones (Figure 1).

Inasmuch as the proposed mine site lies only about one mile south of the Dewey fault trace, one of the primary objectives of the test was to determine the hydrologic significance of the fault and its affect on the propagation of drawdown in the vicinity of the mine during depressurization. Vertical displacement on the major fault generally increases toward the southwest, and is on the order of 200 feet at the point where the fault trace crosses the South Dakota-Wyoming border. Thus, it appears that the Fall River and Lakota aquifers are completely offset by the fault in the site vicinity.

LAKOTA AQUIFER TEST

Design

The shaft site for the Dewey mining area had not been selected at the time the aquifer testing designs were made. The test site was, therefore, located in the general vicinity of the proposed mine site within close proximity to the Dewey fault. The test well was completed to a depth of 804 feet and was screened within the Chilson member of the Lakota Formation. A network of eleven observation wells were constructed along two perpendicular lines intersecting at the pumped well for the purpose investigating hydrologic boundary conditions. One line of wells was oriented normal to the Dewey fault trace, and the other was approximately normal to the aquifer outcrop belt to the east (see Figure 2). Seven of these wells were developed in the Chilson member, three in the Fall River formation,

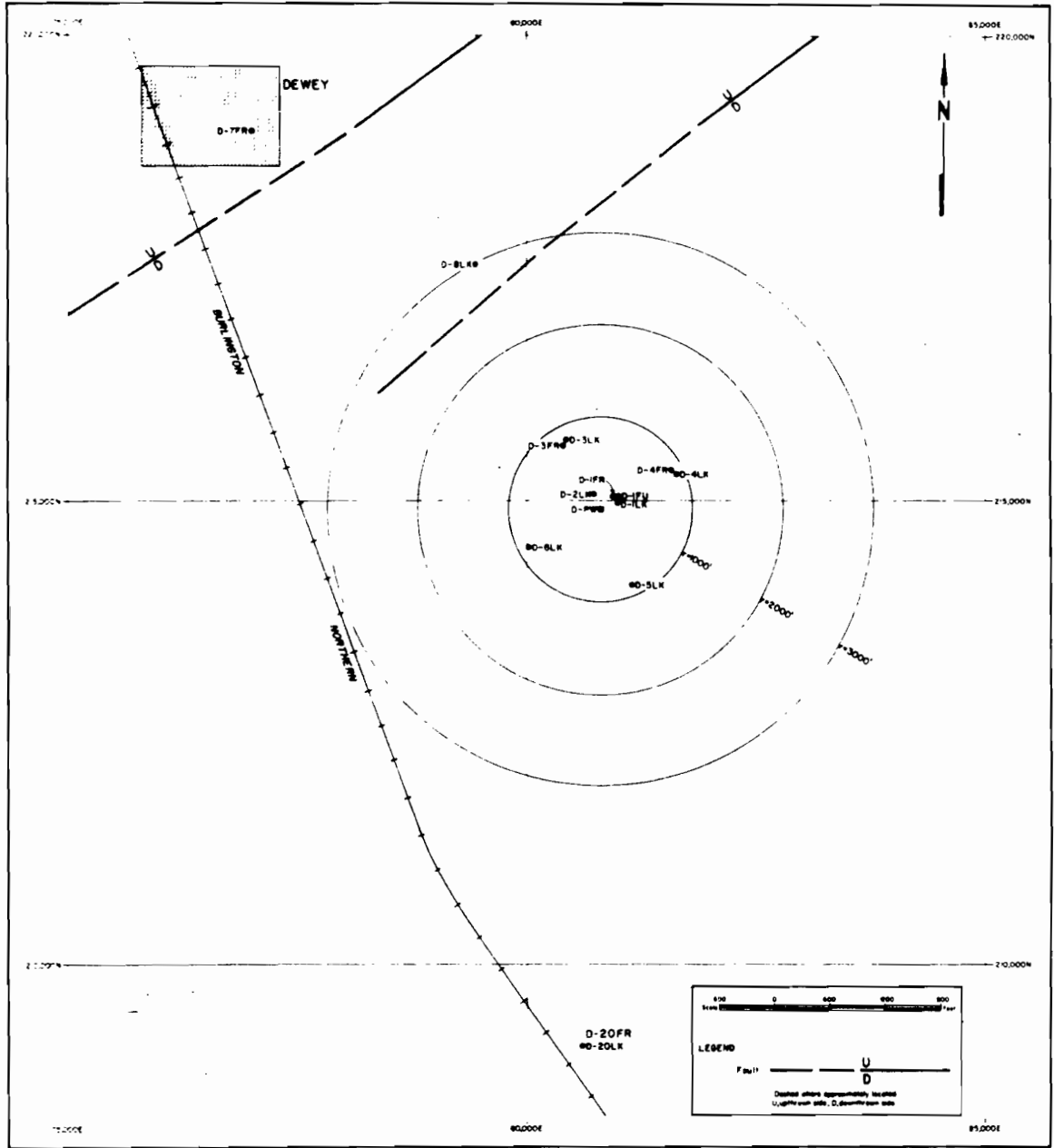

Figure 2: Well Location Map

RZB - 2 - 520 - 128 . 2

and one in the Fuson. Preexisting observation wells BPZ-20LAK and BPZ-20FR (hereafter referred to as D-20LK and D-20FR, respectively) located about one mile south of the test well were also monitored during the test. Construction details for these wells are given in Table 1. In addition, periodic measurements of water level (or well flowrate) were made during the test at all private wells within the test site vicinity.

Based upon preliminary drilling results in the Dewey test site area and experience from the Burdock aquifer tests, it was expected that the Fall River and Lakota aquifers in the Dewey area would respond essentially as a single aquifer system. As a result less emphasis was placed on measurement of the Fuson aquitard properties.

Procedures

A constant-discharge aquifer test was initiated at 1000 hours on February 16, 1982. Discharge from the well was pumped into an arroyo which ultimately drained into a stock pond located about one mile west of the test site. There was no possibility of recirculation of well discharge water during the test due to the 400+ feet thickness of shale between ground surface and the top of the Fall River aquifer. The well pumping rate was monitored with an in-line flow meter and with an orifice plate and manometer device at the end of the discharge line. The pumping rate varied little during the test ranging from 493 to 503 gpm and averaging 495 gpm. The pumping phase of the test lasted 11 days and was followed by approximately 10 months of recovery measurements. Water level measurements in all wells were made with electric probes. Flow rates associated with offsite private wells were checked with a bucket and stop watch.

TABLE 1. Well Construction Data

<u>Well No.</u>	<u>Depth (feet)</u>	<u>Casing Diameter (inches)</u>	<u>Depth Interval of Open Borehole or Well Screen (feet)</u>	<u>Distance From Pumped Well (feet)</u>
D-PW	804	10	695-725, 755-800	--
D-1LK	800	4	712-800	189
D-1FU	620	4	609-620	229
D-1FR	580	4	504-580	186
D-2LK	800	4	692-800	191
D-3LK	800	4	715-800	851
D-3FR	590	4	505-590	810
D-4LK	780	4	714-780	905
D-4FR	580	4	503-580	879
D-5LK	835	4	735-835	872
D-6LK	810	4	715-810	890
D-7FR	120	4	119-120	5610
D-8LK	750	4	650-750	2785
D-20LK	860	4	798-860	5700
D-20FR	672	1	671-672	5700

Analysis

Semilogarithmic graphs of drawdown (s) versus time (t) for the pumped well and observation wells are given in Appendix A. The drawdown trends in wells D-PW, D-1LK and D-2LK are essentially the same, i.e., there is a period of roughly linear drawdown during the first 1000 minutes of the test, followed by a gradual increase in the rate of drawdown during the remainder of the test. The remaining Lakota wells exhibit s - t curves which have a continuous increase in slope throughout the test without stabilizing to a linear drawdown trend. A slight increase in hydrostatic water level was observed during the early period of the test in the Fall River and Fuson wells. This seemingly paradoxical behavior, known as the Noordbergum effect, is due to a transfer of stress from the pumped aquifer to the adjacent aquitards and aquifers (Gambolati, 1974). Drawdowns observed in the Fall River and Fuson wells were much less than those recorded during a similar test conducted near Burdock (Boggs and Jenkins, 1980). The Jacob straight-line method (Walton, 1970) was applied to the semilog graphs for the Lakota wells to obtain the values of transmissivity (T) and storativity (S) presented in Table 2. In the case of the closer observation wells, two straight-line data fits were possible: one using the early data and another using the late data. Only the late data for the more distant observation wells were analyzed by this method.

Logarithmic s - t graphs for all test wells are given in Appendix B. Theis curve-matching techniques (Walton, 1970) were applied to the Lakota aquifer curves to obtain the T and S estimates presented in Table 2. Due to the somewhat unusual shape of the s - t response curves, the only curve-match solutions possible were those using the early data.

TABLE 2. Computed Lakota Aquifer Properties

Well	r (ft)	Jacob Method					Theis Method	
		Drawdown			Recovery		T_e	S_e
		T_e	S_e	T_1	T_e	T_1		
D-PW	0.67	4400	--	890	4890	680	--	--
D-1LK	189	5280	3.E-05	890	4890	650	5210	3.E-05
D-2LK	191	4400	3.E-04	910	4710	650	4090	2.E-04
D-3LK	851	--	--	920	--	670	6900	7.E-05
D-4LK	905	--	--	900	--	680	4090	8.E-05
D-5LK	872	--	--	900	--	670	4410	7.E-05
D-6LK	890	--	--	900	--	650	6030	8.E-05
D-8LK	2785	--	--	940	--	680	3180	5.E-05
D-20LK	5700	--	--	--	--	680	1400	3.E-05

Note: Transmissivity (T_e , T_1) in units of gpd/ft.

A semilog plot of the final drawdown in each Lakota well versus its radial distance from the pumped well is shown in Figure 3. The Jacob straight-line method was applied to this plot to obtain T and S values of 4400 gpd/ft and 10^{-6} , respectively, for the Lakota aquifer. The storativity value computed by this method is considered highly unreliable since it is two orders of magnitude lower than expected.

Water level recovery data for all wells are presented in Appendix C. Data are plotted as semilog graphs of residual drawdown versus t/t' (ratio of time since pumping started to time since pumping stopped). The Lakota graphs were analyzed using the Jacob method. Again, two straight-line fits are possible for the closer Lakota wells. Both are given in Table 2.

Fuson aquitard properties were estimated from the D-1 well group data using the ratio method (Neuman and Witherspoon, 1973). The vertical hydraulic conductivity of the aquitard (K'_v) is computed to be approximately 2×10^{-4} ft/d based on the average of several computed K'_v during the interval between 1800 and 5000 minutes. For purposes of the analysis, the specific storativity (S'_s) of the aquitard was assumed to be approximately equal to that computed for the Lakota aquifer (about 7×10^{-7} ft⁻¹).

Interpretation

The T estimates obtained from all methods using the early drawdown and recovery data are in reasonably good agreement. Values range from 3180 to 6900 gpd/ft and average approximately 4800 gpd/ft. The T of 4400 gpd/ft derived from the distance drawdown analysis is also consistent with the early T estimates. These values are believed to represent the transmissivity of the Lakota aquifer within the immediate vicinity of the test

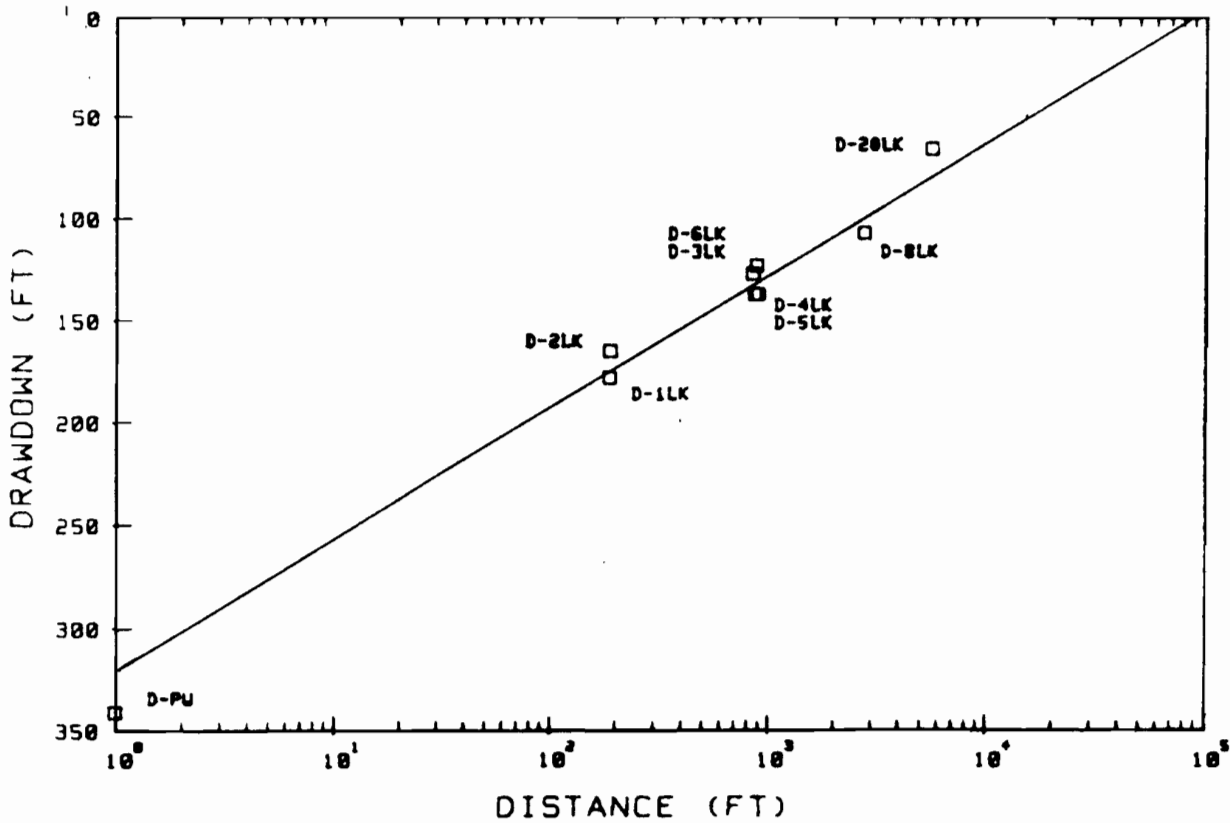

FIGURE 3. DISTANCE-DRAWDOWN GRAPH

WR28-2-520-128.3

Dewey-Burdock GDP
June 2012

3.7-B-823

Appendix 3.7-B

site, and are consistent with the physical characteristics of the aquifer materials within this area. The T values computed from the late drawdown data, although consistent from well to well, are not reliable since the rate of drawdown during the later stage of the test never stabilized to the linear or ideal Theis-curve trend. The late recovery data provide the best estimates of the regional or long-term transmissivity of the Lakota aquifer in the Dewey region because of the long duration of this phase of the test.

In general, drawdown response in the pumped well and closer observation wells is characterized by a period of approximately linear drawdown during the first 1000 minutes of the test, followed by a steadily increasing rate of drawdown until the end of the test. The recovery data reflects the same sort of trend. The late response may be interpreted as either the effect of barrier boundary conditions or a decrease in transmissivity with distance from the test site or both.

Most of the available hydrogeologic information indicates that the Dewey fault acts as a barrier to horizontal ground-water movement in the Inyan Kara aquifers. Vertical displacement along the Dewey fault is on the order of 200 feet in the test site vicinity causing the complete separation of the Lakota aquifer on either side of the fault. Despite the geochemical evidence of Gott, et al. (1974), that the fault may act as conduit for upward circulation of ground water from deeper aquifers to the Inyan Kara Group, a recharge condition is not reflected in the potentiometric surface configuration in the fault zone (Figure 1) or in the test results. A reduction in the rate of drawdown would be expected in the s-t graphs for observation wells closest to the fault if significant recharge occurred in the fault zone. Instead the opposite response is observed in the test data. The s-t curve for well D-8LK (the closest observation well to the fault)

exhibits the steepest slope during the late stage of the test, supporting the idea that the fault is a hydrogeologic barrier. Upward recharge may occur in the fault zone but at relatively low rates. Consequently, the fault does not behave as a recharge boundary.

Computer Simulations

A computer ground-water model of the Dewey region was developed to aid in interpreting the test results and refining aquifer parameters. A three-dimensional ground-water flow code developed by Trescott (1975) was used for the simulations. The Inyan Kara is conceptualized as a three-layer aquifer system consisting of the Lakota (Chilson) aquifer, the Fuson aquitard and the Fall River aquifer, with model layers having uniform thicknesses of 120, 100, and 180 feet, respectively. Impervious boundaries are set above the Fall River layer and below the Lakota layer to represent the relatively impermeable shales which bound the Inyan Kara Group. The model area and finite-difference grid are shown in Figure 4. The outcrop area of the Inyan Kara represents the eastern limit of the modeled region. The remaining three sides of the model are set at sufficient distances from the test pumping well to eliminate the possibility of artificial boundary effects in model simulations. The Dewey fault zone was treated as a barrier boundary.

Simulations were made using two basic conceptual models of the Inyan Kara aquifer system to determine which model best represented observed responses during the Dewey test. For case I, uniform T and S values of 4,400 gpd/ft and 1×10^{-4} , respectively were assigned to the Lakota aquifer. A uniform T was used for this case despite evidence of a much lower transmissivity outside of the immediate test site in order to determine

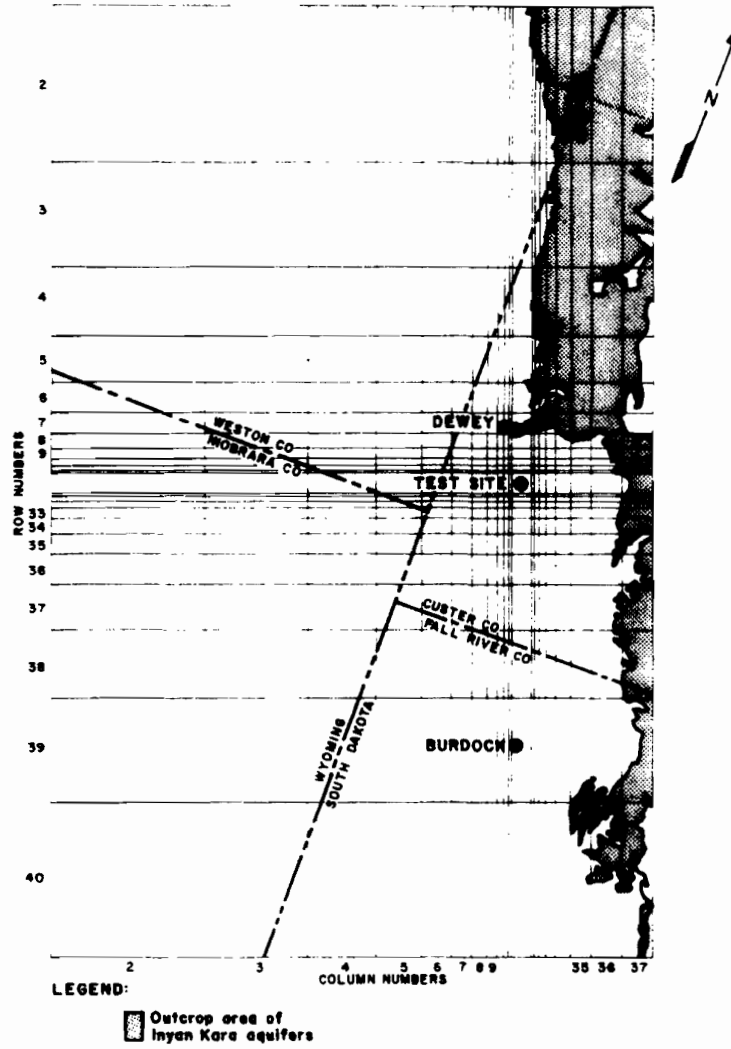

Figure 4: Ground-Water Model Grid

WR28 -2 -520 -- 128.4

whether the fault alone could account for late drawdown trends. The Fuson aquitard was assigned a uniform K'_v of 10^{-4} ft/d. The Fall River aquifer was represented by uniform T and S values of 400 gpd/ft and 10^{-4} respectively, based on the results of the Burdock tests (Boggs and Jenkins, 1980). A simulation was then made of the 11-day Dewey aquifer test using the average pumping rate of 495 gpm in an attempt to reproduce the test results. A comparison of computed and observed s-t graphs for the Lakota observation wells is shown in Figure 5. Clearly, the barrier boundary condition created by the fault does not fully account for the observed increase in drawdown rate during the latter part of the test.

In Case II, the model was modified to account for the suspected spatial variability of transmissivity in the Lakota aquifer. Geologic evidence indicates that the test site is located in an area where the Lakota is composed of an exceptionally thick coarse-grained sandstone. Outside of this locality the aquifer becomes thinner and its composition changes to finer-grained sedimentary facies. These changes are particularly evident in the area east of the site. The test results indicate a local T in the immediate site area of about 4,400 gpd/ft and a regional average of about 670 gpd/ft. These T estimates were used along with areal variations in the sandstone-shale composition of the Lakota aquifer in the site vicinity to arrive at the T distribution shown in Figure 6. Exploration borehole geophysical logs were used to estimate the relative amounts of sandstone and shale in the Lakota across the site area. The horizontal hydraulic conductivity of the sandstone is estimated at approximately 5.7×10^{-5} ft/sec based upon the near-field T estimate of 4,400 gpd/ft, an aquifer thickness of 120 feet, and the assumption that the aquifer in the immediate vicinity of the test well and closest observation wells is essentially all sandstone. The

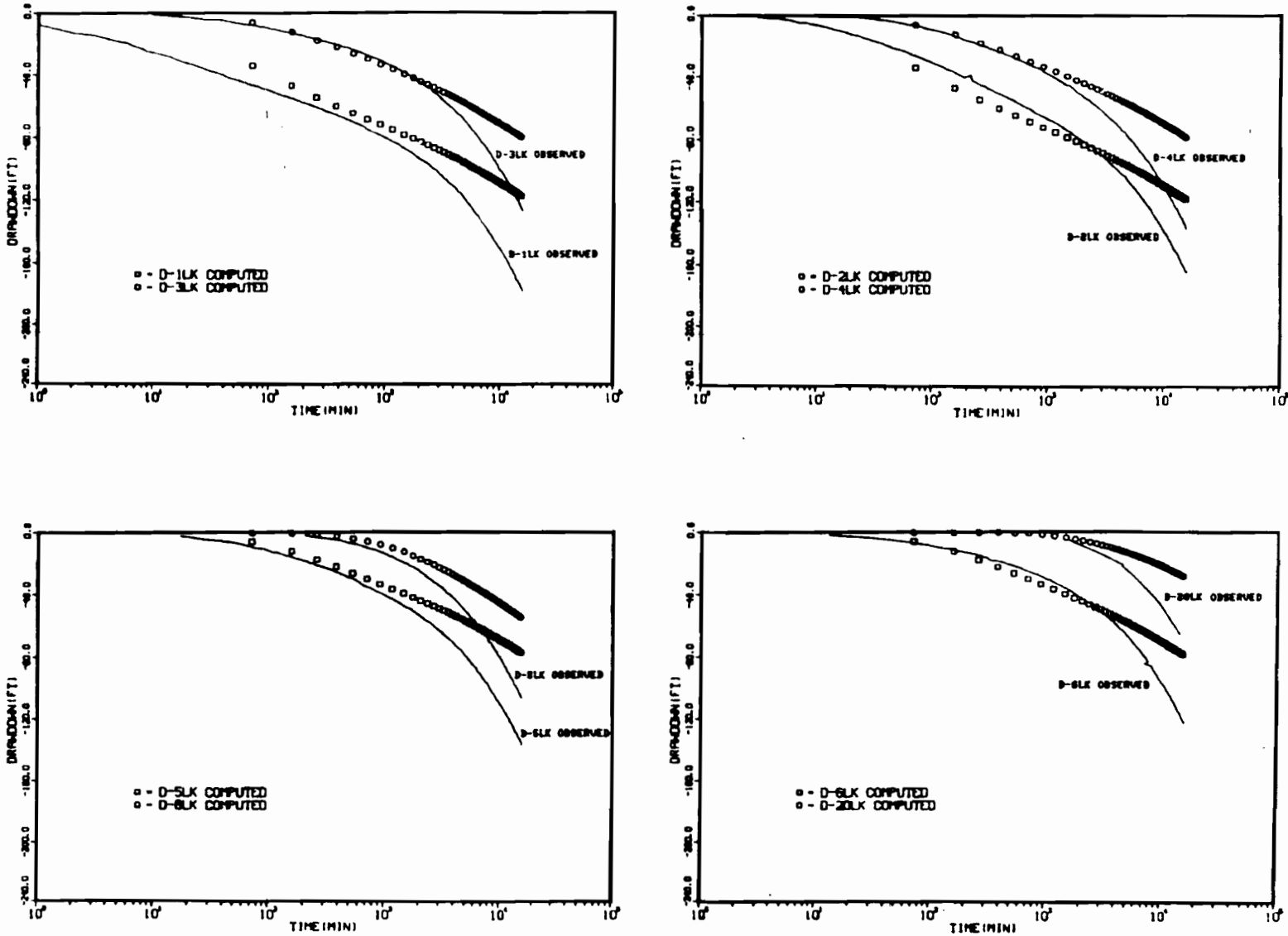

Figure 5. Comparison of Observed and Computed Drawdown, Case I

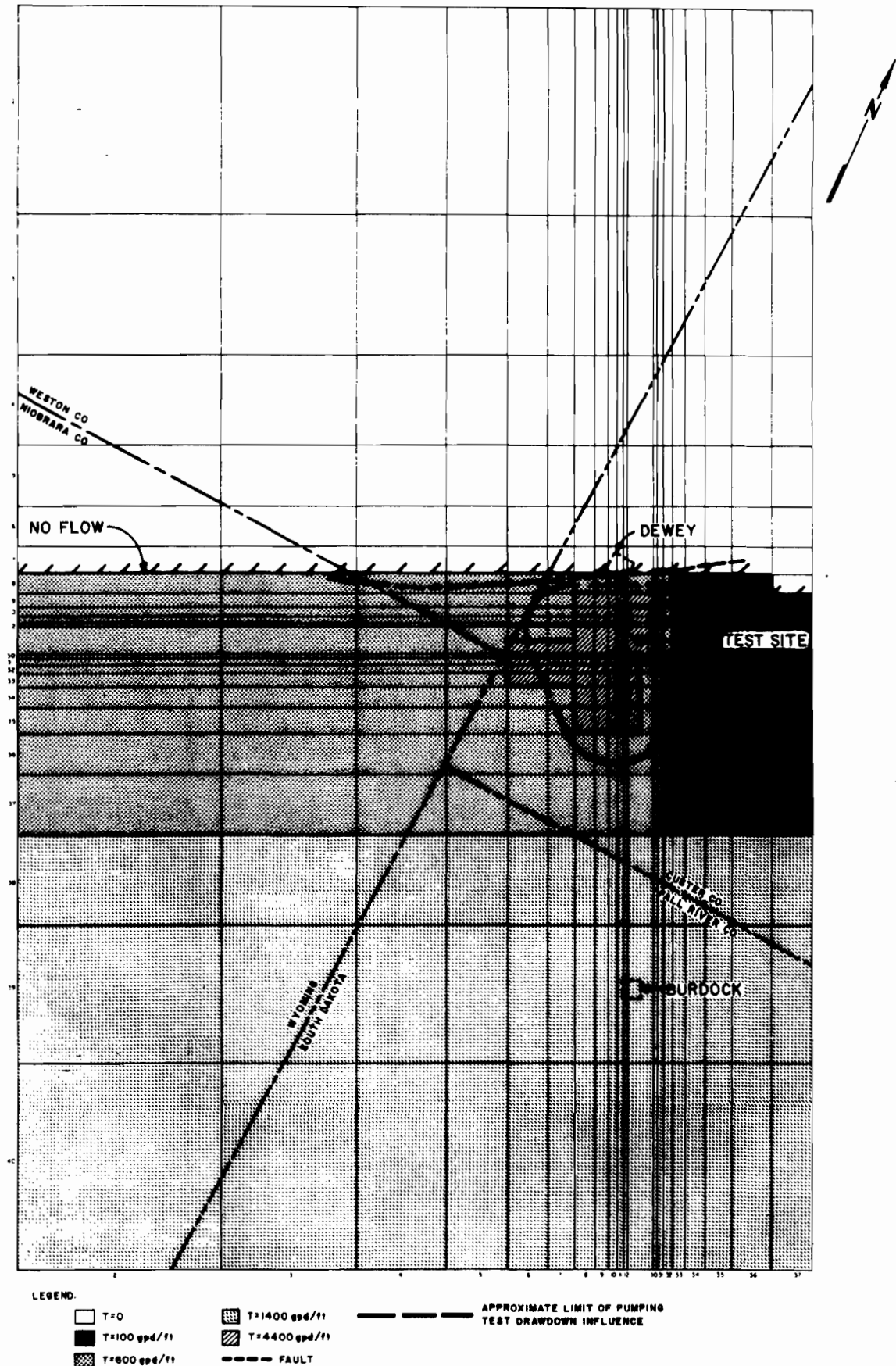

Figure 6: Transmissivity Distribution, Case II

WR28-2-520-128.6

horizontal conductivity of the shale is estimated to be about 10^{-8} ft/sec assuming (1) the measured vertical conductivity of the Fuson shale is also representative of shale in the Lakota aquifer and (2) the ratio of horizontal to vertical conductivity is about 10:1. Given the estimated horizontal conductivities for the sandstone and shale, a representative average conductivity was computed for areas having similar aquifer sandstone-shale ratios. The representative average conductivity was computed from the geometric mean of the conductivity samples as suggested by Bouwer (1969). The transmissivity of 1,400 gpd/ft assigned to the southern portion of the model is based on results of the Burdock aquifer test. Note that although an attempt was made to assign realistic transmissivity values to the entire model region, model simulation results are mainly affected by the transmissivity distribution within the observed limits of influence of the 11-day aquifer test as indicated in Figure 6. Outside of this region the model is relatively insensitive to the assigned T values.

The Case II simulation results are shown in Figure 7. The agreement between the computed and observed drawdown trends in the Lakota wells is quite good overall. At least part of the discrepancy between observed and computed responses in these units is due to the fact that computed hydraulic heads are average values over the thickness of the aquifer or aquitard layer.

The observed drawdown trends could, perhaps, be reproduced using some alternative T distribution without the barrier boundary condition assumed for the Dewey fault. However, if the fault did not represent a barrier, substantial pressure changes should have been observed during the test in the private Lakota wells located north of the fault. These wells are located at approximately the same radial distance as observation well

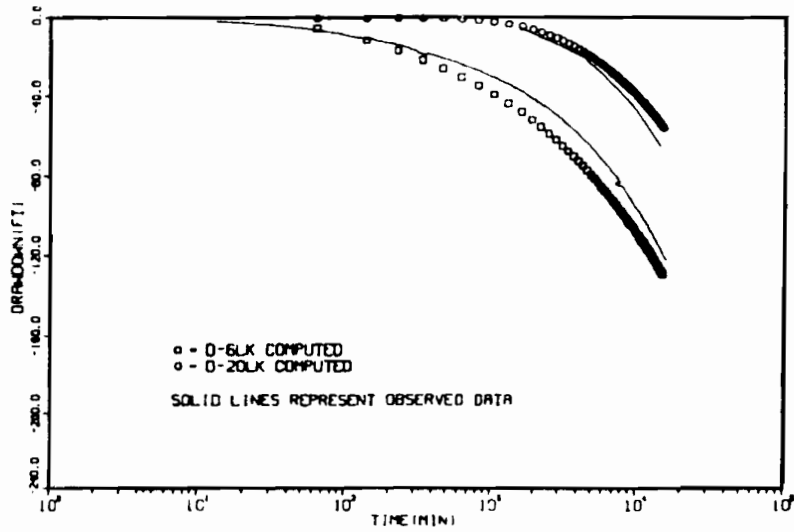
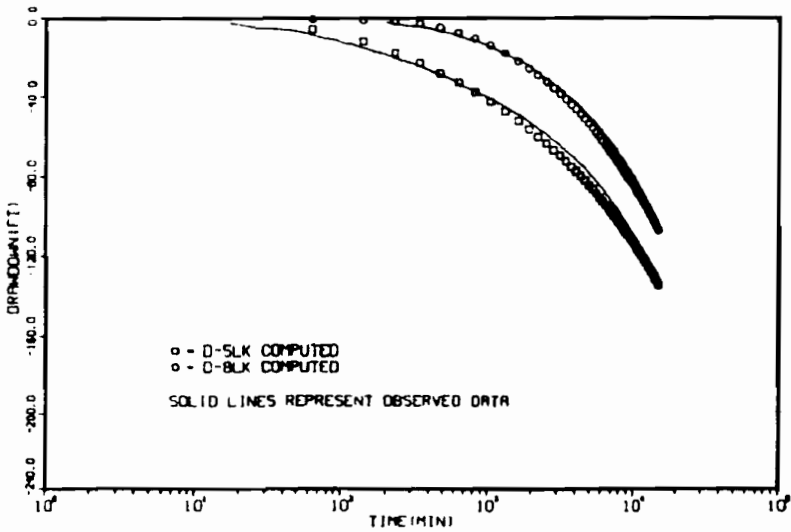
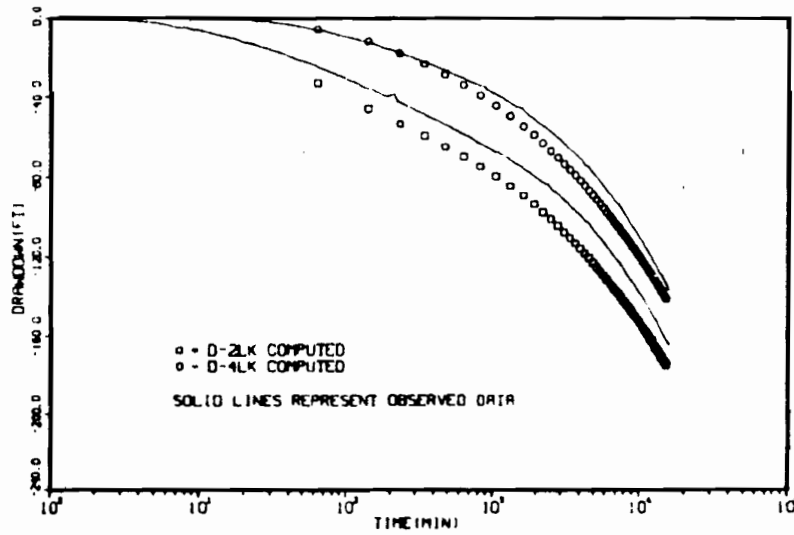
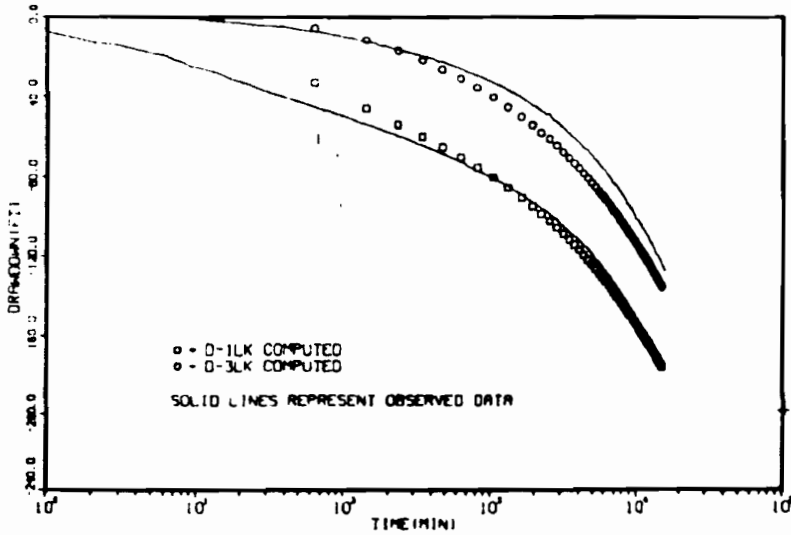

Figure 7. Comparison of Observed and Computed Drawdown, Case II

WR28-2-520-128.7

D-20LK which exhibited 66 feet of drawdown at the end of the test. As no drawdown occurred in these wells, it is concluded that the Dewey fault represents a hydrogeologic barrier.

The Case II simulation results support the concept of the Lakota as a patchy aquifer of relatively low-transmissivity overall but having within it localized zones of substantially higher transmissivity. The proposed mine site lies within one of these high transmissivity localities. Although the T distribution used in the Case II model is based upon reasonable assumptions, it is considered only an approximation of actual conditions in the test site area. Nevertheless, this approximation is adequate for assessing long-term mine depressurization impacts. The significance of the Case II model result is that it provides an interpretation of the test results which is consistent with what is known or suspected about the hydrogeologic conditions in the site region.

CONCLUSIONS

Hydrogeologic investigations in the Dewey area indicate that the proposed mine site lies within an area where the Lakota Formation is composed of relatively thick permeable sandstone. The transmissivity of the Lakota aquifer in this locality is estimated to be approximately 4,400 gpd/ft. Storativity of the aquifer is about 10^{-4} . Outside of this area the Lakota transmissivity decreases substantially. The variation in transmissivity over the region is consistent with geologic evidence of thinning of the Lakota sandstone away from the test site and a change to finer-grained sand and shale facies. The significance of this condition is that long-term mine depressurization rates and drawdown response in the Dewey vicinity will be

governed by the lower transmissivity material. As a result, dewatering rates will be lower and the areal extent of drawdown impacts smaller than if the higher transmissivity prevailed.

There is evidence that hydraulic communication between the Fall River and Lakota aquifers occurred during the Dewey test. However, the degree of interconnection between these units is substantially less than that observed at the Burdock test site. The vertical hydraulic conductivity of the intervening Fuson aquitard estimated from the Dewey test data is approximately 10^{-4} ft/d. This value is about an order of magnitude lower than the estimate obtained at Burdock. The difference is somewhat surprising in that the Fuson aquitard is thinner in the Dewey area than at Burdock. A possible explanation may be that the direct avenues of hydraulic communication (e.g., numerous open pre-TVA exploration boreholes) believed to exist at Burdock, are not present in the Dewey area.

Evaluation of the drawdown responses recorded in test wells and private wells during the aquifer test and review of existing subsurface geologic data indicates that the Dewey fault zone acts as a hydrogeologic barrier to horizontal ground-water movement between the Inyan Kara aquifers located on opposite sides of the fault zone. Some upward vertical recharge to the Inyan Kara may occur in the fault zone as suggested by Gott, et al. (1968). However, rate of recharge from this source must be relatively small, otherwise recharge effects would be apparent in the aquifer test results and in the configuration of the steady-state potentiometric surface. It is expected that the fault will significantly reduce mining drawdown impacts on ground-water supplies located north of the fault zone.

3. The model should be calibrated by adjustment of hydraulic parameters to reproduce the existing steady-state potentiometric surface shown in Figure 1. The hydraulic properties for the Inyan Kara units measured at the Dewey and Burdock test sites should be held constant in the calibration process, while parameter adjustments are made in other areas to obtain a reasonable match between the computed and observed potentiometric levels. An estimate of net ground-water recharge can be obtained from the calibrated model by assigning observed potentiometric head values to the model nodes which lie within the aquifer recharge (outcrop) area. The aquifer recharge fluxes may be incorporated directly into the model to more accurately represent drawdown conditions in the outcrop areas during mine depressurization simulations.

4. Significant pumping stresses on the Inyan Kara aquifers other than the TVA mining operations should be identified and incorporated into the model.

REFERENCES

- Boggs, J. M., and A. M. Jenkins, 1980, "Analysis of Aquifer Tests Conducted at the Proposed Burdock Uranium Mine Site, Burdock, South Dakota," TVA Report No. WR28-1-520-109.
- Bouwer, H., 1969, "Planning and Interpreting Soil Permeability Measurements," ASCE Journal of Irrigation and Drainage Division, V. 95, No. IR3, pp. 391-402.
- Gambolati, G., 1974, "Second-Order Theory of Flow in Three-Dimensional Deforming Media," Water Resources Research, V. 10, No. 6, pp. 1217-1228.
- Gott, G. B., D. E. Wolcott, and C. G. Bowles, 1974, "Stratigraphy of the Inyan Kara Group and Localization of Uranium Deposits, Southern Black Hills, South Dakota and Wyoming," USGS Prof. Paper 763.
- Trescott, P. C., 1975, "Documentation of Finite-Difference Model for Simulation of Three-Dimensional Ground-Water Flow," USGS Open File Report 75-438.
- Walton, W. C., 1970, Groundwater Resource Evaluation, McGraw-Hill, New York.

FIGURE A-1: DRAWDOWN GRAPH FOR WELL D-PW

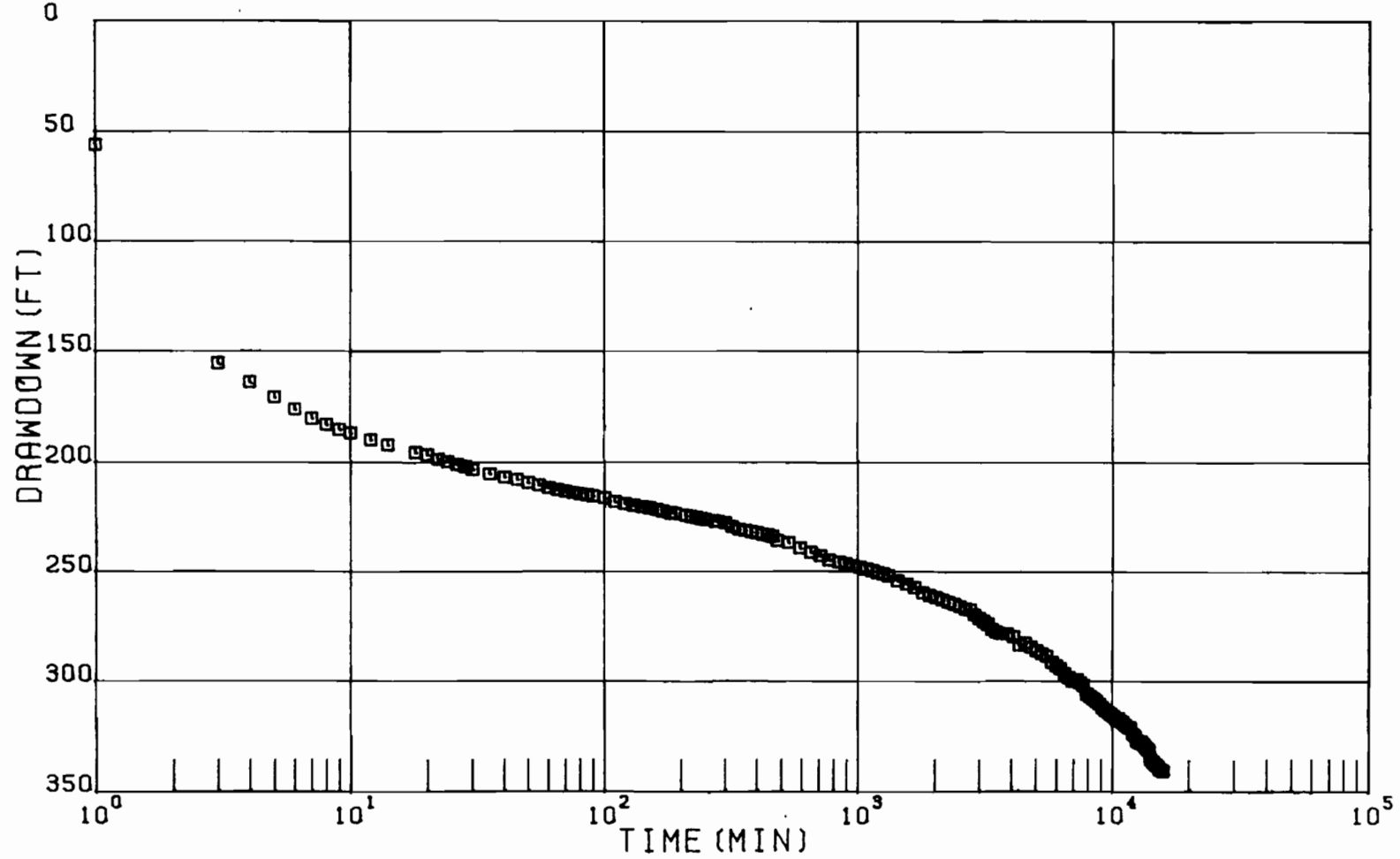

WR28-2-520-128.A-1

Dewey-Burdock GDP
June 2012

3.7-B-836

Appendix 3.7-B

FIGURE A-2: DRAWDOWN GRAPH FOR D-1 WELL GROUP

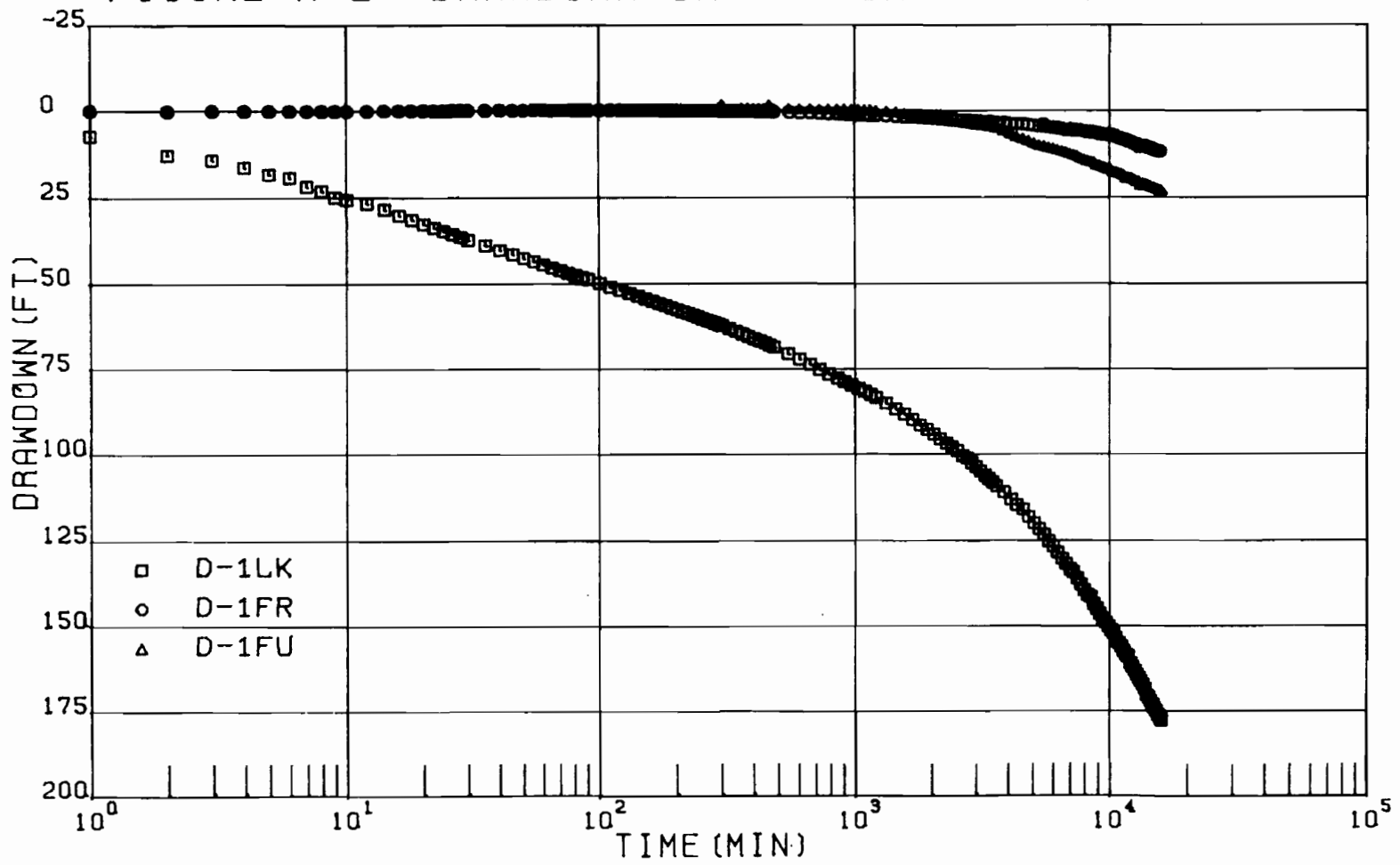

WR20-2-020-128.A-2

Dewey-Burdock GDP
June 2012

3.7-B-837

Appendix 3.7-B

WR28-2-520-128, A-3

Dewey-Burdock GDP
June 2012

3.7-B-838

Appendix 3.7-B

FIGURE A-3: DRAWDOWN GRAPH FOR WELL D-2LK

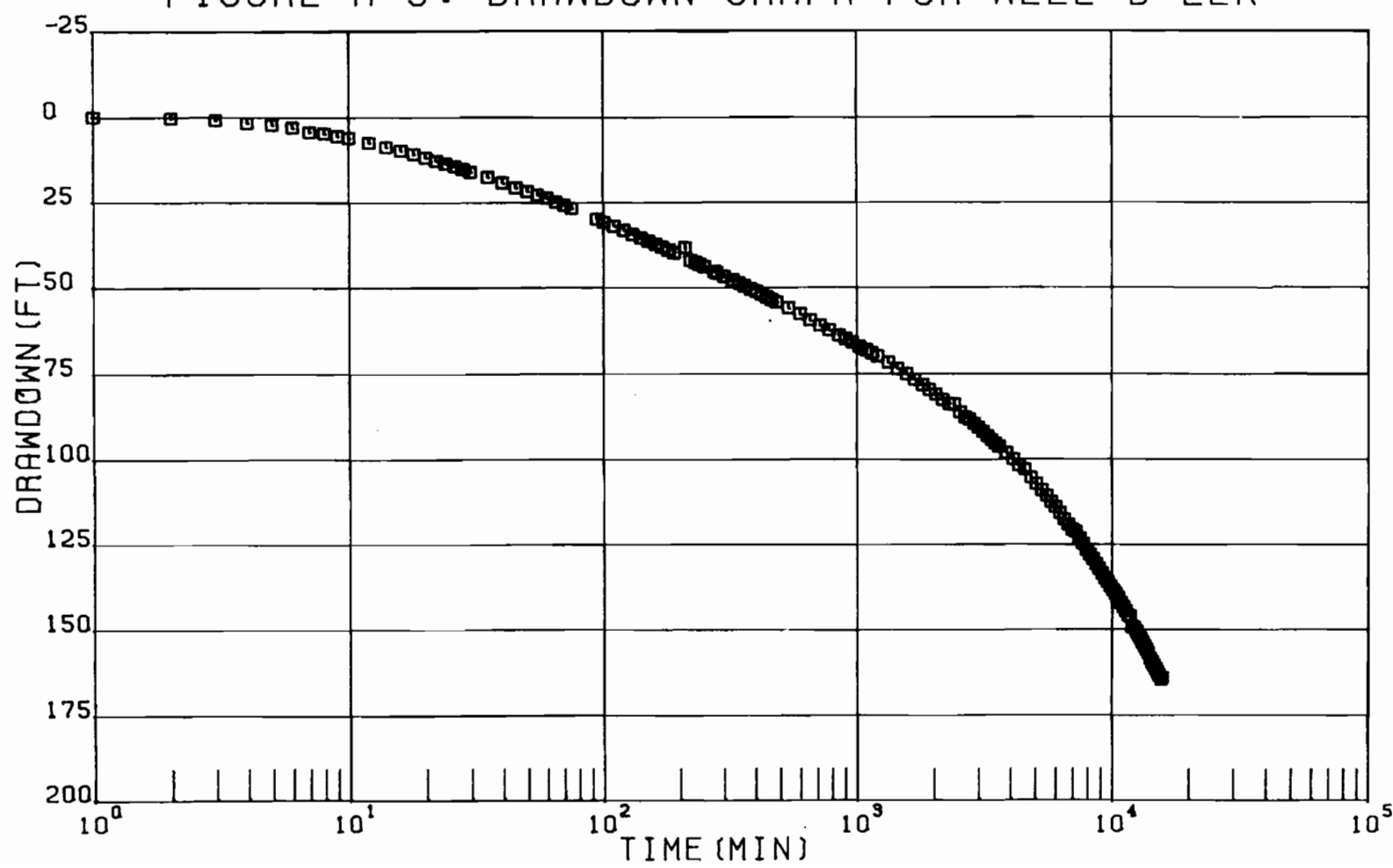
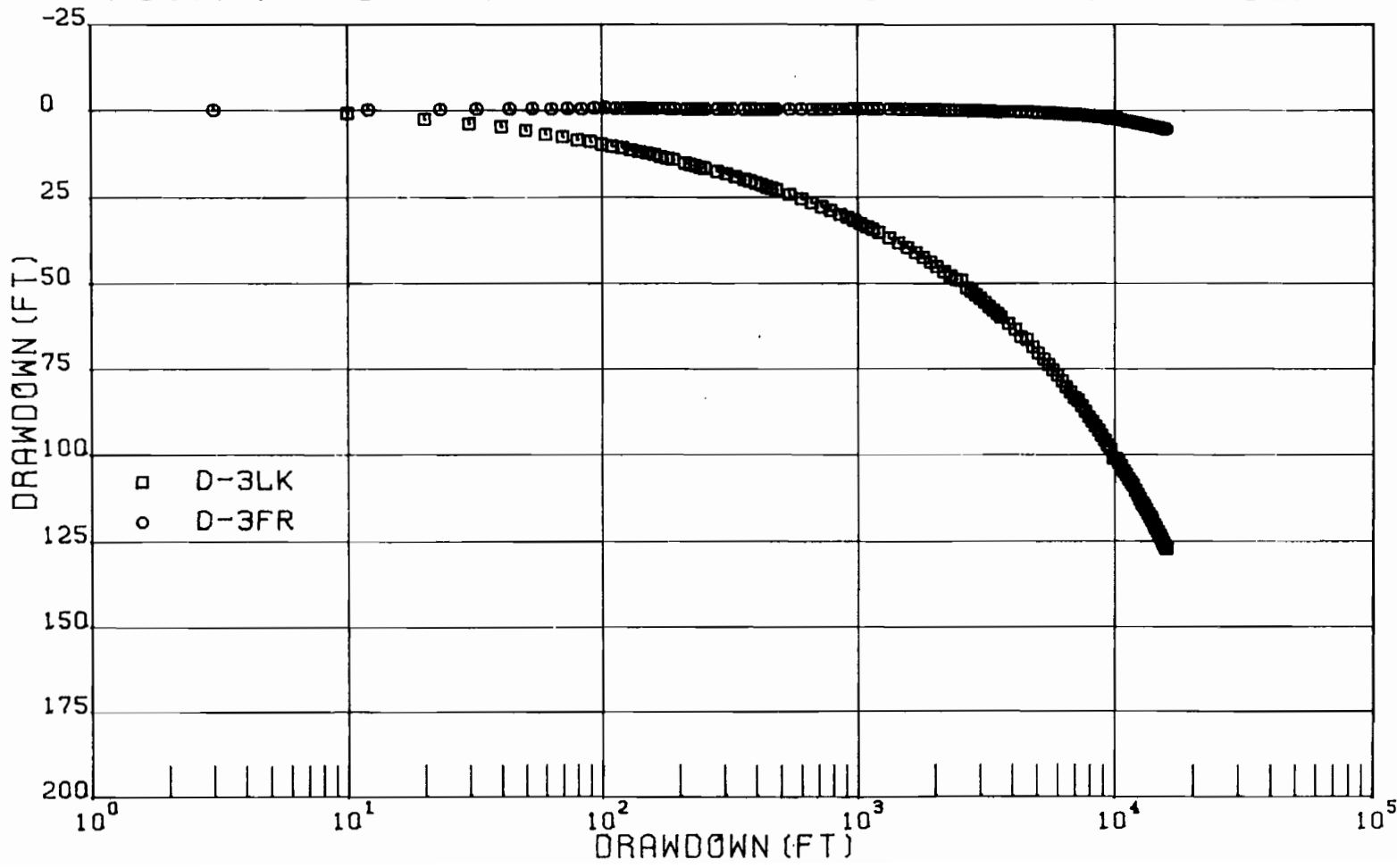

FIGURE A-4: DRAWDOWN GRAPH FOR D-3 WELL GROUP



WR28-2 -520 -128.A-4

Dewey-Burdock GDP
June 2012

3.7-B-839

Appendix 3.7-B

FIGURE A-5: DRAWDOWN GRAPH FOR D-4 WELL GROUP

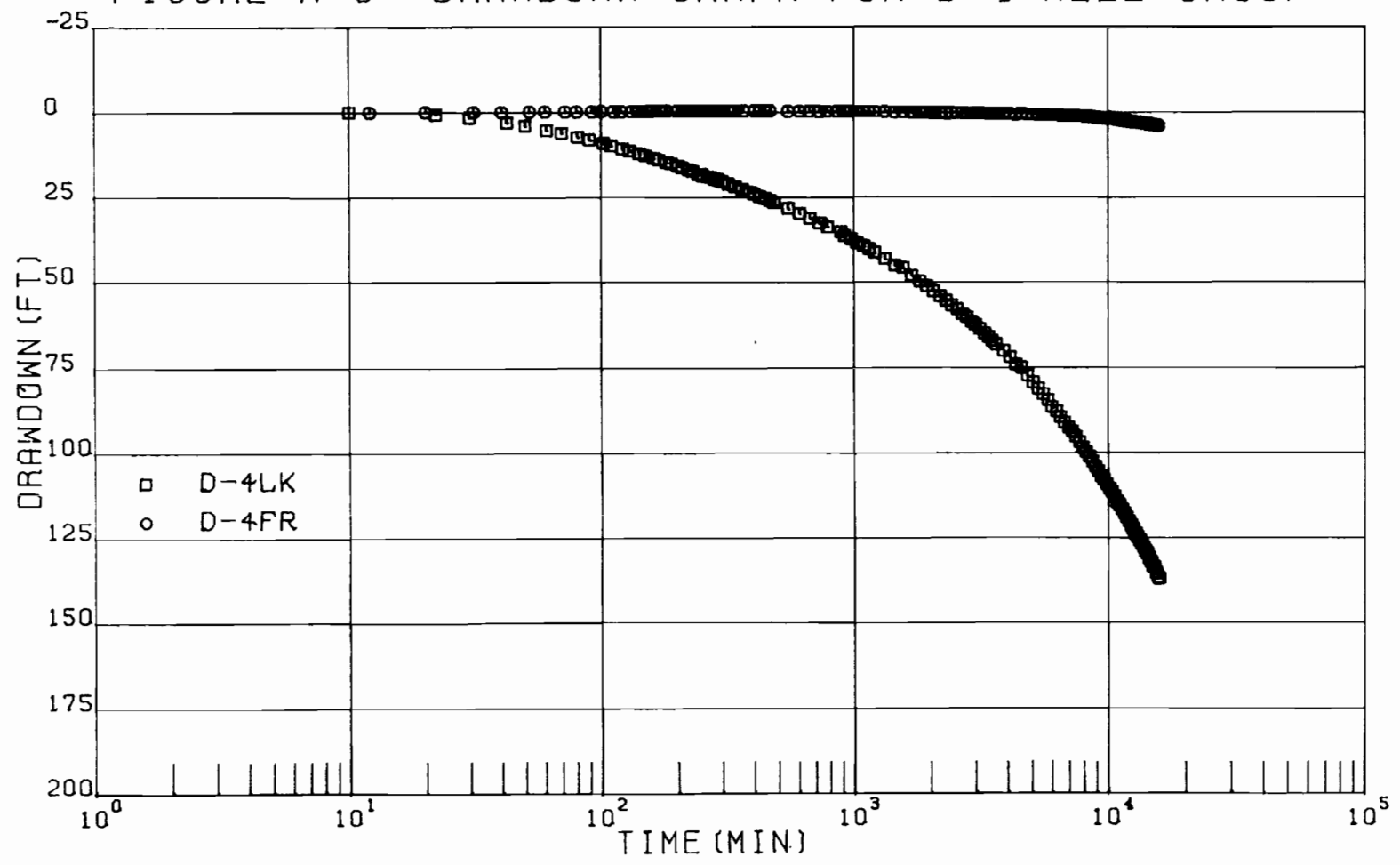

WR28 - 2 - 520 - 128. A - 5

Dewey-Burdock GDP
June 2012

3.7-B-840

Appendix 3.7-B

FIGURE A-6: DRAWDOWN GRAPH FOR WELL D-5LK

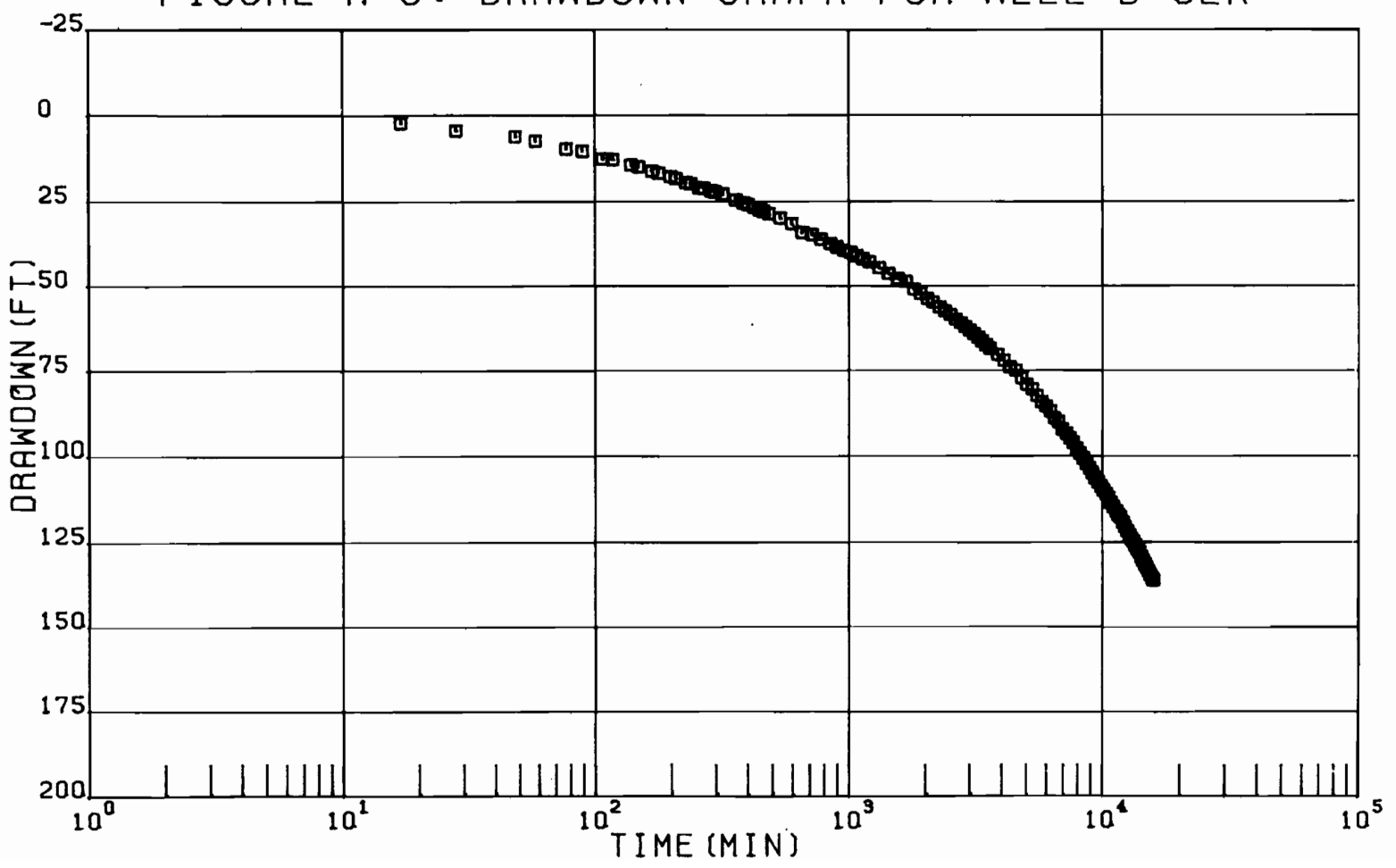

WR28-2-520-128.A-6

Dewey-Burdock GDP
June 2012

3.7-B-841

Appendix 3.7-B

WR28-2-520-128.A-7

Dewey-Burdock GDP
June 2012

3.7-B-842

Appendix 3.7-B

FIGURE A-7: DRAWDOWN GRAPH FOR WELL D-6LK

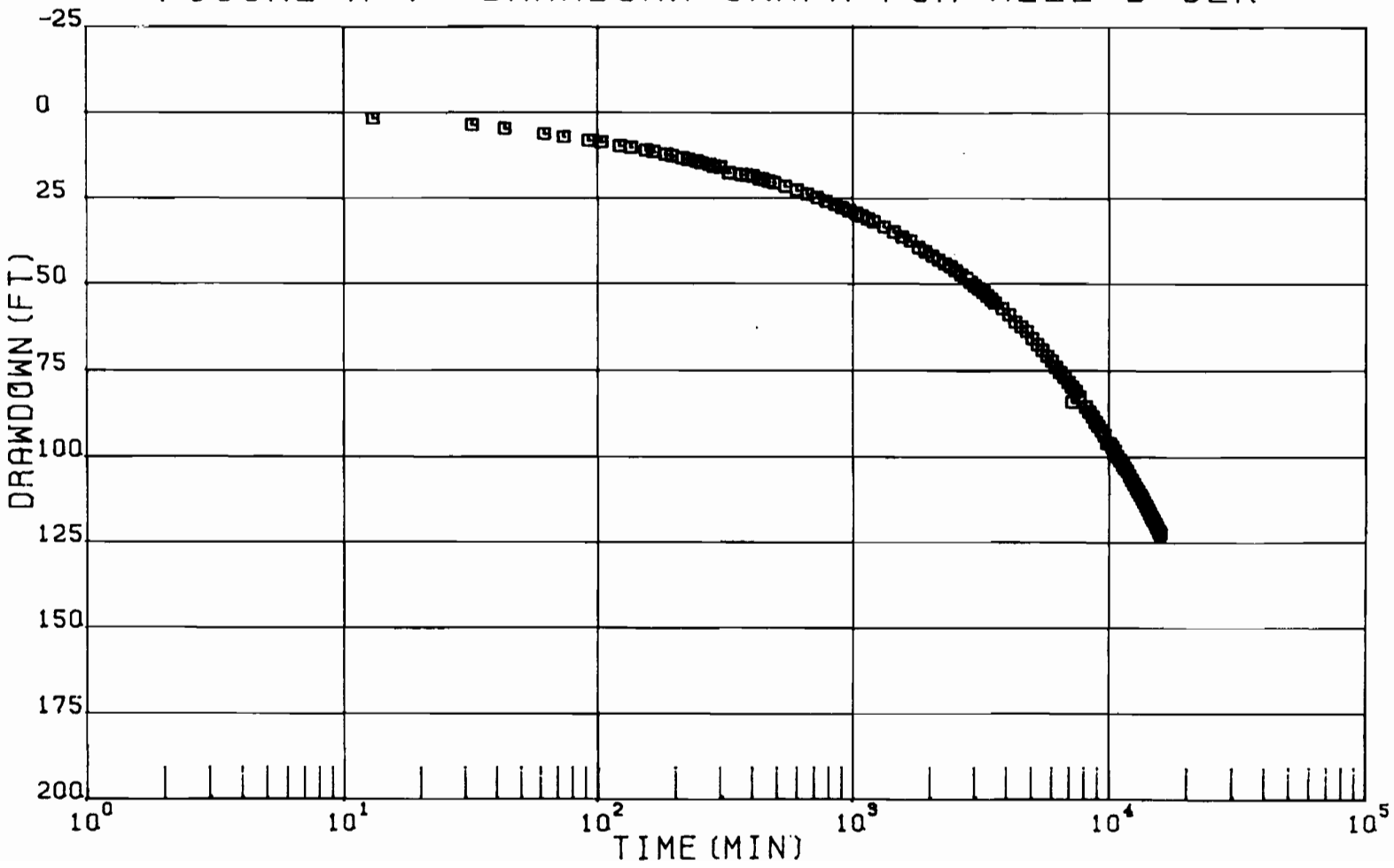
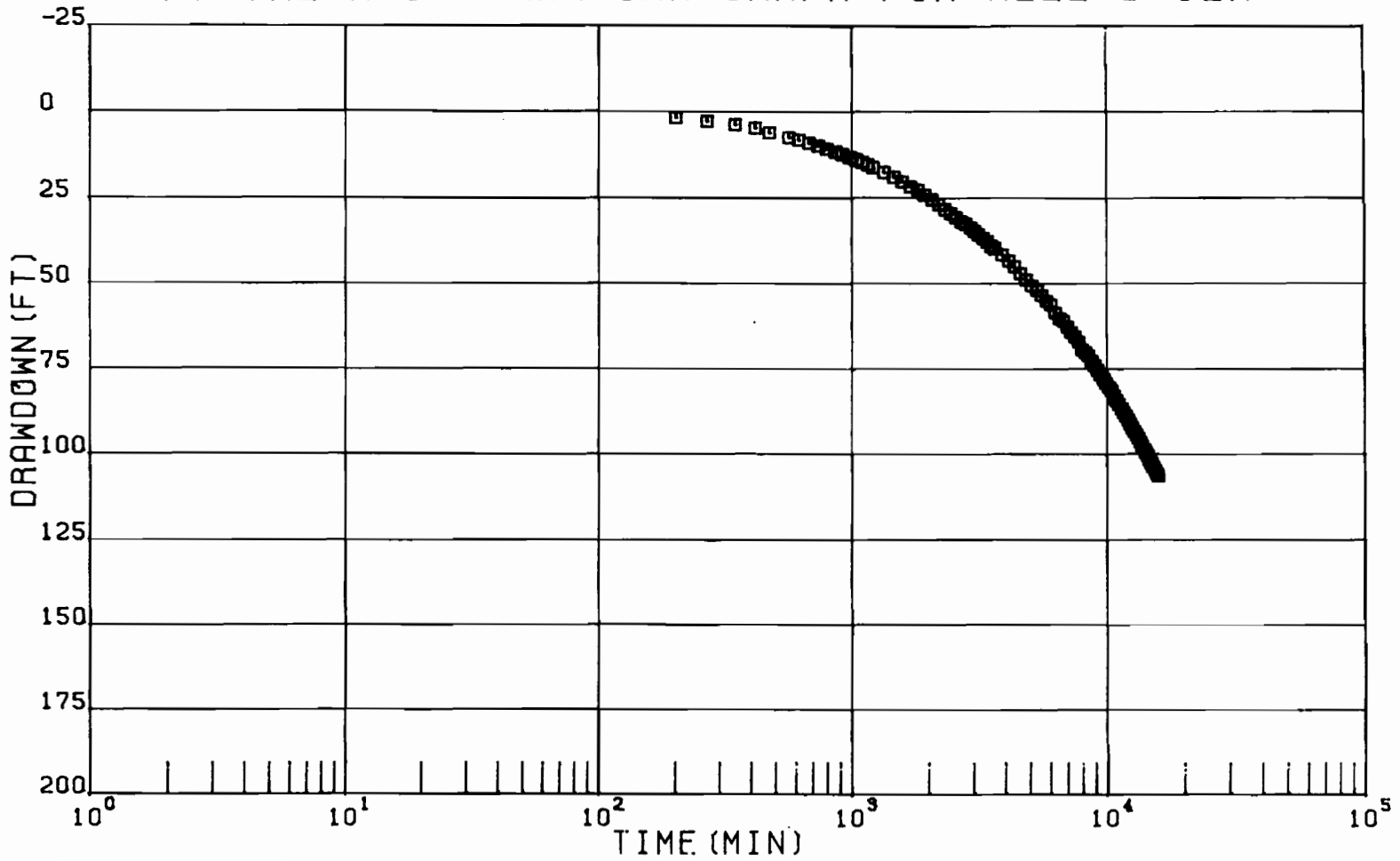

FIGURE A-8: DRAWDOWN GRAPH FOR WELL D-8LK



WR28.-2-520-128.A-8

Dewey-Burdock GDP
June 2012

3.7-B-843

Appendix 3.7-B

FIGURE A-9: DRAWDOWN GRAPH FOR WELL D-20LK

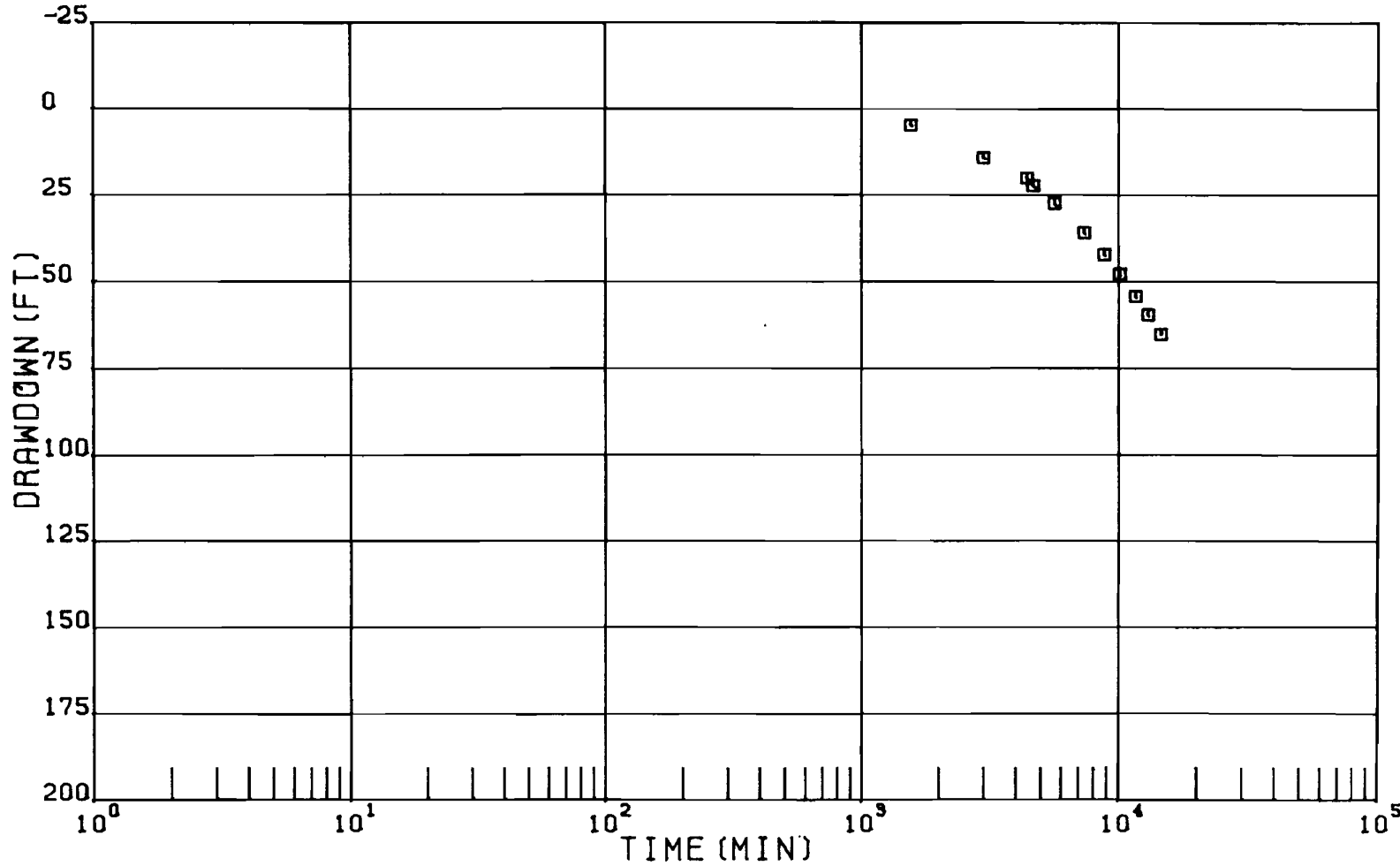

W128-2-520-128.A-9

Dewey-Burdock GDP
June 2012

3.7-B-844

Appendix 3.7-B



APPENDIX B

LOGARITHMIC TIME-DRAWDOWN GRAPHS

FIGURE B-1: DRAWDOWN GRAPH FOR WELL D-PW

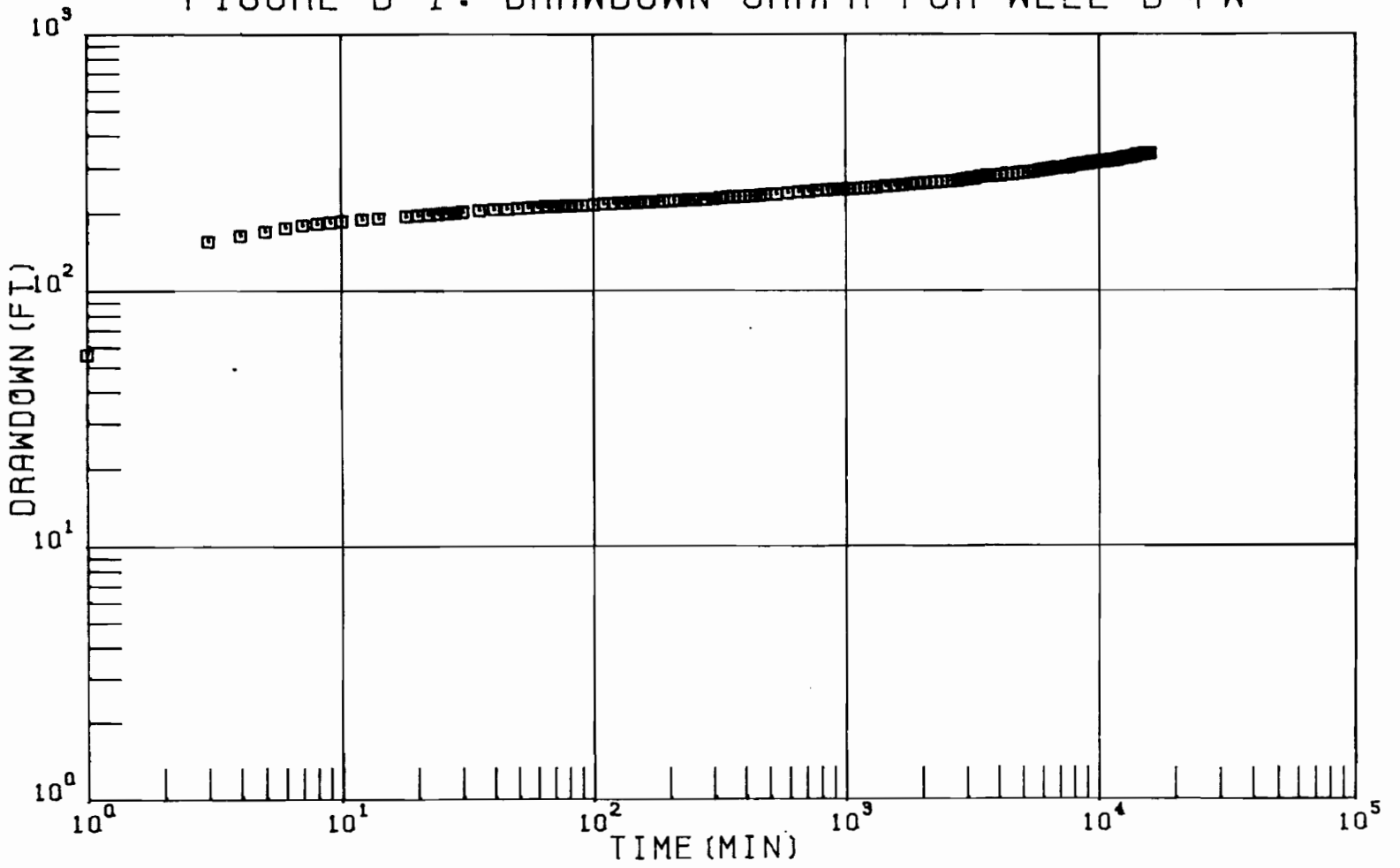



WR28-2-520-128.B-2

Dewey-Burdock GDP
June 2012

FIGURE B-2: DRAWDOWN GRAPH FOR D-1 WELL GROUP

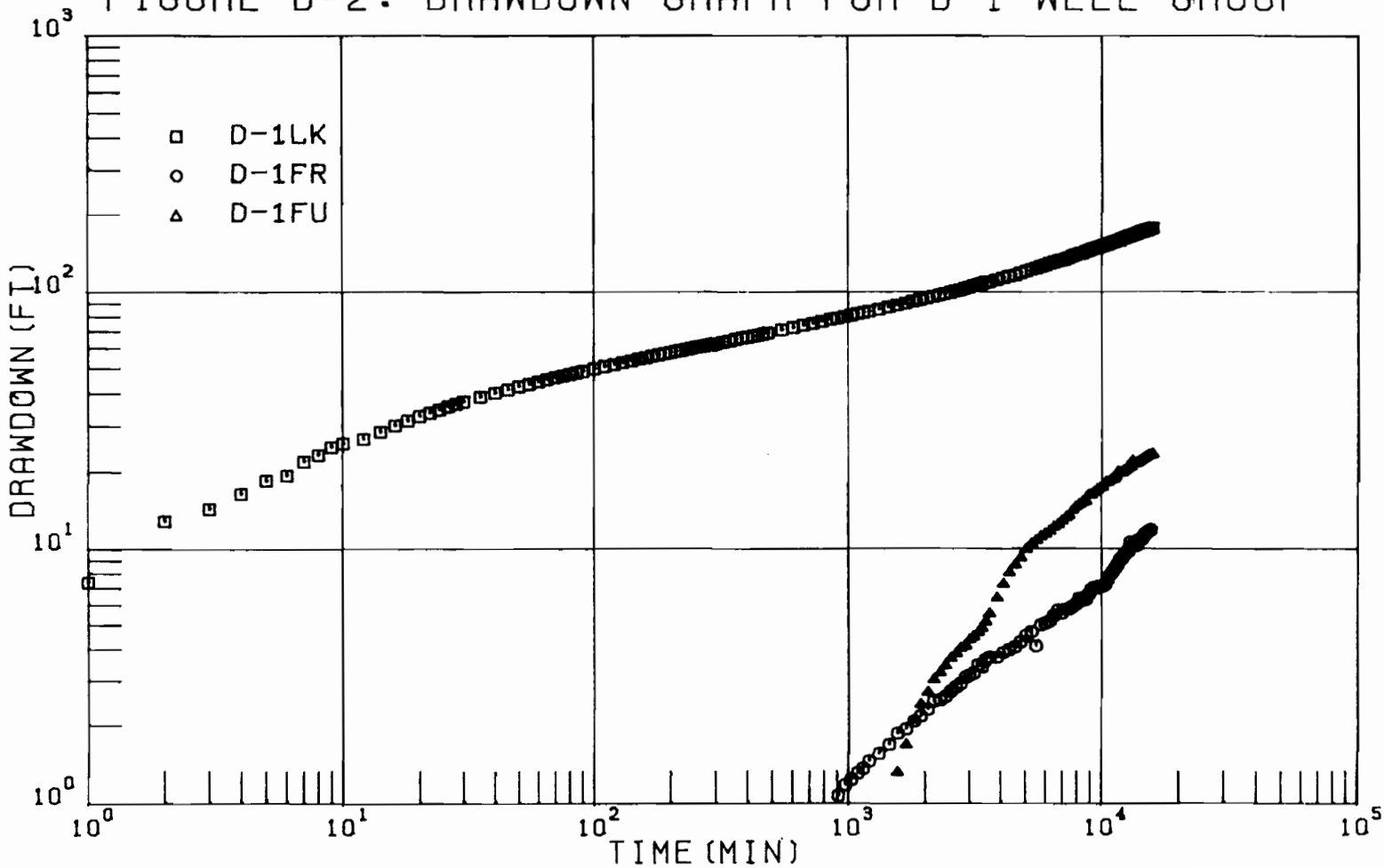

3.7-B-847

Appendix 3.7-B

FIGURE B-3: DRAWDOWN GRAPH FOR WELL D-2LK

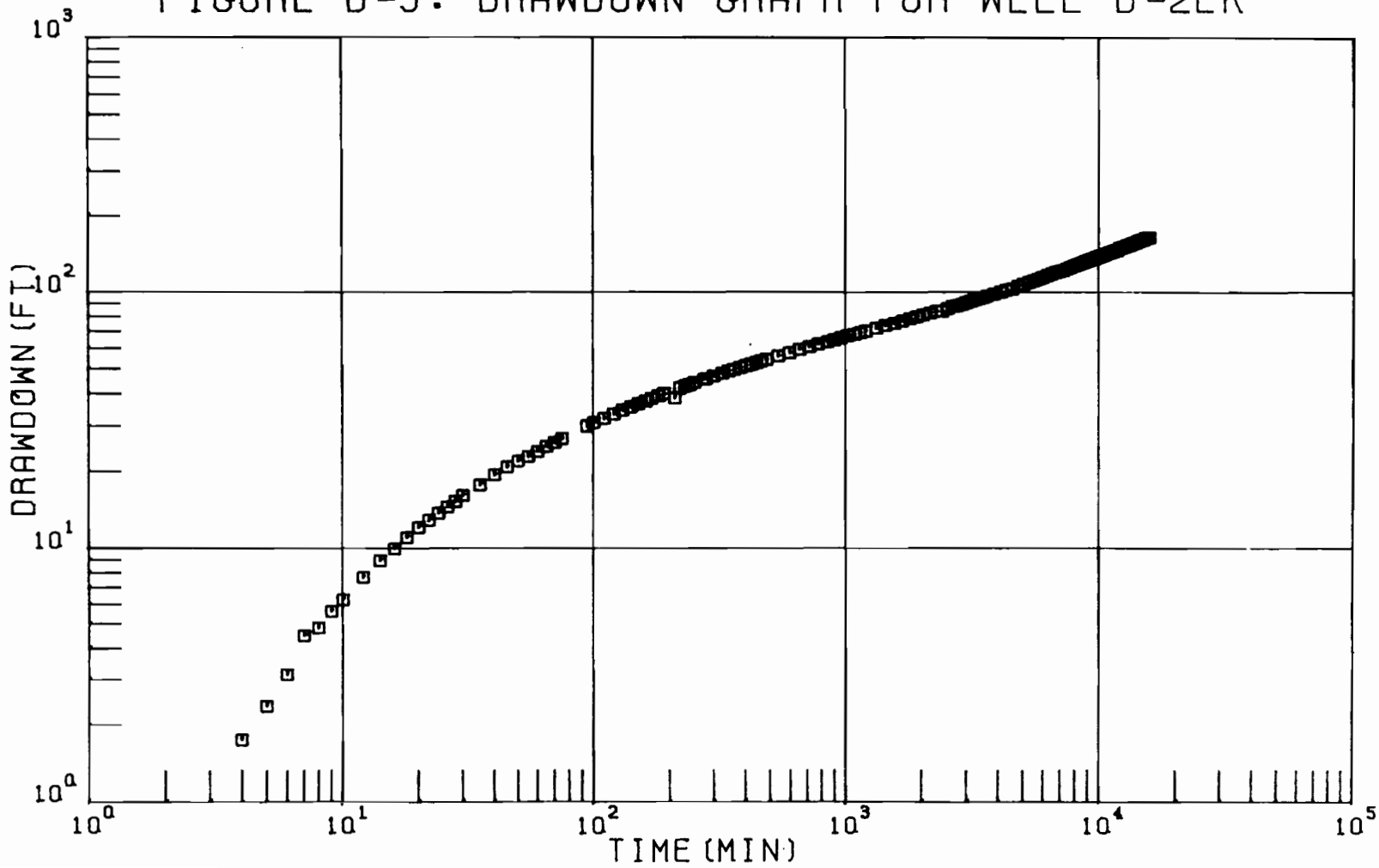

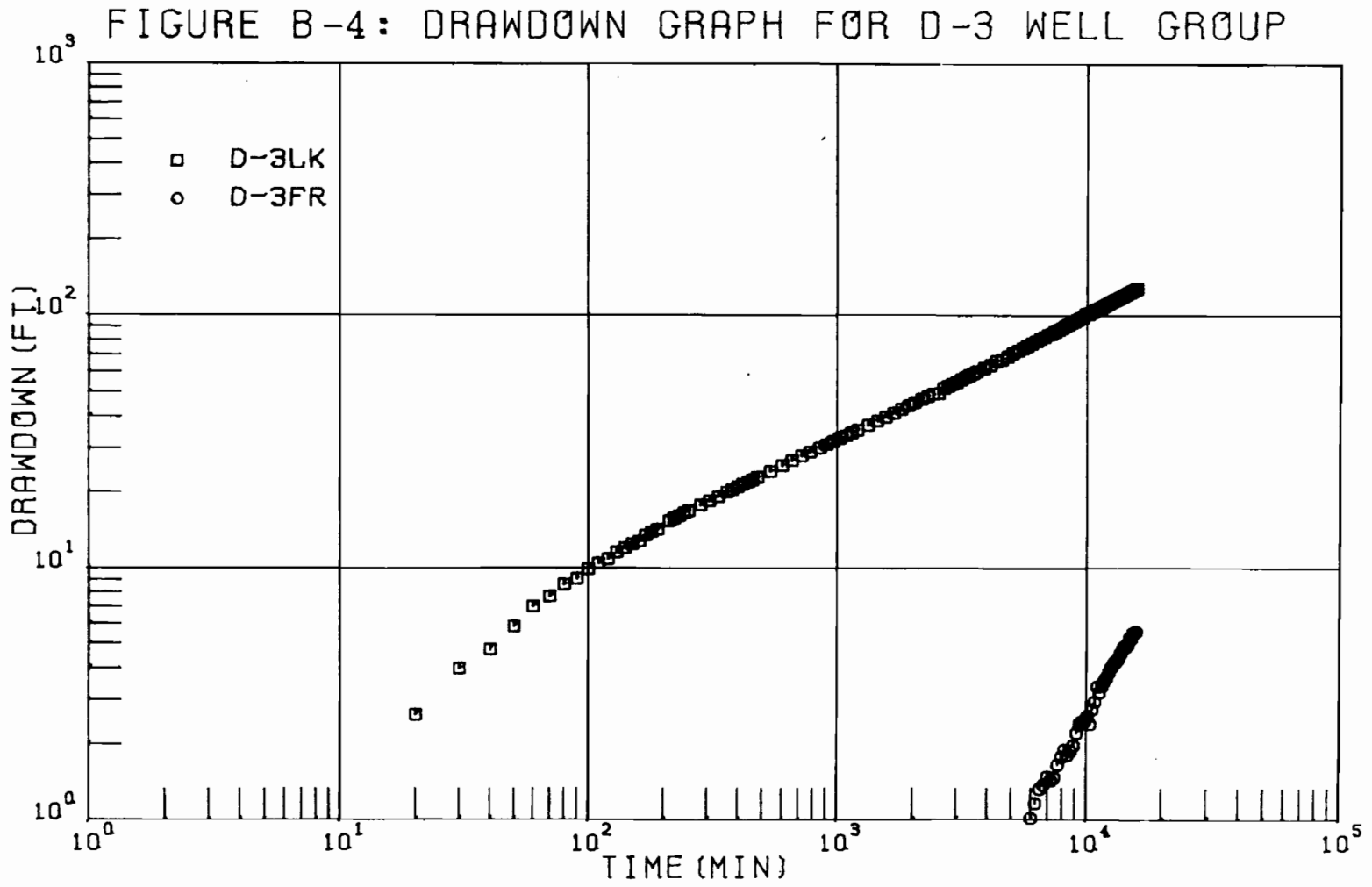



WR28-2-520-128.B-5

FIGURE B-5: DRAWDOWN GRAPH FOR D-4 WELL GROUP

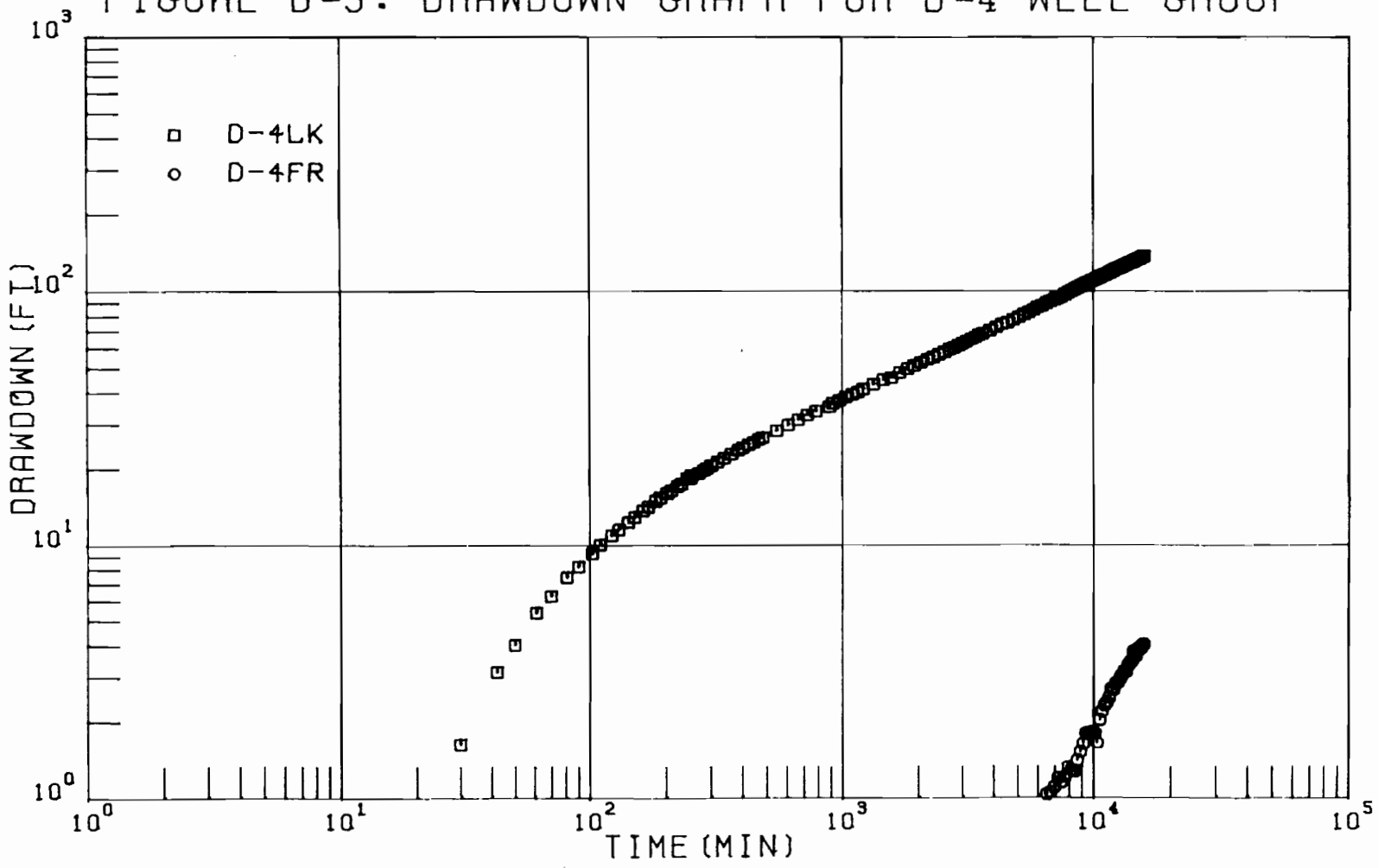
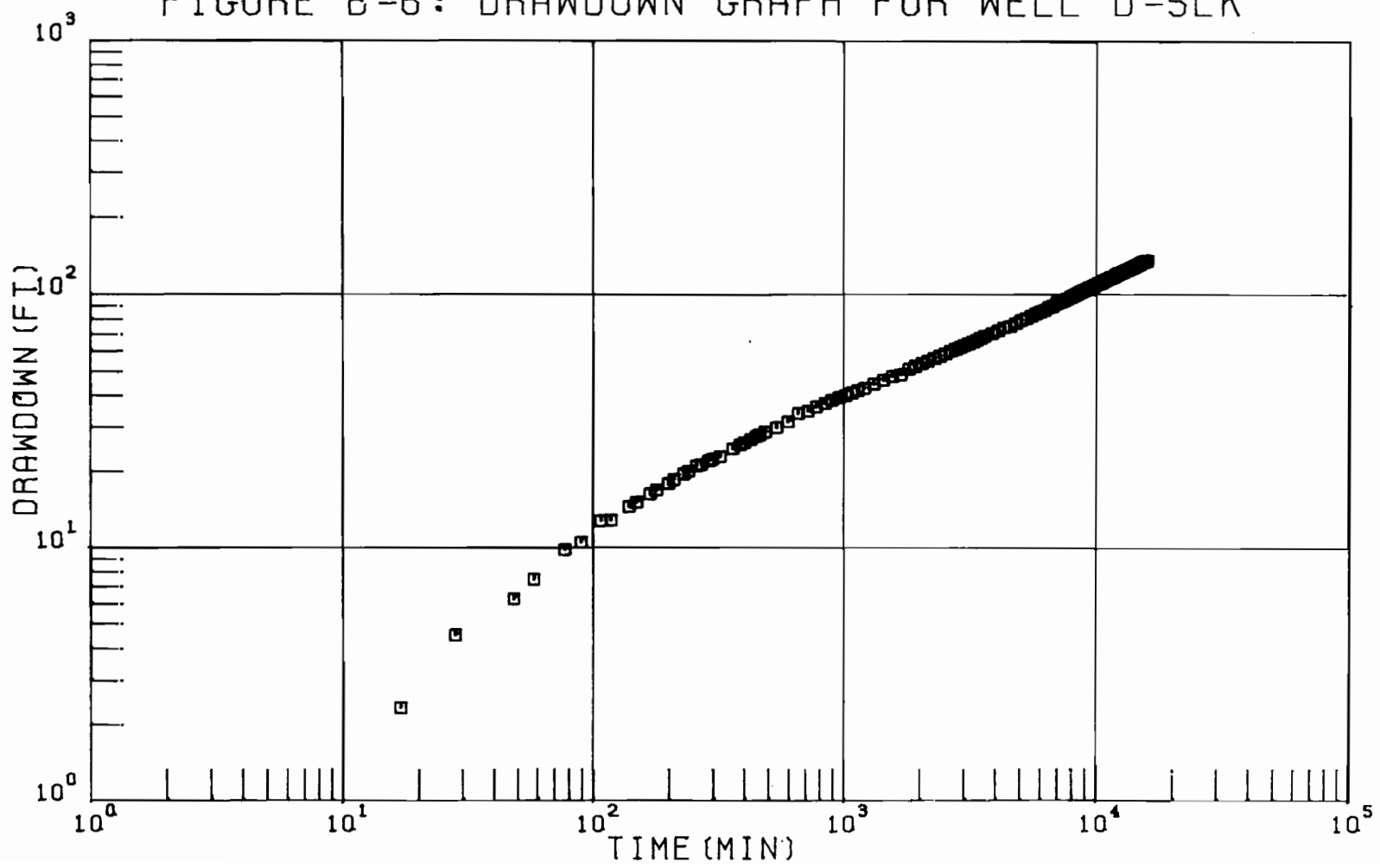
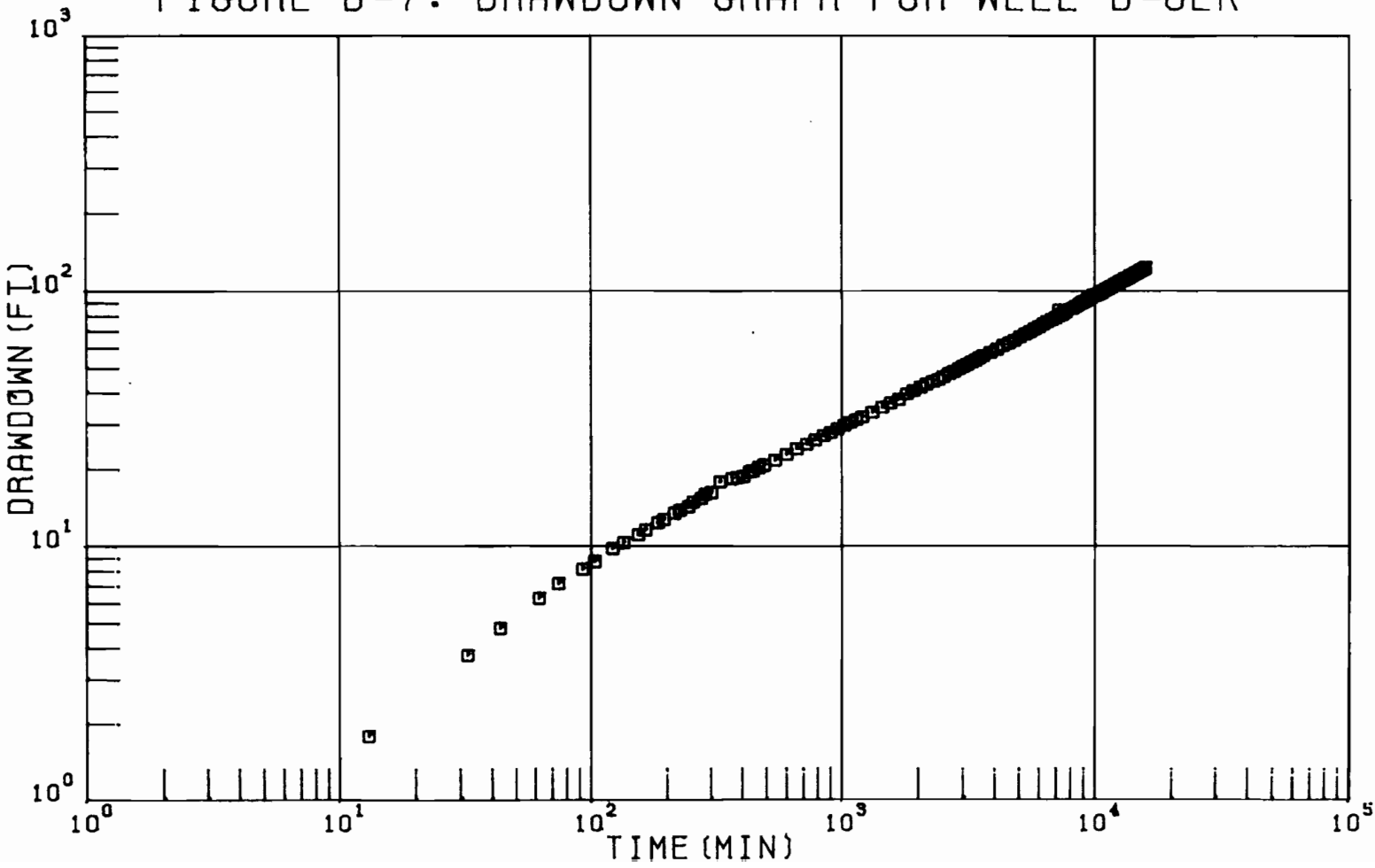

FIGURE B-6: DRAWDOWN GRAPH FOR WELL D-5LK



Wn28-2-020-128.B-6

FIGURE B-7: DRAWDOWN GRAPH FOR WELL D-6LK



WR28-2-520-128.B-7

Dewey-Burdock GDP
June 2012

3.7-B-852

Appendix 3.7-B

FIGURE B-8: DRAWDOWN GRAPH FOR WELL D-8LK

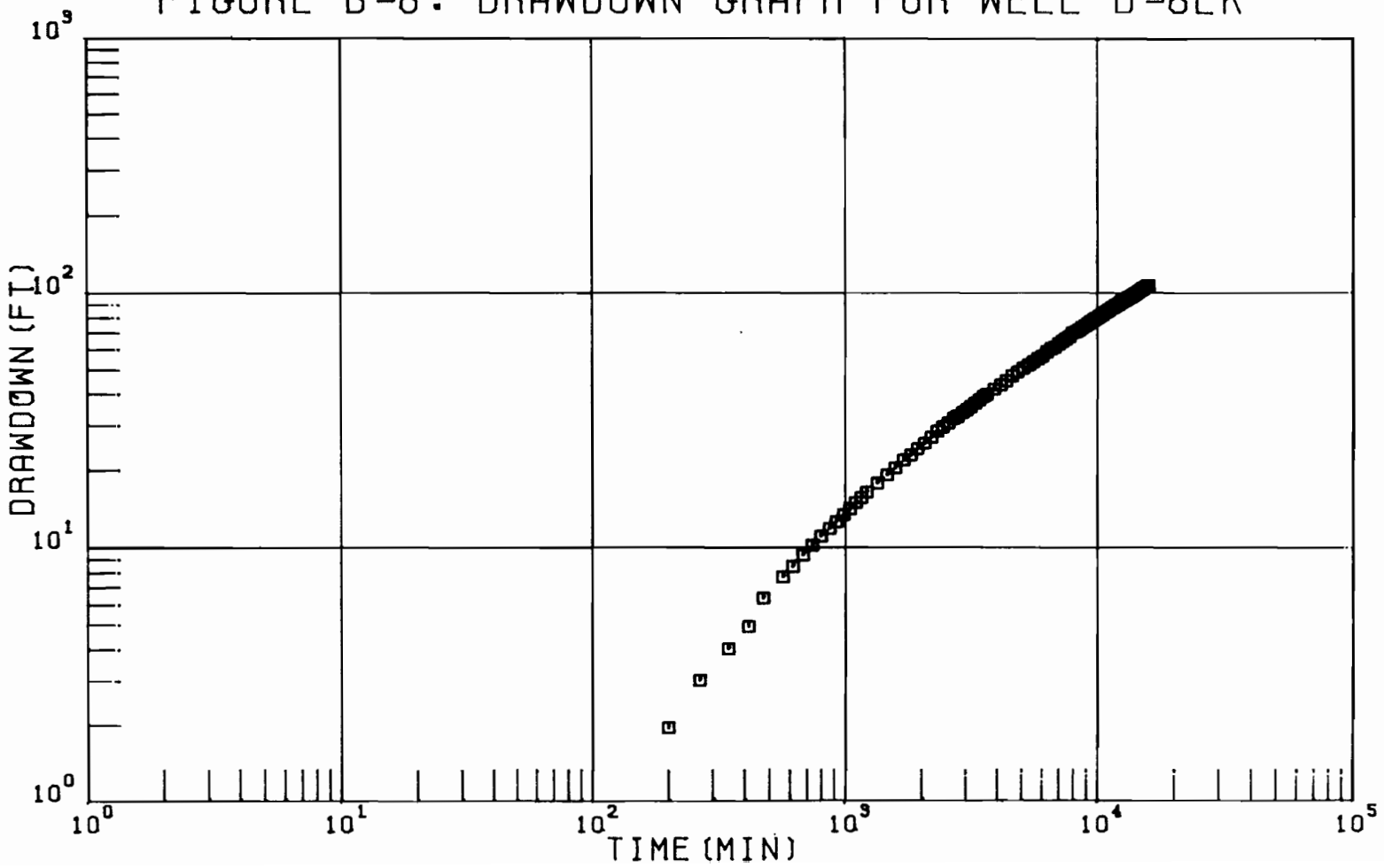

WR28-2-520-128.B-8

Dewey-Burdock GDP
June 2012

3.7-B-853

Appendix 3.7-B



FIGURE B-9: DRAWDOWN GRAPH FOR WELL D-20LK

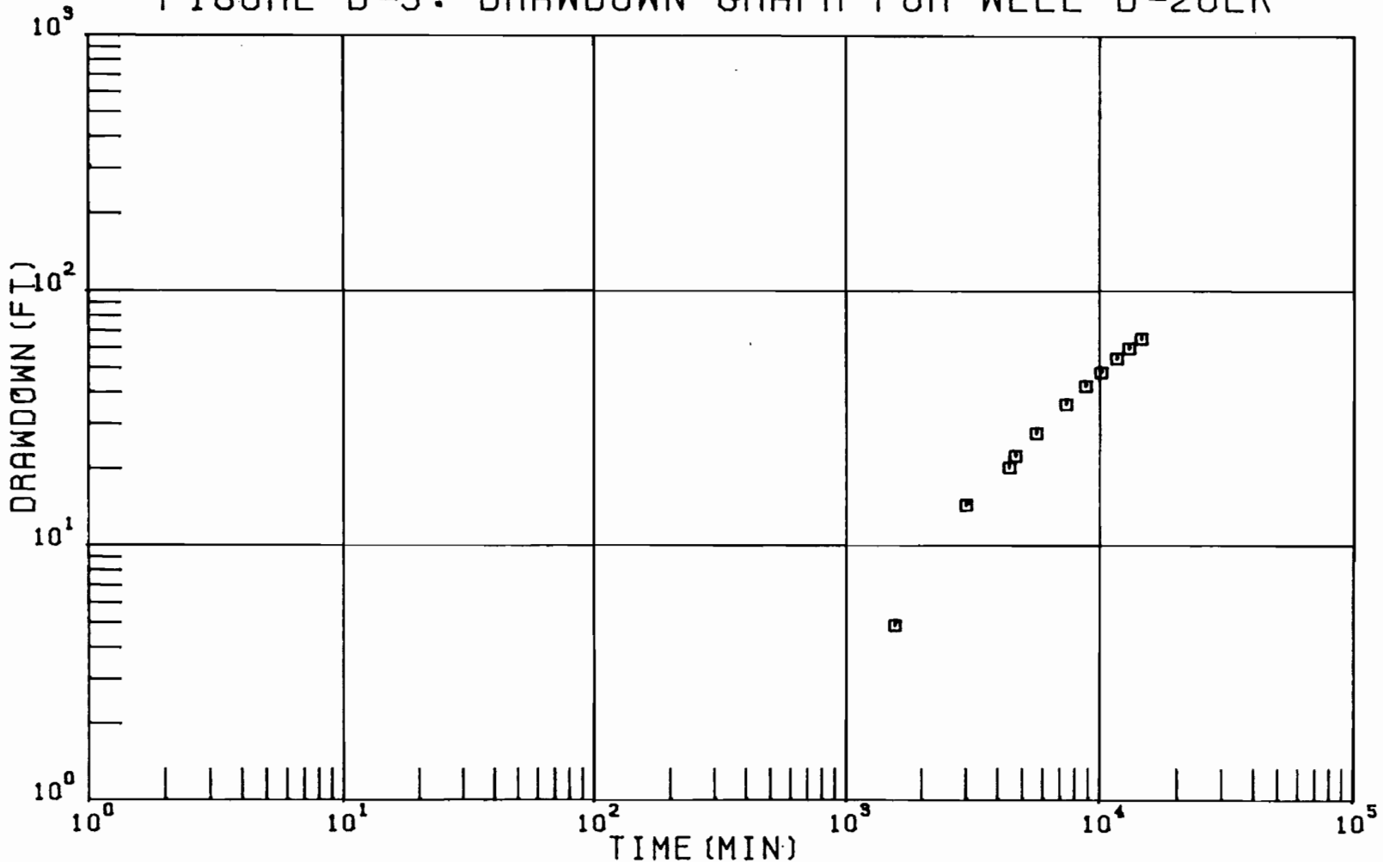

W 20-2 20-1-3-9

APPENDIX C

SEMILOGARITHMIC TIME-RESIDUAL DRAWDOWN GRAPHS

FIGURE C-1: RECOVERY GRAPH FOR WELL D-PW

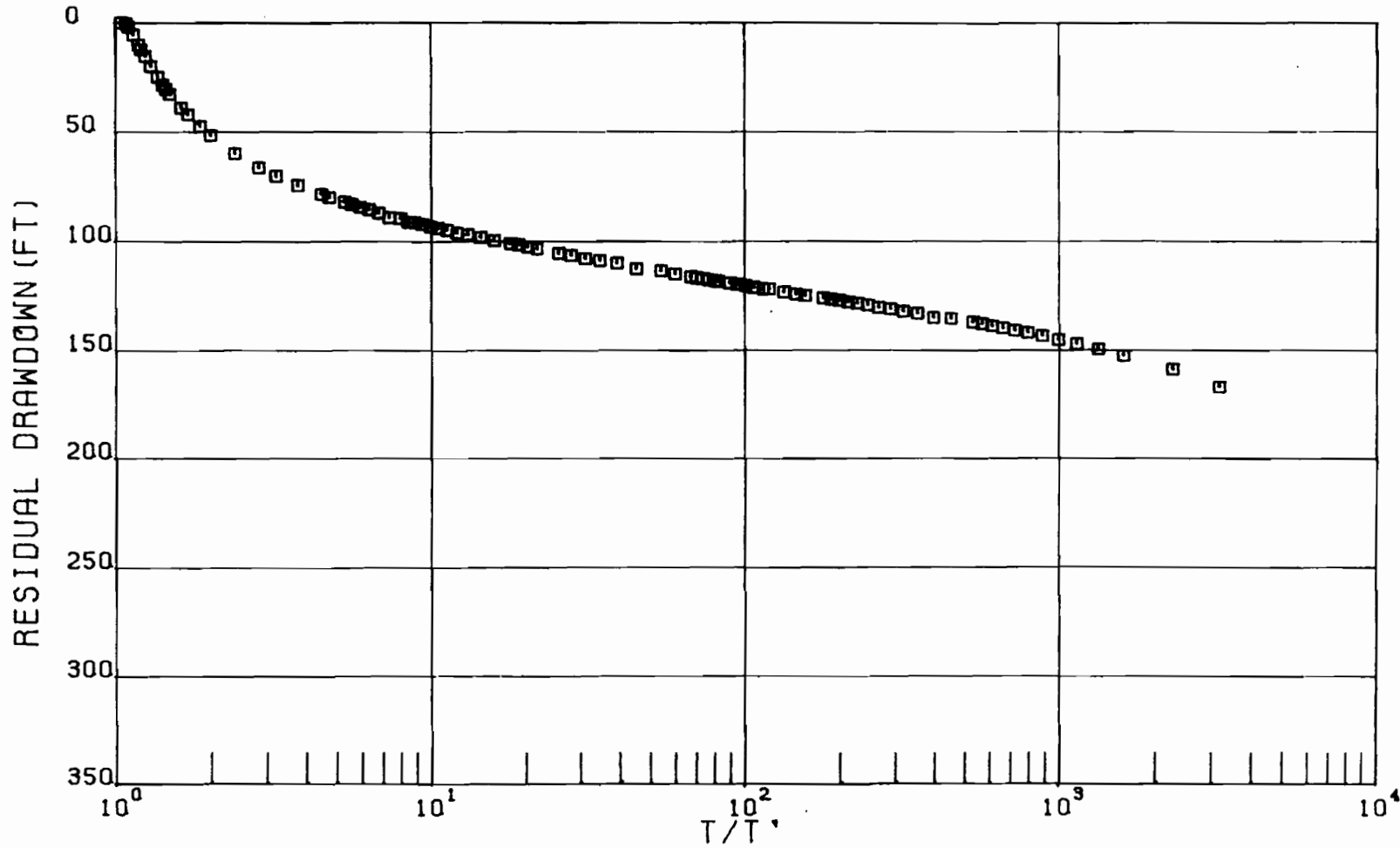
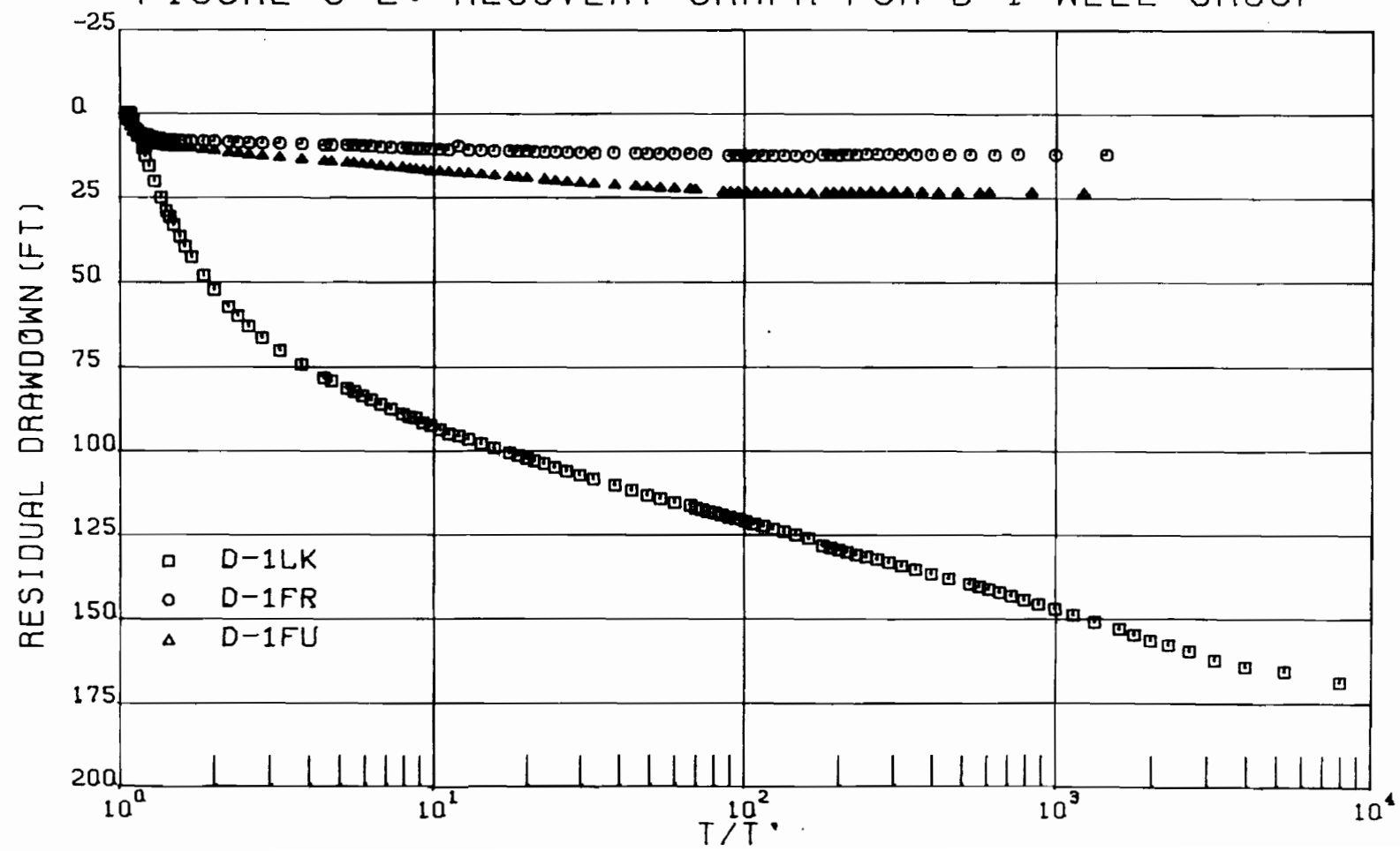

FIGURE C-2: RECOVERY GRAPH FOR D-1 WELL GROUP



WR28-2-520-128.C-2

Dewey-Burdock GDP
June 2012

3.7-B-857

Appendix 3.7-B

FIGURE C-3: RECOVERY GRAPH FOR WELL D-2LK

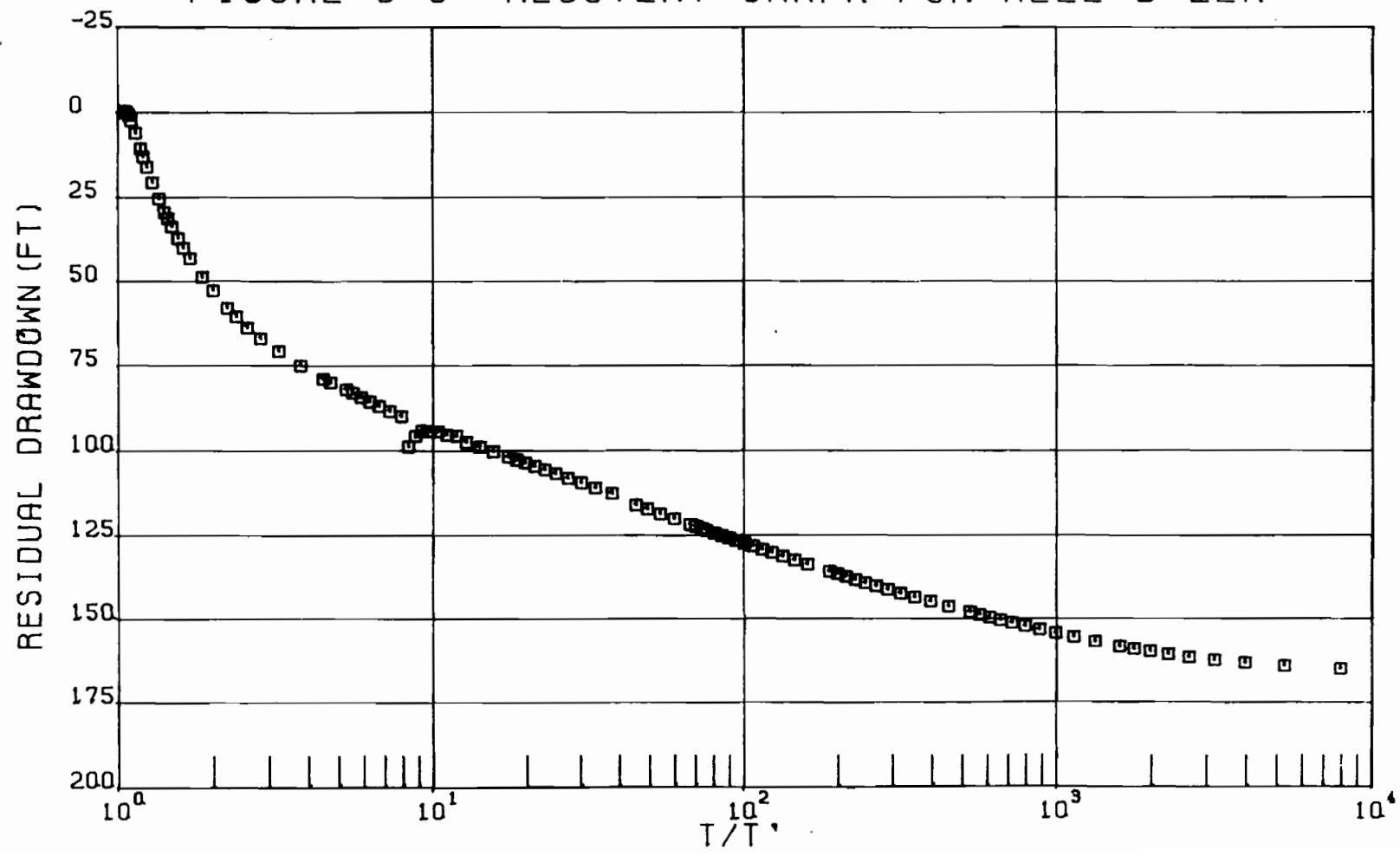

M...J-2 020-120.0-3

Dewey-Burdock GDP
June 2012

3.7-B-858

Appendix 3.7-B

FIGURE C-4: RECOVERY GRAPH FOR D-3 WELL GROUP

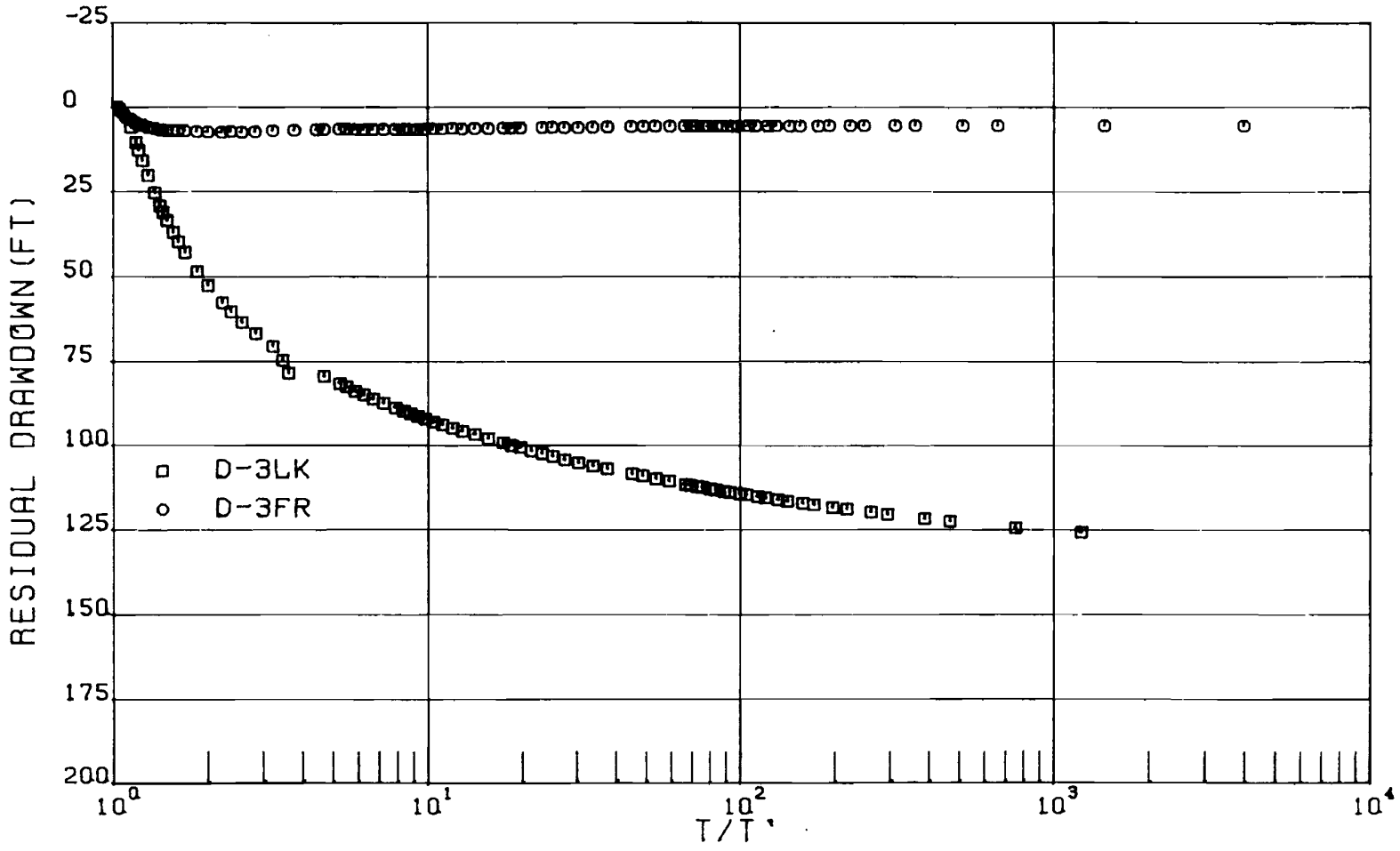

WR20-2-020-128.C-4

Dewey-Burdock GDP
June 2012

3.7-B-859

Appendix 3.7-B

FIGURE C-5: RECOVERY GRAPH FOR D-4 WELL GROUP

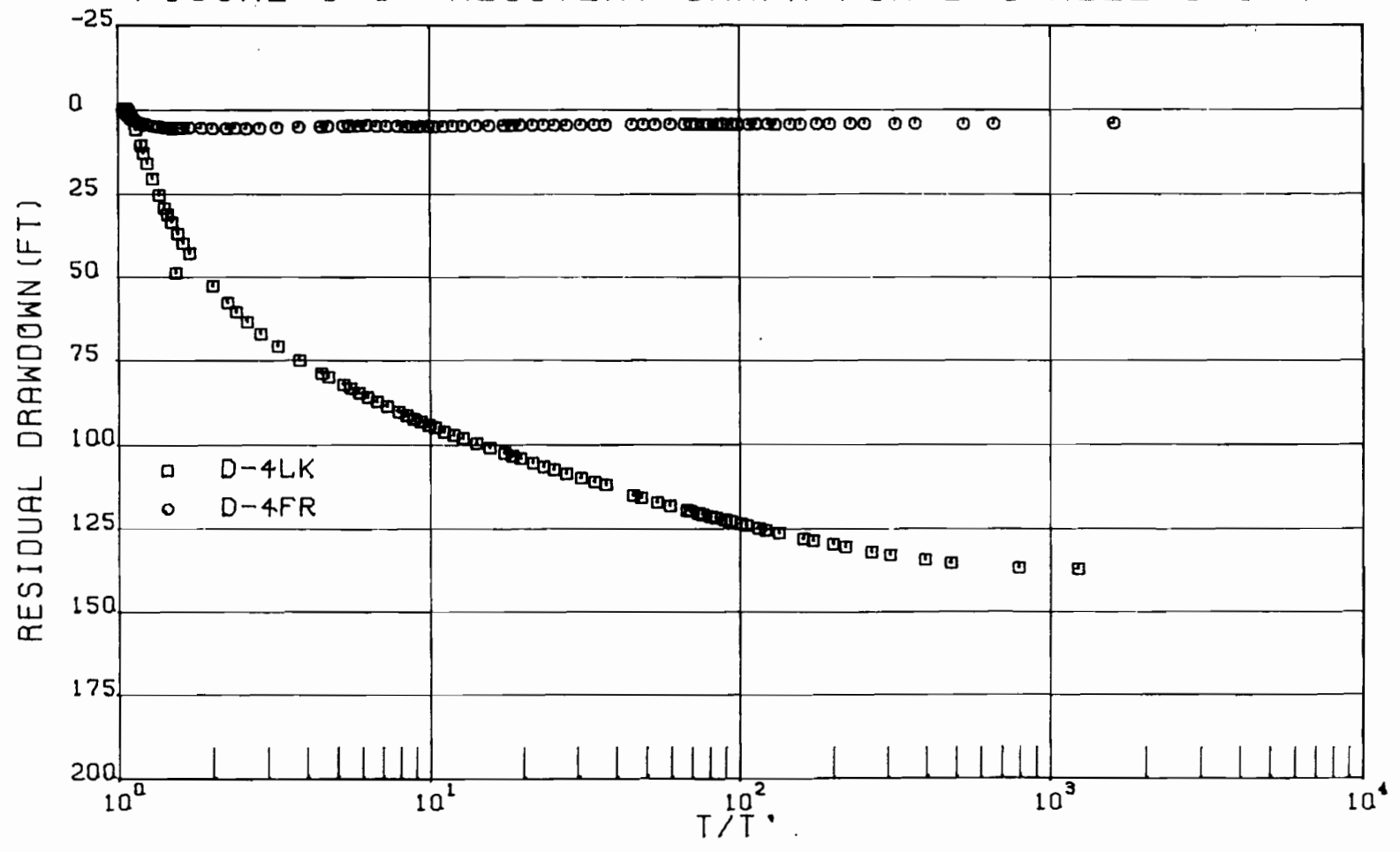

wn28-4-320-128.C-5

FIGURE C-6: RECOVERY GRAPH FOR WELL D-5LK

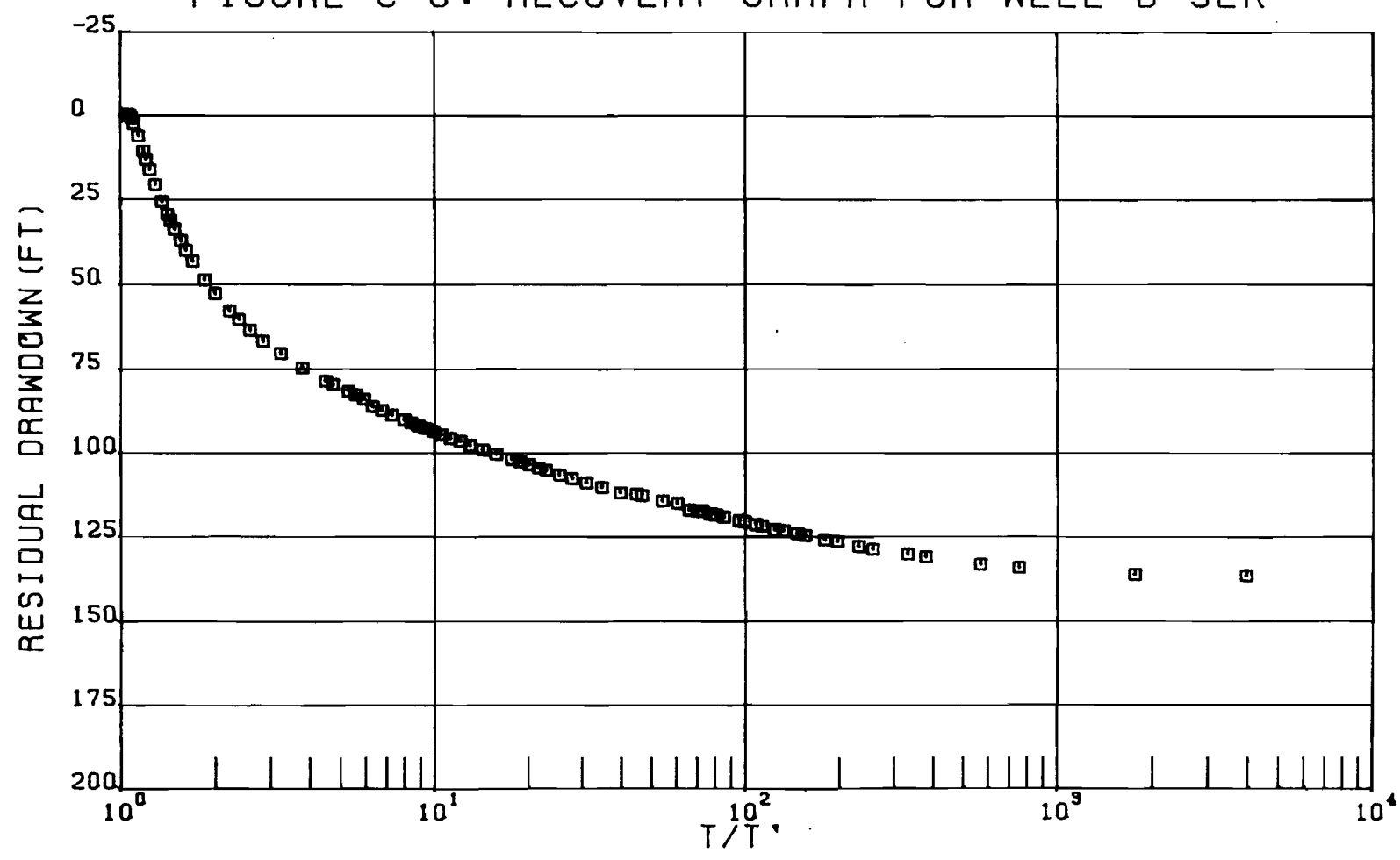

Wncd-520-128.C-6

Dewey-Burdock GDP
June 2012

3.7-B-861

Appendix 3.7-B

FIGURE C-7: RECOVERY GRAPH FOR WELL D-6LK

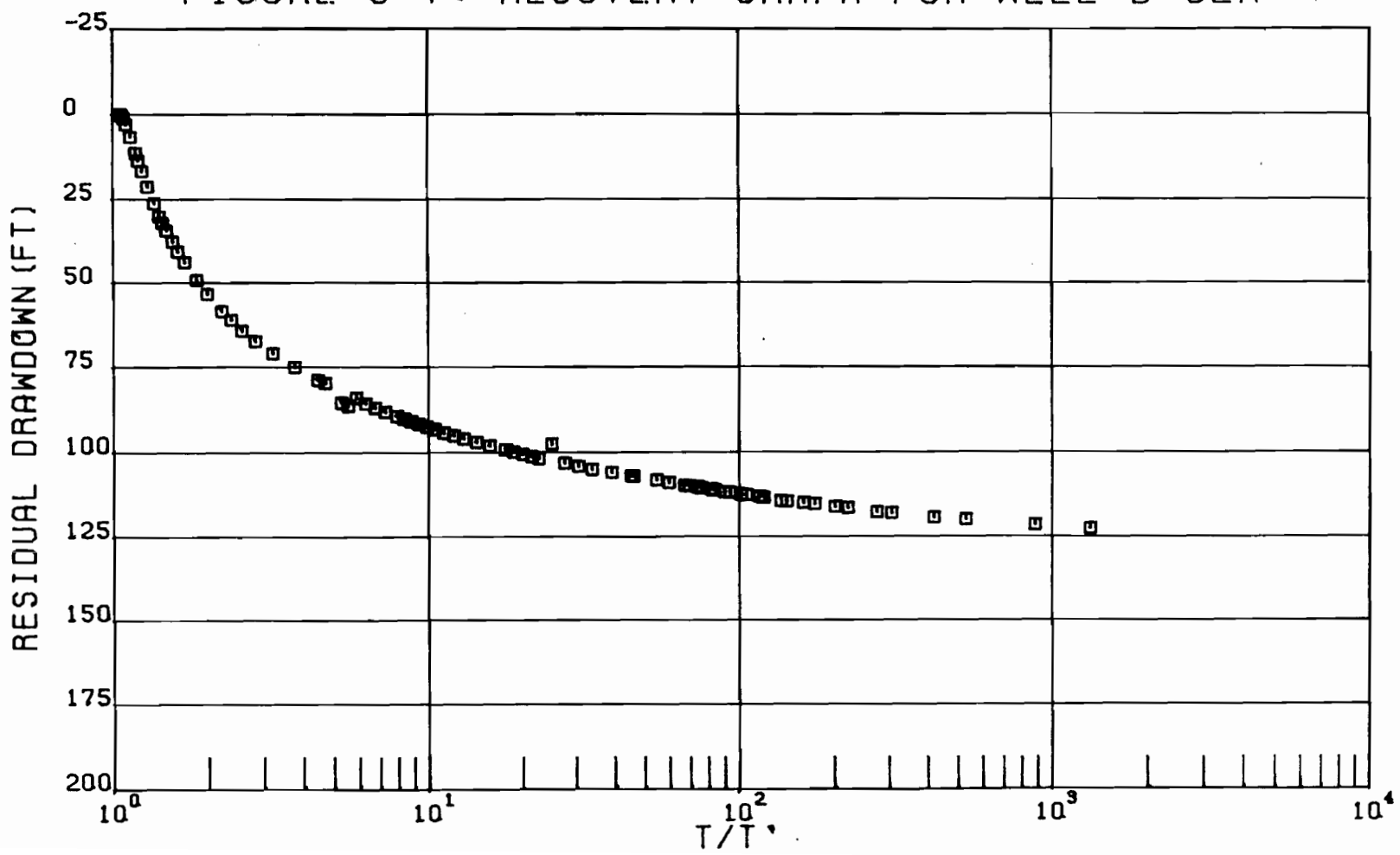

1...8-...126... 7



FIGURE C-9: RECOVERY GRAPH FOR WELL D-20LK

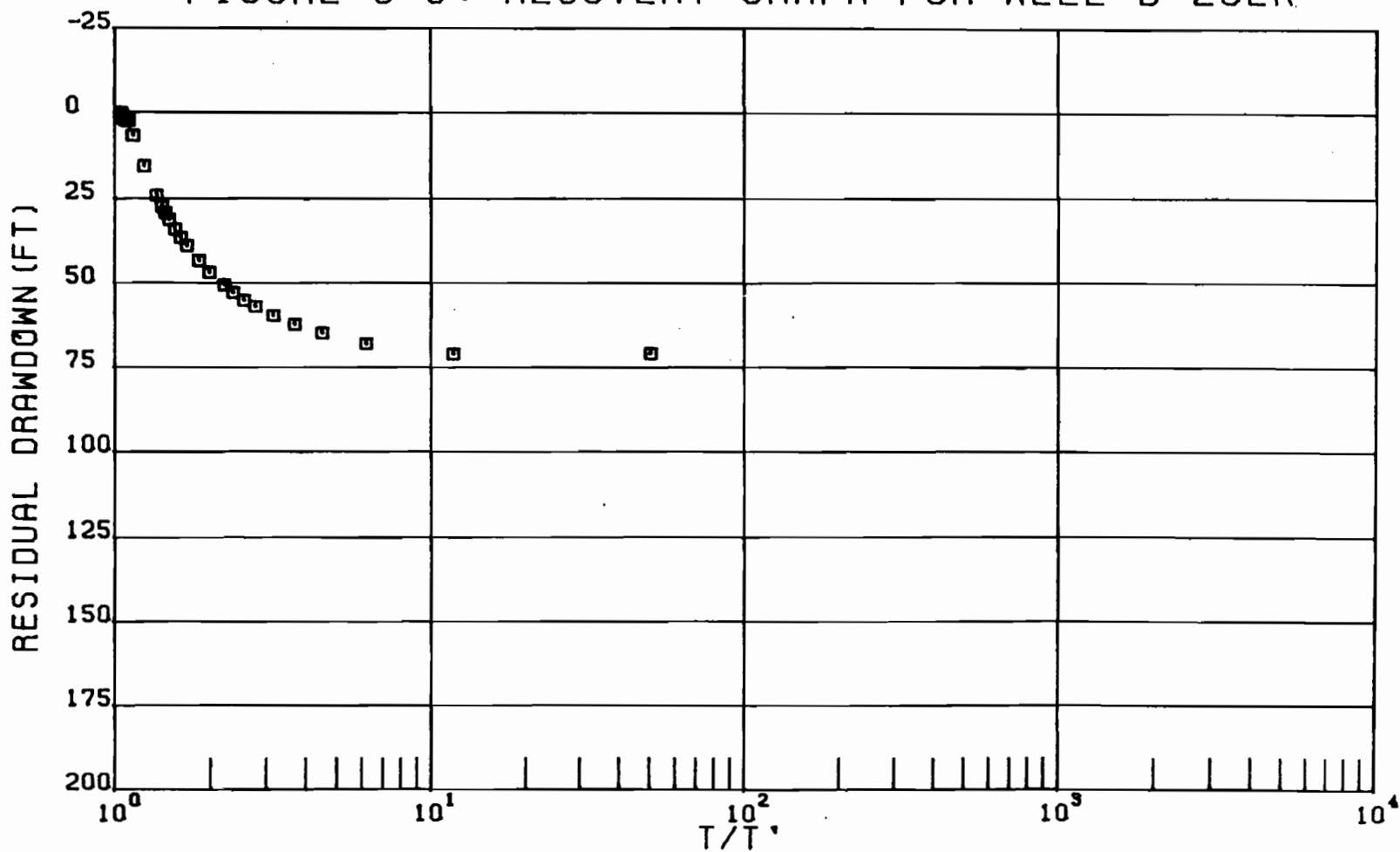

R28-2-520-128.C-9

This page intentionally left blank

SOURCE L

COORDINATES, ELEVATIONS AND WATER LEVELS FOR BURDOCK PIEZOMETERS

(Letter from Keith Andersen, Silver King Mines, Inc., to John Hatch, South Dakota Water Rights
Commission, January 12, 1979)

This page intentionally left blank

Coordinates (SKM Grid) and Elevations for Burdock Area Observation Wells

Well	Aquifer	Coordinates	Measuring Point Elevation	Height of Measuring Point Above Ground Level	
Original Nine Wells Installed Fall 1976 (Abandoned five Fall 1978)					
B-1	FR 672	Kf	90,856 E 188,869 N	3622.07	- 1.0 ft.
B-2	Aban	K ₁	90,808 E 188,859 N	3621.08	0
B-3	FR ?	Kf	93,532 E 190,992 N	3701.16	2.0 ft.
B-3	Aban	K ₁	93,583 E 191,005 N	3701.63	1.6 ft.
B-4	Aban	K ₁	95,531 E 190,551 N	3679.45	2.58 ft.
B-5	637 Aban	K ₁	97,944 E 191,909 N	3731.04	1.9 ft.
B-6	FR 659	Kf	91,925 E 192,493 N	3642.64	0
B-6	660 Aban	K ₁	91,874 E 192,472 N	3644.12	0
B-8	661	K ₁	100,952 E 193,839 N	3788.58	2.0 ft.
Burdock Well	Kf, K ₁ 668	Kf, K ₁	91,081 E 189,167 N	3624.16	= GL Elevation
Four Additional Wells Installed August 1977					
B-7	FR 665	Kf	93,303 E 190,402 N	3671.24	1.75 ft.
B-7	666	K ₁	93,279 E 190,373 N	3671.1	2.08 ft.
B-9	FR 646	Kf	91,389 E 187,658 N	3605.42	3.0 ft.
B-9	658	K ₁	91,389 E 187,658 N	3605.42	2.6 ft.
Seven Replacement Wells Installed Fall 1978					
B-2	LAK 674	Kf	90,776 E 188,900 N	3621.11	1.3 ft.
B-2	FU 673	K ₁ f	90,767 E 188,841 N	3619.96	0
B-10	FR 671	Kf	91,221 E 189,275 N	3631.19	1.4 ft.
B-10	FU 670	K ₁ f	91,265 E 189,344 N	3630.31	1.6 ft.
B-10	LAK 669	K ₁	91,206 E 189,317 N	3631.24	1.6 ft.
B-11	FR 664	Kf	90,805 E 189,721 N	3623.94	0
B-11	LAK 663	K ₁	90,843 E 189,739 N	3624.82	1.0 ft.



Revised Coordinates and Elevations for Burdock Piezometers

<u>Well</u>	<u>Coordinates</u>		<u>Measuring Point Elevation</u>	<u>Height of Measuring Point to Ground Level</u>
1-1 FR	90,856.22 E	188,868.81 N	3622.07	-1.0
1-2 LAK	90,775.65 E	188,899.89 N	3621.11	1.3 ft.
1-2 Fuson	90,767.34 E	188,841.37 N	3619.96	0'
1-3 FR	93,531.56 E	190,991.69 N	3701.16	2 ft.
1-4	95,530.98 E	190,550.99 N	3679.45	2.58 ft.
1-6 FR	91,924.72 E	192,492.25 N	3642.64	0'
1-6	91,874.49 E	192,471.83 N	3644.12	0'
1-7	93,279.33 E	190,372.99 N	3671.10	2.08 ft.
1-7 FR	93,303.13 E	190,401.62 N	3671.24	1.75 ft.
1-9	91,388.52 E	187,657.99 N	3605.42	3 ft.
1-10 FR	91,220.54 E	189,274.64	3631.19	1.4 ft.
1-10 LAK	91,205.62	189,317.02	3631.24	1.6 ft.
1-10 Fuson	91,265.09	189,343.85	3630.31	1.6 ft.
1-11 LAK	90,842.73	189,738.78	3624.82	1 ft.
1-11 FR	90,805.19	189,720.73	3623.94	0'
Sundance Well 662	95,840.49 E	189,370.12 N	3647.84	3 ft.
Burdock Well	91,081.12	189,167.42	3624.16 = GL Elevation	

Water Level Measurements for Burdock Piezometers

All pressure measurements on 9-21 are 2-2.75 psi lower than previous measurement - gauge may not have been accurate.

B-1	7-20-78	14.25 psi		
	9-21-78	12.25 psi		
	10-13-78	8.80 psi	Burdock well flowing	
B-2	7-20-78	16.0 psi	Abandoned 11-10-78	
	9-21-78	13.25 psi		
B-3	7-20-78	35.9'		
	8-4-78	36.3'		
	airlifted on 8-4			Abandoned 11-10-78
	8-21-78	36.5		
	9-21-78	36.8		
B-3 FR	7-20-78	37.5		
	8-4-78	37.7		
	airlifted on 8-4			
	8-21-78	37.3		
	9-21-78	37.6		
	10-13-78	38.7	Burdock well flowing	
	11-22-78	38.8		
B-4	7-20-78	11.5'	Water Level in Annulus 11.8'	
	9-21-78	12.1'		
	10-13-78	13.6	Burdock well flowing	
	11-21-78	13.9	Abandoned 12-5-78	



B-5	7-20-78	48.8	Burdock well flowing Abandoned-12-5-78
	9-21-78	49.4	
	10-13-78	49.7	
	11-21-78	50.0	
B-6	7-20-78	10.3 psi	Burdock well flowing Abandoned 12-5-78
	9-21-78	8.25 psi	
	10-13-78	7.75 psi	
B-6 FR	7-20-78	7.75 psi	Burdock well flowing
	9-21-78	5.5 psi	
	10-13-78	5.5 psi	
B-7	7-20-78	8.9'	Airlifted
	7-26-78	9.0'	
	8-4-78	9.3'	Airlifted Airlifted Burdock well flowing
	8-7-78	9.2'	
	8-21-78	9.2'	
	9-21-78	9.3'	
	10-13-78	12.6	
	11-21-78	11.5	
B-7 FR	7-20-78	17.6'	Airlifted
	7-26-78	17.4	
	8-4-78	12.5'	Airlifted Airlifted Burdock well flowing
	8-8-78	12.4'	
	8-21-78	12.3'	
	9-21-78	12.6'	
	10-12-78	13.75	
	11-21-78	15.5	
B-8	7-20-78	96.25'	Airlifted
	8-4-78	97.5'	
	8-21-78	97.3'	
	9-21-78	97.9'	
B-9	7-20-78	19.2 psi	Burdock well flowing
	9-21-78	17.0 psi	
	10-13-78	15.0 psi	
B-9 FR	7-20-78	17.9 psi	Burdock well
	9-21-78	16.0 psi	
	10-13-78	15.25 psi	

Outlying Piezometer Wells

Locations:

BPZ 14 & 15 FR	T8S, R2E, sec 23	NE/4	NW/4	NW/4
BPZ 16 & 17 FR	T7S, R2E, sec 30	SW/4	SE/4	SE/4
BPZ 18 & 19 FR	T40N, R60W, sec 27	SE/4	SE/4	NW/4
BPZ 20 & 21 FR	T6S, R1E, sec 29	SW/4	NW/4	NE/4
BPZ 22 & 23 FR	T41N, R60W, sec 9	SW/4	SE/4	SE/4

BPZ 14 #602
BPZ 15 FR #601
BPZ 16 #643
BPZ 17FR #644
BPZ 18 #608
BPZ 19 FR #607
BPZ 20 #609
BPZ 21 FR #610
BPZ 22 #626
BPZ 23 FR #625



Water Levels:

BPZ 14	7-20-78	130.5'	
	8-7-78	130.2'	Airlifted
	8-22-78	136'	Airlifted
	9-21-78	136.5'	
	10-13-78	136.6	
	11-21-78	135.9	
BPZ-15 FR	7-20-78	59.5'	
	8-7-78	51.5'	Airlifted
	8-9-78	47.7'	
	8-22-78	47.5	Airlifted
	9-21-78	47.7'	Airlifted
	10-13-78	47.8	
	11-21-78	47.5	
BPZ-16	7-20-78	7.0 psi	shut in on this date
	8-9-78		Airlifted
	9-21-78	9.0 psi	
	10-13-78	9.0 psi	
BPZ-17	7-20-78	20.6'	
	8-9-78	20.6'	Airlifted
	8-22-78	21.8'	
	9-21-78	21.9'	
	10-13-78	21.9'	
	11-21-78	22.0'	
BPZ-18	8-7-78	17.5'	
	9-21-78	17.7'	
	10-16-78	17.7	Airlifted
	11-20-78	20.3"	
BPZ-19 FR	8-7-78	21.8'	Airlifted
	8-22-78	18.3'	Airlifted
	9-21-78	18.7'	Airlifted
	10-16-78	21.1	
	11-21-78	19.8	
BPZ-20	7-20-78	4.8'	
	7-31-78	4.75'	Airlifted - much mud
	8-3-78	172.7'	
	8-21-78	83'	Airlifted
	9-20-78	73.3'	Airlifted
	10-12-78	108.5	Airlifted
	11-21-78	89.9	



(Continued-Page 4)

BPZ-21 FR	7-31-78	Slight Flow	Airlifted
	8-3-78	15'	
	8-8-78	11.5'	
	8-21-78	6.3'	Airlifted
	9-20-78	7.5'	Airlifted
	10-12-78	9.3	
	11-21-78	8.7	
BPZ-22	7-20-78	65.9'	
	7-31-78	64.5'	Airlifted - much mud
	8-3-78	153.9'	
	8-21-78	89.3'	Airlifted
	9-20-78	76.1'	Airlifted
	10-12-78	85.1'	Airlifted
	11-21-78	70.5'	
BPZ-23 FR	7-20-78	73.2'	
	7-31-78	70'	Airlifted
	8-3-78	72.7'	
	8-21-78	70.3'	Airlifted
	9-20-78	68.6'	Airlifted
	10-12-78	73.8	
	11-21-78	73.3	

Depth of Screen:

BPZ-14	588-630
BPZ-15 FR	336-378
BPZ-16	252-294
BPZ-17 FR	84-126
BPZ-18	798-882
BPZ-19 FR	672-714
BPZ-20	903-966
BPZ-21FR	630-672
BPZ-22	588-630
BPZ-23 FR	420-462

attempted to set 42' dcd

not pressure grouted

BPZ 14 #602
BPZ 15 FR #601
BPZ 16 #643
BPZ 17FR #644
BPZ 18 #608
BPZ 19 FR #607
BPZ 20 #609
BPZ 21 FR #610
BPZ 22 #626
BPZ 23 FR #625

All wells constructed of 1" blk iron pipe with torch slot screen. Grout pumped down annulus to desired depth with 1" plastic pipe.

This page intentionally left blank

SOURCE M

CONSTRUCTION AND LOCATION DATA FOR DEWEY PUMP TEST WELLS

(in letter from Keith Andersen, Silver King Mines, Inc., to Steve Stampfli, Office of Surface Mining, South Dakota Department of Water and Natural Resources, March 3, 1982)

This page intentionally left blank

WELL #	611 DEWEY TEST WELL	613 D-1 FR	614 D-1 Fu	615 D-1 LK	612 D-2 LK	436 D-3 FR	657 D-3 LK	623 D-4 FR	622 D-4 LK	616 D-5 LK	617 D-6 LK	624 D-7 FR
Hole Number	DWT-99	DWM-51	54	46	47	49	48	52	50	55	56	DXM-1
Date Drilled	10-17-81	7-21-81	9-04-81	7-07-81	7-09-81	7-16-81	7-14-81	7-23-81	7-20-81	9-09-81	9-11-81	7-30-81
Date Completed	10-17-81	8-14-81	9-14-81	8-13-81	8-14-81	8-18-81	8-18-81	8-17-81	8-17-81	9-15-81	9-15-81	7-30-81
Depth Cased	694	504	609	712	692	505	715	503	714	735	715	120
Depth Completed	801	580	620	800	800	590	800	580	780	835	810	120
X-Coord.	80798	80923	80982	80972	80710	80385	80416	81564	81618	81126	80004	76979
Y-Coord.	214898	215036	215035	214972	215068	215595	215658	215330	215281	214090	214495	219008
Collar Elev.	3736.2	3737.3	3741.1	3741.4	3728.5	3738.0	3744.3	3753.5	3751.4	3747.7	3723.3	3723.9
"r"		175.0	211.7	190.1	191.9	175.0	150.0	190.7	160.0	170.0	190.0	175.0
SWL (12-3-81)	34.16	26.23	32.16	39.68	26.56	21.03	42.37	34.22	49.68	45.86	21.42	Surface

Source: Letter from Keith Andersen, Silver King Mines, Inc., to Steve Stampfli, Office of Surface Mining, South Dakota Department of Water and Natural Resources, March 3, 1982

This page intentionally left blank

SOURCE N

BURDOCK MINE AREA HYDROLOGY STATUS REPORT

(Silver King Mines, Inc. Interoffice Correspondence from Keith Andersen to R.M. Caywood, December 18, 1978, provided in a letter from Keith Andersen to John Hatch, South Dakota Water Rights Commission, January 12, 1979)

This page intentionally left blank



POWERTECH (USA) INC.

INTEROFFICE CORRESPONDENCE

Company Silver King Mines, Inc. Date December 18, 1978

To: R. M. Caywood

From: Keith E. Andersen

Subject: Burdock Mine Area Hydrology
Status Report

Uranium ore in economically recoverable quantities has been discovered northwest of Edgemont, South Dakota, near Burdock on lands leased by the Tennessee Valley Authority. The ore is located in the Lakota Formation. Tentative plans call for conventional underground mining techniques which will require dewatering the ore zone during the mining operation. The Lakota Formation and the overlying Fall River Formation are the two principal aquifers supplying domestic water for area ranches. In view of this information, it was apparent that extensive hydrologic investigations would be required in planning the proposed mine.

An attempt has been made to identify all wells and springs having their source in the Fall River or Lakota Formation within approximately a 25 mile radius of the proposed mine. Appended are lists of these wells. The list entitled "Water Wells in the Edgemont Project Area" includes those wells felt most likely to be affected by proposed mine dewatering because of their proximity to the mine and their topographic location along the Cheyenne River Basin. Information on these wells was obtained from personal visits to the wells and with the well owners, Silver King Mines, Inc. files, South Dakota Geological Survey Report #109 "Ground Water Resources of the Western Half of Fall River County, SD" by Jack Keene, and from USGS Hydrologic Atlas "Water Resources of the Powder River Basin and Adjacent Areas, Northeastern Wyoming" by Hadson, Pearl, and Druse. Since completion of this listing in May, 1977, selected wells from this list have been monitored on a quarterly basis. Information on other wells within 25 miles of the proposed mine is as shown on the listings.

In addition to monitoring selected existing wells several observation wells have been installed to monitor water levels in the Fall River and Lakota aquifers. Initially nine observation wells were constructed in the Burdock area during the fall of 1976 to monitor water level drawdown during the February, 1977, pump test. Four more wells were installed during August, 1977, to provide additional information for the November, 1977, pump test. To provide additional information on area water levels ten wells were installed during the summer of 1978 at selected locations throughout the project area. Finally, when it appeared that some of the original nine wells were not providing reliable data, five of these wells were cemented off and abandoned and seven replacement wells drilled during the fall of 1978. Information on all of the observation wells is appended.

P. 300 B 4M 7.88



R. M. Caywood
Keith E. Andersen

Page 2

A test well was constructed during January, 1977, for the purpose of conducting pump tests and potentially for dewatering use. This well was pumped during the February, 1977, and November, 1977, pump tests.

The well was allowed to free flow after completion until February 11, 1977, the starting date for the first pump test. This flow resulted in pre-pump test drawdown as shown in the attached data. The well was pumped from both aquifers for 337 hours at an average discharge of 261 gpm. The water level in the well stabilized at 433 feet of drawdown after 280 hours. Data from observation well B-2 indicated the static head on the well before it was allowed to flow was about +30 feet. Using a total drawdown of 463 feet the specific capacity of the well was estimated at 0.56 gpm/ft..

Coefficients of transmissibility and storage were estimated from the observation well drawdown data using the time-drawdown graphical solution to the Theis non-equilibrium well formula. It was necessary to estimate the pumping rate from the Fall River and Lakota for this analysis. The Fall River pumping rate was estimated at 100 gpm and the Lakota at 161 gpm. Using these figures, the transmissivity and storage coefficient of the Lakota were estimated at 1600 gpd/ft. and 5.5×10^{-5} , respectively, and at 860 gpd/ft. and 4×10^{-5} for the Fall River.

Since approximately one-half of the domestic wells in the area produce from the Fall River aquifer and since it would be possible to sink a shaft through the Fall River with minimal disturbance to water levels, another pump test was planned to determine if the Fall River and Lakota were hydraulically connected. Four additional observation wells were installed in preparation for this test.

Following the February, 1977, pump test the well was shut in and not allowed to flow at the surface. Water was able to communicate between the aquifers since the well screen was open to both aquifers. During the week of October 25, 1977, the Fall River aquifer was isolated and shut in with a pneumatic packer. The Lakota was allowed to free flow until the pump test, November 14, again resulted in pre-pump test drawdown.

The pump test began at 10:00 a.m. on November 14, and continued until November 17. By the morning of November 17, it appeared that sufficient data had been obtained to determine whether or not leaky aquifer conditions existed in the Burdock area and the initial phase of the test was terminated at 11:30 a.m.. The average pumping rate for this period was 193 gpm. Assuming that the water levels in piezometers B-1 FR and B-2 were the same as the Fall River and Lakota water levels in the well before the pump was installed, the total Lakota drawdown at the end of the initial phase was 267 feet and the total Fall River drawdown was 49 feet. At 11:30 a.m. the pumping rate was increased to 225 gpm in an attempt to provide additional data on the apparent specific capacity of the well and on the rate of drawdown in the Fall River with respect to the head differential between the Fall River and Lakota water levels.



R. M. Caywood

Keith E. Anderson

Page 3

After two hours additional pumping at 225 gpm the Lakota drawdown was 298 feet and the Fall River drawdown was 50 feet. At 1:30 p.m. the pumping rate was increased to 250 gpm. For the next hour the pumping rate fluctuated considerably because the pipeline from the well head to the holding reservoir was not capable of handling the increased flow. The pipeline broke and was repaired several times causing a varying pumping head and varying pumping rate. The pumping rate was cut back to 230 gpm at 3:00 p.m.. The pneumatic packer, which had been set at 200 psi, was pressured to 250 psi at 3:15 p.m. to see what effect this might have on the rate of drawdown in the Fall River. The pump was shutoff at 4:15 p.m. and water level recovery rates monitored.

~~Time-drawdown data from this pump test indicated a complex hydrologic system~~ in this area, with the effects of both leakage and boundary conditions influencing ground water flow. Early time data indicated a transmissivity of about 1600 gpd/ft. and storage coefficient of about 7.5×10^{-5} for the Lakota, which agreed reasonably well with the values calculated for the first test. Attempts at more detailed analysis of the data were not successful.

Because of the difficulty in analyzing the drawdown data it began to appear that some of the data might be unreliable. To investigate this possibility, cement logs were run on wells B-2, B-3, B-4, and B-5. These logs showed the cement grout was not properly placed to isolate the Fall River and Lakota in these wells. These four wells and well B-6 have been abandoned and replaced with seven new wells. Sonic bond logs were run on the new wells, which showed the wells to be properly grouted.

At this time two additional pump tests are planned in the Burdock Area to obtain more reliable hydrologic data on the Lakota and Fall River aquifers. A three-five day test pumping from the Lakota is tentatively scheduled for early January, 1979, followed by a three-five day test pumping from the Fall River.

Keith E. Anderson

Keith E. Andersen, Chief Engineer

This page intentionally left blank

SOURCE O

ANALYSIS OF AQUIFER TESTS CONDUCTED AT THE PROPOSED BURDOCK URANIUM MINE SITE, BURDOCK,
SOUTH DAKOTA

(Report No. WR28-1-520-109, J. M. Boggs and A.M. Jenkins, Tennessee Valley Authority, May 1980)

This page intentionally left blank



POWERTECH (USA) INC.

KEITH ANDERSON

WR28-1-520-109

**ANALYSIS OF AQUIFER TESTS CONDUCTED
AT THE PROPOSED BURDOCK URANIUM MINE SITE
BURDOCK, SOUTH DAKOTA**

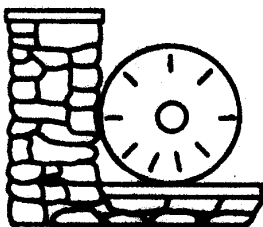

TENNESSEE VALLEY AUTHORITY
OFFICE OF NATURAL RESOURCES
DIVISION OF WATER RESOURCES
WATER SYSTEMS DEVELOPMENT BRANCH
NORRIS, TENNESSEE



Tennessee Valley Authority
Office of Natural Resources
Division of Water Resources
Water Systems Development Branch

ANALYSIS OF AQUIFER TESTS CONDUCTED
AT THE PROPOSED BURDOCK URANIUM MINE SITE
BURDOCK, SOUTH DAKOTA

Report No. WR28-1-520-109

Prepared by
J. M. Boggs
and
A. M. Jenkins

Norris, Tennessee
May 1980

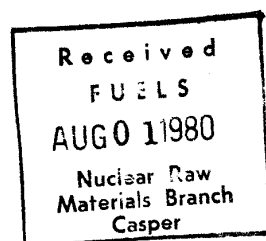



CONTENTS

	Page
Abstract	i
Introduction	1
Hydrogeology	3
Regional Setting	3
Aquifers	3
Aquifer Test Design	7
Lakota Aquifer Test	11
Test Procedures and Result	11
Interpretation of Test Results	15
Fall River Aquifer Test	18
Test Procedures and Results	18
Interpretation of Test Results	21
Fuson Aquitard Properties	23
Computer Model Simulations	27
Summary and Conclusions	31
References	33
Appendix	34

LIST OF FIGURES

<u>No.</u>	<u>Title</u>	<u>Page</u>
1	Generalized Geologic Map of Site Region	35
2	Burdock Well Profile	36
3	Well Location Map	37
4	Hydrographs for Burdock Test Well, January 1 Through April 17, 1979	38
5	Hydrographs for B-10 Observation Well Group, January 1 Through April 17, 1979	39
6	Pre-test Ground-water Level Contours for the Lakota Aquifer	40
7	Semilogarithmic Graph of Drawdown for the Pumped Well, Lakota Aquifer Test	41
8	Semilogarithmic Graphs of Drawdown for B-10 Observation Well Group, Lakota Aquifer Test	42
9	Semilogarithmic Graphs of Drawdown for B-1 Observation Well Group, Lakota Aquifer Test	43
10	Seimlogarithmic Graphs of Drawdown for B-11 Observation Well Group, Lakota Aquifer Test	44
11	Semilogarithmic Graphs of Drawdown for B-9 Observation Well Group, Lakota Aquifer Test	45
12	Semilogarithmic Graphs of Drawdown for B-7 Observation Well Group, Lakota Aquifer Test	46
13	Logarithmic Graphs of Drawdown for B-10 Observation Well Group, Lakota Aquifer Test	47~
14	Logarithmic Graphs of Drawdown for B-1 Observation Well Group, Lakota Aquifer Test	48
15	Logarithmic Graphs of Drawdown for B-11 Observation Well Group, Lakota Aquifer Test	49
16	Logarithmic Graphs of Drawdown for B-9 Observation Well Group, Lakota Aquifer Test	50
17	Logarithmic Graphs of Drawdown for B-7 Observation Well Group, Lakota Aquifer Test	51



LIST OF FIGURES (continued)

<u>No.</u>	<u>Title</u>	<u>Page</u>
18	Drawdown Versus Distance from the Pumped Well, Lakota Aquifer Test	52
19	Drawdown in Lakota Aquifer at End of Lakota Test	53
20	Drawdown in Fall River Aquifer at End of Lakota Test	54
21	Recovery Graphs for B-10 Observation Well Group, Lakota Aquifer Test	55
22	Recovery Graphs for B-1 Observation Well Group, Lakota Aquifer Test	56
23	Recovery Graphs for B-11 Observation Well Group, Lakota Aquifer Test	57
24	Recovery Graphs for B-9 Observation Well Group, Lakota Aquifer Test	58
25	Recovery Graphs for B-7 Observation Well Group, Lakota Aquifer Test	59
26	Semilogarithmic Graph of Drawdown for the Pumped Well, Fall River Aquifer Test	60
27	Semilogarithmic Graphs of Drawdown for B-10 Observation Well Group, Fall River Aquifer Test	61
28	Semilogarithmic Graphs of Drawdown for B-1 Observation Well Group, Fall River Aquifer Test	62
29	Semilogarithmic Graphs of Drawdown for B-11 Observation Well Group, Fall River Aquifer Test	63
30	Logarithmic Graphs of Drawdown for the Pumped Well, Fall River Aquifer Test	64
31	Logarithmic Graphs of Drawdown for B-10 Observation Well Group, Fall River Aquifer Test	65
32	Logarithmic Graphs of Drawdown for B-1 Observation Well Group, Fall River Aquifer Test	66



LIST OF FIGURES (continued)

<u>No.</u>	<u>Title</u>	<u>Page</u>
33	Logarithmic Graphs of Drawdown for B-11 Observation Well Group, Fall River Aquifer Test . . .	67
34	Recovery Graph for the Pumped Well, Fall River Aquifer Test	68
35	Recovery Graphs for B-10 Observation Well Group, Fall River Aquifer Test	69
36	Recovery Graphs for B-1 Observation Well Group, Fall River Aquifer Test	70
37	Recovery Graphs for B-11 Observation Well Group, Fall River Aquifer Test	71
38	Results of Initial Lakota Aquifer Test Simulation . .	72
39	Results of Final Lakota Aquifer Test Simulation . .	73



LIST OF TABLES

<u>No.</u>	<u>Title</u>	<u>Page</u>
1	Generalized Stratigraphic Column for Site Region	4
2	Observation Well Construction Details	8
3	Lakota Aquifer Properties	13
4	Fall River Aquifer Properties	20
5	Fuson Aquitard Properties	25
6	Parameters Used in Computer Simulations	28



ABSTRACT

Separate aquifer tests were conducted in two aquifers which may be affected by TVA's proposed uranium mining operation near Burdock, South Dakota. In April 1979, a constant-discharge test was conducted in the Chilson member of the Lakota formation which comprises the principal ore body and an aquifer of regional importance. The hydraulic properties of both the Lakota (Chilson) aquifer and the overlying Fuson shale aquitard were determined. A second test was conducted in July 1979 in the Fall River aquifer which overlies the Fuson. The hydraulic characteristics of the Fall River aquifer and a second estimate of the Fuson aquitard properties were obtained from the test. The test results indicate that the two aquifers are hydrologically connected via (1) general leakage through the Fuson shale, and (2) direct pathways, probably in the form of numerous old (pre-TVA) unplugged exploration boreholes.

The hydraulic properties of the Fall River, Fuson and Lakota units obtained from the aquifer test analyses were incorporated into a computer model of the site geohydrologic system. These parameters were refined in a calibration process until the model could reproduce the drawdown responses observed during the Lakota aquifer test. Results indicate the transmissivity and storativity of the Lakota (Chilson) aquifer are approximately 1400 gallons per day per foot (gpd/ft) and 1.0×10^{-4} , respectively. The Fall River aquifer has an estimated transmissivity of 400 gpd/ft and a storativity of about 1.4×10^{-5} . The hydraulic conductivity of the Fuson aquitard is estimated at approximately 10^{-3} foot per day. The specific storativity of the Fuson was not measured but is assumed to be about 10^{-6} feet⁻¹.



INTRODUCTION

This report describes the aquifer testing program conducted at the proposed uranium mine site in Burdock, South Dakota. The purpose of the program was to determine the hydrogeologic conditions in the mining area in order to predict mine dewatering requirements and impacts.

The Fall River formation and the Chilson member of the Lakota formation comprise the principal aquifers in the vicinity of the proposed mine. These aquifers are separated by the Fuson shale member of the Lakota formation which acts as an aquitard. The uranium deposits to be mined lie within the Chilson unit.

Two unsuccessful aquifer tests were conducted at the site prior to those described in this report. The first test was conducted at the Burdock test well in February 1977. Pumping took place from both the Fall River and Lakota aquifers during the 14-day test. The test results were invalidated by questionable well discharge measurements and by mechanical difficulties with a deep-well current meter used to measure the quantity of water pumped from each aquifer. A second test lasting three days was performed in November 1977. Pumping was restricted to the Lakota aquifer during the test in order to determine the potential for leakage through the Fuson shale from the overlying Fall River aquifer. The results of the test were inconclusive because (1) five observation wells used in the test were subsequently found to be improperly constructed and (2) pressure gauges used to monitor pumping response at several wells malfunctioned during the test.



The problems associated with the two earlier tests were corrected for the tests described in this report. The defective observation wells were pressure sealed with cement grout and replaced with properly constructed wells. More reliable instrumentation for monitoring potentiometric heads in observation wells was used in subsequent tests.



HYDROGEOLOGY

Regional Setting

The proposed mine site is located in the northwestern corner of Fall River County, South Dakota, less than one mile southeast of the community of Burdock. Geologically, the site is situated on the southwest flank of the Black Hills Uplift (see Appendix, Figure 1). The stratigraphy of the region consists of a sequence of rocks ranging in age from Precambrian to Recent which crop out peripherally to the Black Hills. The Precambrian rocks crop out near the center of the Black Hills, and progressively younger rocks crop out to the southwest. Surficial rocks in the site area range in age from lower Cretaceous to Recent. A generalized stratigraphic column for the site is shown in Table 1.

The major structural features of the region are the southwesterly-trending Dewey and Long Mountain structural zones. Faults, fractures and breccia pipes in these zones are believed to affect the ground-water regime.

Aquifers

The principal aquifers in the region are the alluvial deposits associated with the Cheyenne River and its major tributaries, the Fall River formation, the Lakota formation, the Sundance formation, and the Pahasapa (or Madison) formation. Except for the alluvium, these aquifers crop out peripherally to the Black Hills where they receive recharge from precipitation. Ground-water movement is in the direction of dip, radially from the central Black Hills. In most instances, ground water in these aquifers is under artesian conditions away from the

**TABLE 1: GENERALIZED STRATIGRAPHIC COLUMN FOR BITE REGION
(FROM KEENE, 1973)**

PERIOD	FORMATION NAME	SYM-BOL	COLUMN	LITHOLOGIC DESCRIPTION	THKNS. IN FEET	HYDROLOGIC CHARACTERISTICS
Quaternary	Alluvium	Qal		Gravel, sand, and silt floodplain deposits. Alluvial terraces and windblown material.	1-30	Good to excellent aquifer along floodplains; terraces generally non-productive except for scattered springs.
	Pierre Fm.	Kp		Dark gray shale, weathering brown or buff and containing many fossiliferous concretions.	1000+	Relatively no value as an aquifer; locally large diameter wells in stream valleys may yield small amounts of highly mineralized water during wet seasons.
Cretaceous	Niobrara Fm.	Kn		Black fissile shale, cone-in-cone concretions.	100-225	No known wells.
	Turner sand	Kcr		Gray calcareous shale, weathering yellow and impure chalk with <i>Ostrea Congesta</i> .	520-540	Relatively impermeable; possible small yields from Turner and Wall Creek sands.
	Wall Creek sand			Light gray shale with large concretions.		
	Greenhorn Lms.	Kg		Thin bedded hard limestone, weathering creamy white, contains <i>Inoceramus labatus</i> .	50	Too thin and dense to be an aquifer.
	Belle Fourche Fm.	Kgs		Light gray shale, bentonite, large concretions.	870	Newcastle sand may yield water, permeability is variable.
	Mowry Shale			Light gray siliceous shale.		
	Graneros Group Newcastle sand			Thin brown-to-yellow sandstone.		
	Skull Creek Shale			Black shale		
	Fall River Fm.	Kfr		Interbedded red-brown massive sandstone and Carbonaceous shales.	30-165	Largest producer in the area. Yields up to 60 gpm of highly mineralized water (flow). Water quality generally poor, sometimes yields hydrogen sulfide.
	Fuson Shale	Kik		Gray-to-purple shale, thin shales.	0-180	Relatively good aquifer from the lower Chisnon member, up to 30 gpm artesian flow
Lakota Fm.	Light gray massive limestone.			0-25		
				Coarse, hard, cross-bedded sandstone, buff-to-gray, coal beds locally near base.	130-230	
	Morrison Fm.	Km		Green-to-maraon shale, thin sandstone.	0-125	No known wells, possible aquifer.
Jurassic	Unkpapa Fm.	Ju		Fine grained, massive, vari-colored sandstone.	0-240	No known wells, possible aquifer
	Sundance Fm.	Jsd		Alternating beds of red sandstone and red-to-green marine shales.	250-450	Produces small amounts of water from the sands suitable for domestic use.
Triassic	Speartfish Fm.	Rs		Red silty shale, limestone, and anhydrite near the top. Redbeds. Gypsum locally near the base.	400	Poor producer, small yields of sulfate water
?	Minnekahta Lms.	Cmk		Pale brown, to gray dense, crystalline limestone.	50	Locally secondary fracture porosity
Permian	Opeche Fm.	Co		Red thinly bedded sandstones and shales, purple shale near top.	100	No known wells
?				Converse sand, red-to-yellow cross bedded sand. Red marker, thin red shale near middle. Lea sands, series of thin limestones. Dolomite at bottom with basal laterite zone.	755-1040	Permeability variable; tremendous flows of warm mineralized water recorded near the periphery of the Black Hills. Excellent potential.
Pennsylvanian	Minnelusa Fm.	Cml				
Mississippian	Pahasapa Fm.	Cps		Massive, light colored dolomite and limestone, cavernous in upper 100 feet	165-465	Most promising aquifer in the area. The 2 wells in this aquifer produce large amounts of water suitable for domestic use
Precambrian	Metamorphic and igneous rocks	PC		Granite, schists, quartzite, and slates.	---	No potential.





outcrop area, and water flows from numerous wells in the area at ground surface.

The Fall River and Lakota formations which form the Inyan Kara Group are the principal aquifers in the region. The alluvium is used locally as a source of domestic and stock water. The Sundance formation is used near its outcrop area in central and northwestern Fall River County. The Pahasapa (Madison) formation is locally accessible only by very deep wells and is the source for five wells in the city of Edgemont.

The Fall River and Lakota aquifers are of primary concern because of the potential impact of mine dewatering on the numerous wells developed in these aquifers in the vicinity of the mine. At the proposed mine site, the Fall River consists of approximately 120 feet of interbedded fine-grained sandstone, siltstone and carbonaceous shale. The Fall River aquifer is overlain by approximately 250 feet of the Mowry and Skull Creek shales unit, which act as confining beds. Twenty-six domestic and stock-watering wells are known to be developed in the Fall River formation within a four-mile radius of the mine site. Many of these are flowing at the surface.

The Fall River formation is underlain by Fuson shale member of the Lakota formation. Thickness of the Fuson is on the order of 60 feet in the site vicinity. The Fuson acts as a leaky aquitard between the Fall River and Lakota aquifers. A physical examination of undisturbed core samples of Fuson indicates that the shale itself has a very low permeability. However, aquifer tests suggest a direct connection through the Fuson which may be the result of some as-yet-unidentified structural features or old unplugged exploration holes.



The Chilson member of the Lakota formation is the second most widely used aquifer in western Fall River County, as the source for some 23 wells within a four-mile radius of the mine site. It is also the uranium-bearing unit to be mined. The Chilson consists of about 120 feet of consolidated to semi-consolidated, fine-grained sandstone and siltstone. It is underlain by the Morrison formation consisting of interbedded shale and fine-grained sandstone. Regionally, the Morrison is not considered an aquifer. Under conditions of groundwater withdrawal from the Chilson, the Morrison is expected to act as an aquitard.

Recharge to the Fall River and Lakota aquifers is believed to occur at their outcrop areas. Bowles (1968) has theorized that recharge to these aquifers may also be derived from the upward movement of ground water along solution collapses and breccia pipes from the deeper Minnelusa and Pahasapa aquifers. The solution collapse and breccia pipe features lie within the Dewey and Long Mountain structural belts.



AQUIFER TEST DESIGN

The objective of the aquifer testing program was to obtain sufficient quantitative information about local hydrogeologic conditions to enable prediction of mine dewatering requirements and impacts to both the Fall River and Lakota aquifers. Since the two aquifers involved are separated by the Fuson aquitard, two distinct pumping tests were required to obtain the necessary information about each formation: one test in which the Lakota aquifer was pumped, and another in which pumping was limited to the Fall River aquifer. During both tests ground-water levels were monitored in observation wells developed in each of the three formations. Data obtained from these tests were then analyzed to obtain estimates of the hydraulic properties of the aquifers and aquitard.

The Burdock test well was constructed approximately 600 feet north of the proposed mine shaft. Total depth of the well is 559 feet. The well is screened in both the Fall River and Lakota aquifers as shown in Figure 2.

Fifteen observation wells were constructed within an approximate one-mile radius of the pumping well as indicated in Figure 3. Seven of these wells are developed in the Fall River formation, five in the Lakota, and three in the Fuson. In addition, there is a single well developed in the Sundance formation located approximately one mile from the test well. This well was not constructed specifically for the aquifer tests, but was monitored periodically during the Lakota aquifer test. Construction details for these wells are given in Table 2.



TABLE 2. Observation Well Construction Details

<u>Well No.</u>	<u>Total Depth (feet)</u>	<u>Casing Diameter (inches)</u>	<u>Depth Interval of Open Borehole or Well Screen (feet)</u>	<u>Distance From Pumped Well (feet)</u>
B-10LAK	550	4	510-550	195
B-10FU	395	4	377-395	255
B-10FR	350	4	300-350	177
B-11LAK	570	4	525-570	405
B-11FU	440	4	420-440	350
B-11FR	376	4	334-376	373
B-11LAK	550	4	504-550	618
B-11FR	360	4	315-360	620
B-9LAK	545	1	503-545	1540
B-9FR	293	1	251-293	1540
B-7LAK	441	1	399-441	2507
B-7FR	252	1	210-252	2540
Sundance Well	880	7 7/8	666-780	4763



Inasmuch as water levels in each hydrogeologic unit will respond differently during pumping tests, it is important that each observation well reflect the potentiometric head in the intended uncased borehole interval. Several observation wells used in previous tests were suspected of leaking along the grout seal placed in the annular space between well casing and borehole wall. As a result, special precautions were taken to ensure proper construction of the observation wells used in the present tests. A geophysical device known as a cement logging probe was used to check the continuity of the cement grout seal in each well after construction. All were found to be properly sealed.

The so-called ratio-method of multiple-aquifer test analysis (Neuman and Witherspoon, 1973) requires that the response of water levels in both the pumped and unpumped aquifers and in the intervening aquitard be monitored during the test. Water level responses in these units must be measured in wells located at approximately the same radial distance from the pumped well. To obtain the necessary data, two groups of observation wells were constructed, each group having one well developed in the Fall River, one in the Fuson, and one in the Lakota (Chilson member). The B-10 group was located approximately 200 feet northeast of the pumping well, while the B-1 group was located approximately 375 feet to the southwest. These well groups were located close to the pumped well to ensure response in the aquitard and in the unpumped aquifer, if such responses were to occur at all. The remaining well groups (B-7, B-9 and B-11 series) contain only Fall River and Lakota wells.



Under natural conditions, the test well and all monitor wells except for those of the B-7 group flow at ground surface if not capped. The two previous tests conducted at the site indicated that observation wells in the pumped aquifer located close to the pumping well would become non-flowing at some point during the test. Thus, pressure sensing devices would be required during the early part of the test and depth measuring techniques during later periods. To ensure adequate data records, each flowing well was equipped with two pressure measuring devices. Malfunctions of several pressure gauges on previous tests pointed out the need for a back-up pressure measuring device.

Three types of pressure sensors were used: mercury manometers, electronic pressure transducers, and mechanical pressure gauges. The B-1 and B-10 observation well groups were equipped with mercury manometers and pressure transducers. As the closest wells to the pumping center, the data from these wells are most important in the multiple aquifer analysis and warrant the best instrumentation. Pressure transducers from all wells were wired to a central terminal and could be monitored frequently during the tests. Each well in groups B-9 and B-11 was equipped with a mercury manometer and a mechanical pressure gauge. Electric probes were used to measure water levels in the non-flowing wells of the B-7 group. These devices were also used to measure water levels in other wells which became non-flowing during pumping tests. Potentiometric head in the pumped well was measured with a mercury manometer, an air line and an electric probe.



LAKOTA AQUIFER TEST

Several months prior to the Lakota test, a pneumatic packer was set within the Fuson section of the test well to prevent communication between the Fall River and Lakota aquifers through the well. A submersible pump was set below packer to restrict pumping to the Lakota aquifer. Well-head valves on the test well and other artesian observation wells were closed to prevent flow in order to bring the ground-water system into equilibrium before testing.

Hydrographs for the test well and observation wells prior to test are shown in Figures 4 and 5. These hydrographs typify the basic relationship between the potentiometric heads in the Fall River, Fuson and Lakota, i.e., heads are highest in the Lakota, lowest in the Fall River, and at an intermediate position within the Fuson. The irregular readings recorded during January and February 1979 were due to depressurization of the aquifers during the installation of instrumentation and new wells. The pre-test ground-water level configuration in the Lakota aquifer on April 18 is shown in Figure 6.

Test Procedures and Results

A constant-discharge aquifer test was initiated at 1300 hours on April 18, 1979. Discharge from the well was pumped via pipeline to a stock-watering pond located approximately 0.75 miles from the test well. Pumpage was measured with an in-line flow meter and with an orifice plate and manometer device at the end of the discharge line. The pumping rate varied little during the test ranging from 201 to 205 gpm and averaging 203 gpm. The pumping phase of the test lasted for



73 hours (3.04 days) and was followed by a 30 day period of recovery measurements.

Figure 7 shows a semilogarithmic graph of drawdown (s) versus time (t) for the pumping well (Lakota aquifer). Erratic readings during the first 200 minutes of the test are the result of problems with the airline equipment, and are not due to discharge variations. These difficulties were subsequently corrected, but in general airline measurements are believed to be accurate only to within about ± 2 feet.

Semilog graphs for the observation well groups are shown in Figures 8 through 12. Note that a slight initial increase in hydrostatic pressure is indicated in the Fall River and Fuson wells of the B-10 and B-1 well groups. This anomalous trend is more pronounced in the Fuson wells than in the Fall River wells and persists for approximately 90 minutes in B-10FU. The response is believed to be due to an increase in pore pressure resulting from deformation of the matrix of these formations.¹ In any case, the anomalous trend was recorded by both the pressure transducers and mercury manometers, and is not the result of measurement error.

The Jacob straight-line method (see Walton, 1970, pp. 130-133) was applied to the semilog graphs for the Lakota wells to obtain the values of transmissivity (T) and storativity (S) presented in Table 3. In the case of the closer observation wells, two straight-line

¹During the early stages of pumping, water removed from the Lakota in the immediate vicinity of the well causes compaction of the aquifer. This, in turn, may cause the overlying strata to flex slightly in the area where the underlying support of the Lakota has been reduced. The resulting deformation in the overlying formations causes compressive forces which temporarily increase pore pressures in these materials. Subsequently, the effect of pumping-induced depressurization is transmitted through the overlying materials, gradually lowering the hydrostatic pressure.

TABLE 3. Lakota Aquifer Properties

Well No.	r (ft)	Jacob Method				Theis Method				Recovery Method	
		T_e (gpd/ft)	S_e --	T_l (gpd/ft)	S_l --	T_e (gpd/ft)	S_e --	T_l (gpd/ft)	S_l --	T_e (gpd/ft)	T_l (gpd/ft)
PW-LAK	0.67	1980	--	1260	--	--	--	--	--	--	--
B-10LAK	195	2680	7.6×10^{-5}	1370	3.5×10^{-4}	2530	8.4×10^{-5}	1660	1.6×10^{-4}	2060	1300
B-11LAK	405	2140	4.4×10^{-5}	1340	1.2×10^{-4}	2120	4.8×10^{-5}	1550	8.4×10^{-5}	1970	1240
B-111LAK	620	--	--	--	--	2530	1.1×10^{-4}	1530	1.5×10^{-4}	--	1250
B-9LAK	1540	--	--	--	--	--	--	1370	1.3×10^{-4}	--	1290
B-7LAK	2507	--	--	--	--	--	--	1760	6.5×10^{-5}	--	1500
Average:		2270	6.0×10^{-5}	1320	2.4×10^{-4}	2390	8.1×10^{-5}	1570	1.2×10^{-4}	2015	1270

NOTE: Subscript "e" denotes an aquifer parameter determined using early drawdown (or recovery) data. Similarly, subscript "l" denotes a parameter computed from late data.



solutions were possible: one using the early data and another using the late data. Note that data for wells B-7L, B-9L and B-11L cannot be analyzed by the Jacob method because data do not satisfy the criterion that $r^2S/4Tt \leq 0.01$ (consistent units), where r is the distance between the pumped well and the observation well.

Logarithmic graphs of drawdown data for all observation wells are given in Figures 13 through 17. Their curve-matching techniques (Walton, 1970, pp. 209-211) were applied to the Lakota curves to obtain T and S estimates for the Lakota aquifer. As with the Jacob analyses, two curve-match solutions were possible: one using the early, steeply-rising portions of the s - t curves, and another using the later data. Both solutions are given in Table 3.

A semilogarithmic graph of distance versus drawdown (Figure 18) was constructed by plotting the final drawdown in each Lakota well versus its radial distance from the pumped well. The Jacob straight-line techniques were applied to these data to obtain T and S values for the Lakota of 1780 gpd/ft and 7.7×10^{-5} , respectively. However, this type of analysis is applicable only to nonleaky aquifer systems. Since leakage obviously occurred during the test, the results are considered unreliable.

Contour maps of the final drawdown in the Lakota and Fall River aquifers at the end of the test are shown in Figures 19 and 20, respectively. The drawdown cone in both aquifers is slightly elongated in a northwesterly direction. This is probably an indication of anisotropic transmissivity, with the transmissivity in the direction parallel to the axis of elongation being somewhat greater than that in the direction normal to the axis of elongation. The principal direction of trans-



missivity parallels the strike of a regional fracture-joint set, suggesting a possible explanation for the observed drawdown configuration.

Following the pumping phase of the test, water level recovery measurements were made at all observation wells for a period of 30 days. Attempts were also made to monitor recovery in the pumped well using an airline. However, data collected were highly erratic suggesting a malfunction of the airline equipment. Semilogarithmic graphs of residual drawdown versus t/t' (ratio of time since pumping started to time since pumping stopped) for the observation wells are shown in Figures 21 through 25. Lakota graphs were analyzed using Jacob straight-line techniques to obtain the estimates of transmissivity presented in Table 3. Again, two straight-line fits are possible for the closer Lakota wells. Both are given in Table 3.

Interpretation of Test Results

The drawdown trends recorded in the observation wells indicate some important qualitative information about hydrogeologic conditions at the proposed mine site, in addition to providing a basis for determining hydraulic properties of materials. The relative response of the Fall River, Fuson and Lakota formations as reflected in the B-10 and B-1 groups (Figures 13 and 14), is not typical of the response that would be expected in an ideal leaky multiple aquifer system. Ideally, the $s-t$ curve for the intervening aquitard lies between the curves for the pumped and unpumped aquifers. That is, in a logarithmic plot of $s-t$ data the aquitard (Fuson) curve would lie below the curve for the pumped aquifer (Lakota), and above the curve for the unpumped aquifer (Fall River). However, "ideal" trends are not evident in the



observed data until after 300 minutes of pumping in the case of the B-10 group, and not until after 2000 minutes in the case of the B-1 group. The fact that a greater pumping response is observed in Fall River formation than in the Fuson during the early part of the test indicates that direct (though restricted) avenues through the Fuson must exist. This condition was suspected before the test, and is believed to be the result of numerous old, unplugged uranium exploration boreholes in the test site vicinity. The shift to a more ideal relationship among the s-t curves exhibited during the latter part of test possibly indicates that general leakage through the Fuson itself has caught up with leakage through the open boreholes.

The leakage condition which is apparent in the response of the Fuson and Fall River wells is not evident in the Lakota well data. Under ideal conditions, the rate of drawdown in the Lakota observation wells would be expected to gradually decrease and perhaps even level off completely for some period of time. However, the opposite effect is noted in Lakota s-t plots, particularly the semilog graphs for B-10 LAK and B-1 LAK (Figures 8 and 9). The rate of drawdown increases in the latter stages of pumping which might indicate decreasing transmissivity of the Lakota aquifer in the site vicinity. The decrease in transmissivity may be due to aquifer thinning or possibly a facies change to less permeable materials. In any case, it is suspected that the leakage effects in the Lakota drawdown data are masked by the conflicting effect of a decreasing transmissivity in the site vicinity.

In general, the agreement between the Theis and Jacob analyses of s-t data is good. T values computed using early drawdown data average 2390 gpd/ft using the Theis method, and about 2270



gpd/ft using the Jacob method. Early data storativities are also in good agreement averaging 6.0×10^{-5} for the Jacob method and 8.1×10^{-5} for the Theis method. The T values computed from the late data (T_{ℓ}) are significantly lower than those determined from the early data, whereas late storativities are larger. The Jacob method yields T_{ℓ} values which average 1320 gpd/ft and storativities averaging 2.4×10^{-4} . The Theis method produced an average T_{ℓ} of 1570 gpd/ft and an average S_{ℓ} of 1.2×10^{-4} . The late Theis T values are somewhat higher than the Jacob T's because the Theis method gives some consideration to the earlier data which the Jacob method does not. Transmissivities estimated by the recovery data average 1270 gpd/ft, and are in close agreement with the late Jacob results, although slightly lower.

Ordinarily, in selecting representative T and S for the pumped aquifer in a leaky multiple aquifer system, more emphasis would be placed on the early data collected in the pumped aquifer at the pumped well and closest observation wells. These data are considered least affected by leakage. However, because of the apparent decrease in transmissivity of the Lakota aquifer during the latter stages of the test, it is believed that Lakota parameters computed from the late data are more representative of aquifer properties under a long-term pumping situation such as mine dewatering. On this basis the average transmissivity of the Lakota is estimated to be 1400 gpd/ft and the average storativity 1.8×10^{-4} .



FALL RIVER AQUIFER TEST

Following completion of recovery measurements associated with the Lakota aquifer test, pumping equipment in the Burdock well was rearranged for the Fall River test. A submersible pump was set within the Fall River section of the well and the pneumatic packer reset below the pump in the Fuson section of the well in order to restrict pumping to the Fall River. A preliminary test of the pump and other equipment lasting less than one hour was conducted on May 29. Unexpectedly, the Fall River aquifer was capable of yielding only about 10 gpm on a sustained basis. Since other Fall River wells in the region yield up to 40 gpm, it was assumed that either the well screen was encrusted or the well was not fully developed, or both. An unsuccessful effort was made to develop the well by pumping. A television camera was subsequently lowered into the well to examine the well screen. Little or no encrustation was observed on the screen. Ultrasonics were used in the well to remove any existing encrustation but the yield of the well was not improved. The low productivity of the well is, therefore, attributed to locally poor water-bearing characteristics of the Fall River formation.

Test Procedures and Results

A constant discharge test commenced at 1100 hours on July 24. Water levels in all geologic units were stable prior to the test, as there was no pumping activity in the site vicinity since the completion of well development on July 3. Discharge was measured with an in-line flowmeter, and checked with a 55-gallon container and stopwatch.



During the test the pumping rate varied from 7.6 to 10.4 gpm, and averaged 8.5 gpm. Ground-water levels were monitored in all observation wells shown in Figure 3. The constant discharge test was terminated at 1200 hours on July 26 after 49 hours of pumping. Subsequently, ground-water level recovery measurements were made for a period of six days.

Semilog graphs of drawdown data recorded at the pumped well and observation well groups B-1, B-10 and B-11 are shown in Figures 26 through 29, respectively. No graphs are presented for B-11LAK or the B-7 and B-9 groups as there was no measureable drawdown in these wells. Except for B-11FR, these graphs exhibit a typical straight-line drawdown trend during the first part of the test, followed by a gradual decrease in slope towards the end of the test. This slope change is the result of leakage from adjacent formations, and/or an increase in aquifer transmissivity at some distance from the pumped well. The Jacob method was applied to the semilog graphs to obtain the transmissivity and storativity values shown in Table 4. The T_e and S_e values were obtained using early drawdown data recorded during approximately the first 500 minutes of the test. T_1 and S_1 values were computed from data recorded after about 1000 minutes. The only reliable estimates are considered to be those computed for B-1FR and B-10FR. Drawdown data for the pumped well is affected by wellbore storage which is significant in this test because of the relatively low pumping rate. The pumped well drawdown data may also be affected by low well efficiency. The semilog plot for B-11FR cannot be analyzed by the Jacob method because the criterion that $r^2S/4Tt \leq 0.01$ is not satisfied for any of the data.

TABLE 4. Fall River Aquifer Properties

Well No.	r (ft)	Jacob Method				Theis Method		Recovery Method	
		T_e (gpd/ft)	S_e --	T_l (gpd/ft)	S_l --	T_e (gpd/ft)	S_e --	T_e (gpd/ft)	T_l (gpd/ft)
PW-FR	0.67	16.(?)	--	--	--	--	--	11(?)	--
B-10FR	177	140.	1.8×10^{-5}	410.	--	150.	1.7×10^{-5}	80.	340.
B-1FR	373	150.	0.8×10^{-5}	420.	--	150.	1.1×10^{-5}	90.	350.
B-11FR	618	--	--	--	--	--	--	--	--
Average:		145	1.3×10^{-5}	415.	--	150.	1.4×10^{-5}	85.	345.



Logarithmic graphs of drawdown data for the pumped well and observations well groups B-10, B-1 and B-11 are presented in Figures 30 through 33, respectively. These curve-matching techniques were applied to the Fall River curves to obtain the aquifer properties given in Table 4.

Semilog recovery curves for the pumped well and well groups B-10, B-1 and B-11 are shown in Figures 34 through 37, respectively. Again, properties computed from the pumped well recovery data are invalidated by well-bore storage effects. Separate estimates of transmissivity obtained from early and late phases of the recovery data are given in Table 4.

Interpretation of Fall River Aquifer Test Results

There is good agreement between the early Jacob and Theis results for B-1FR and B-10FR. These analyses indicate an average T_e of about 150 gpd/ft and an average S_e of approximately 1.4×10^{-5} . Application of the Jacob method to the late drawdown data yields an average T_1 of 415 gpd/ft. No meaningful storativity values could be computed from the late data. The T_e values computed by the recovery method are considerably lower than those computed by the other two methods and are believed to be unrealistic. The T_1 values derived from the recovery analyses compare reasonably well with the Jacob late drawdown results.

The computed transmissivity and storativity values are representative of the aquifer only within the relatively small area influenced by the pumping test. The yield of the test well is substantially less than that of several other wells in the region. The difference in well



yields suggests that the Fall River aquifer is less permeable in the mine site vicinity than in certain surrounding areas. The aquifer parameters computed from the early drawdown and recovery data are believed to be representative of the aquifer in the immediate vicinity of the test wells. Parameters obtained from analysis of the late data are probably more representative of regional aquifer characteristics.



FUSON AQUITARD PROPERTIES

The hydraulic properties of the Fuson aquitard were estimated using an analytical technique known as the "ratio method" developed by Neuman and Witherspoon (1973). The method requires (1) a knowledge of the transmissivity and storativity of the pumped aquifer; (2) draw-down data for the pumped and unpumped aquifers and the aquitard measured in wells located at approximately the same radial distance from the pumped well; and (3) the vertical distance between the aquifer-aquitard boundary and the perforated section of each aquitard well (Z). The method yields a value of aquitard hydraulic diffusivity, α' , equal to K'_v/S'_s , where K'_v is the vertical hydraulic conductivity of the aquitard and S'_s is the specific storativity of the aquitard. To determine K'_v or S'_s from α' , either K'_v or S'_s must first be known. In the following analyses a value of $S'_s = 10^{-6} \text{ ft}^{-1}$ is assumed for the Fuson aquitard. Experience indicates that specific storativities of geologic materials do not vary over as wide a range as do hydraulic conductivities. For this reason, and considering the difficulty and expense of obtaining an accurate measure of S'_s over the site vicinity, it appears justifiable to assume a value of S'_s typical of similar geologic materials.

The first step in the analysis is to compute a value of s'/s at a given radial distance from the pumped well, r , and at a given time, t . Next a value of t_D (dimensionless time for the aquifer equal to tT/r^2S) is determined. The values of s'/s and t_D are used to compute a value for t'_D (dimensionless time for the aquitard equal to $K't/S'_sZ^2$) using a family of type curves given in Figure 3 of Neuman and Witherspoon (1973). The vertical hydraulic conductivity of the aquitard K'_v is then obtained from the following equation:



FUSON AQUITARD PROPERTIES

The hydraulic properties of the Fuson aquitard were estimated using an analytical technique known as the "ratio method" developed by Neuman and Witherspoon (1973). The method requires (1) a knowledge of the transmissivity and storativity of the pumped aquifer; (2) draw-down data for the pumped and unpumped aquifers and the aquitard measured in wells located at approximately the same radial distance from the pumped well; and (3) the vertical distance between the aquifer-aquitard boundary and the perforated section of each aquitard well (Z). The method yields a value of aquitard hydraulic diffusivity, α' , equal to K'_v/S'_s , where K'_v is the vertical hydraulic conductivity of the aquitard and S'_s is the specific storativity of the aquitard. To determine K'_v or S'_s from α' , either K'_v or S'_s must first be known. In the following analyses a value of $S'_s = 10^{-6}$ is assumed for the Fuson aquitard. Experience indicates that specific storativities of geologic materials do not vary over as wide a range as do hydraulic conductivities. For this reason, and considering the difficulty and expense of obtaining an accurate measure of S'_s over the site vicinity, it appears justifiable to assume a value of S'_s typical of similar geologic materials.

The first step in the analysis is to compute a value of s'/s at a given radial distance from the pumped well, r , and at a given time, t . Next a value of t_D (dimensionless time for the aquifer equal to tT/r^2S) is determined. The values of s'/s and t_D are used to compute a value for t'_D (dimensionless time for the aquitard equal to $K't/S'_sZ^2$) using a family of type curves given in Figure 3 of Neuman and Witherspoon (1973). The vertical hydraulic conductivity of the aquitard K'_v is then obtained from the following equation:



$$K'_v = t'_D Z^2 S'_s/t \quad (1)$$

Since separate pumping tests were conducted in the Lakota and Fall River aquifers, it is possible to calculate two independent values of K'_v for each well group. Fuson aquitard properties computed by the ratio method along with certain pertinent parameters used in the calculations are presented in Table 5.

Note that since the Fall River, Fuson and Lakota observation wells in each well group do not lie at exactly the same radial distance from the pumped well, an average radial distance r_{avg} is used in the calculations. The r_{avg} values shown in Table 5 were obtained by averaging the radial distance for the pumped aquifer observation well and the radial distance for the aquitard observation well. Also note that the column labeled "Time Interval" represents the time interval during which K'_v values were computed. Generally, three or four values of K'_v were computed at specific times within this interval. These values were then averaged to obtain the K'_v values shown in Table 5.

The vertical hydraulic conductivity of the Fuson ranges from about 10^{-4} ft/d at the B-1 well group to about 10^{-3} ft/d at the B-10 well group. The agreement between the conductivities computed at each well group site for both tests is good. The reason for the order of magnitude difference between the conductivities at the different well sites is unknown, but may be related to errors caused by differences in the radial distances of observation wells--these differences being somewhat greater for the wells of the B-10 group.



TABLE 5. Fuson Aquitard Properties

<u>Test</u>	<u>Well Group</u>	<u>r_{avg.} (ft)</u>	<u>Z (ft)</u>	<u>Time Interval (min.)</u>	<u>(gpd/ft²)^{K'_v}</u>	<u>(ft/d)</u>
Lakota	B-10	225	28	100-393	2.0×10^{-2}	2.7×10^{-3}
	B-1	378	11	100-393	1.0×10^{-3}	1.3×10^{-4}
Fall R.	B-10	216	25	100-300	4.8×10^{-3}	6.6×10^{-4}
	B-1	362	40	1200-2350	1.3×10^{-3}	1.8×10^{-4}



The magnitudes of computed conductivities are slightly higher than expected on the basis of the physical characteristics of the Fuson, although they are still within reason. The presence of open boreholes may have caused a more rapid drawdown response in the Fuson monitor wells than would have occurred otherwise. As a result, the calculated K'_v values are probably larger than the actual conductivity of the Fuson shale. The calculated K'_v values are, however, probably smaller than the effective K'_v of the aquitard in the areas where it is breached by open boreholes.

COMPUTER MODEL SIMULATIONS

The hydraulic properties estimated for the Fall River, Fuson and Lakota formations were incorporated into a computer model of the site geohydrologic system. Simulations of the Lakota aquifer test were performed to see if the model could reproduce the drawdown responses observed during the test. An acceptable match between the measured and computed responses would indicate the validity of the estimated formation properties, and thus enhance the credibility of the model for predicting mine dewatering requirements and impacts.

A finite element numerical model developed by Narasimhan et al. (1978) was used for the aquifer test simulations. The aquifer/well-field system was modeled in three dimensions using axial symmetry. The hydraulic properties of the Fall River, Fuson and Lakota formations obtained from the aquifer test analyses were used as initial input data (see Table 6). Uniform properties were assumed for each hydrogeologic unit. The shale units which lie above the Fall River formation and those which lie below the Lakota were assumed to be impermeable in the model. All simulation comparisons were made for the Lakota aquifer test. The Lakota test stressed a larger portion of the multiple aquifer system than did the Fall River test, and more closely approximates the flow regime expected during mine dewatering.

A comparison of the measured and computed results for the initial simulation run are shown in Figure 38. In general, the agreement between the computed and observed drawdown graphs for the Lakota aquifer are good. However, there are large discrepancies in the Fall River and Fuson responses.

TABLE 6. Parameters Used In Computer Simulations

Formation	Initial Parameters					Final Parameters				
	T (gpd/ft)	S (--)	K_v (ft/d)	K_v/K_h (--)	Ss (ft ⁻¹)	T (gpd/ft)	S --	K_v (ft/d)	K_v/K_h --	Ss (ft ⁻¹)
Fall River	150.	1.4×10^{-5}	5.6×10^{-2}	1/3	1.2×10^{-7}	400	1.4×10^{-5}	4.6×10^{-2}	1/10	1.2×10^{-7}
Fuson	0.13	6.0×10^{-5}	1.7×10^{-4}	1/3	1.0×10^{-6}	0.45	6.0×10^{-5}	1.0×10^{-3}	1/1	1.0×10^{-6}
Lakota (Chilson)	1400.	1.8×10^{-4}	5.0×10^{-1}	1/3	1.5×10^{-6}	1400.	1.0×10^{-4}	1.5×10^{-1}	1/10	8.3×10^{-7}



Several attempts were made to improve the match between the computed and observed drawdown responses by trial-and-error adjustment or calibration of model parameters. The most reliable parameters, such as the computed Lakota and Fall aquifer coefficients, were only slightly altered in the calibration process, whereas the least reliable parameters, including the ratio of vertical to horizontal permeability and the Fuson properties, were allowed to vary over a wider (though reasonable) range. The hydraulic properties within each hydrogeologic unit were assumed to be uniform throughout the calibration process.

The set of hydraulic parameters yielding the best agreement between measured and observed drawdown data is given in Table 6. The final parameter set differs only slightly from the original. The largest changes were made in the K_v/K_h terms which were unknown to begin with; and in the Fuson hydraulic conductivity which was increased by a factor of five. Both the early and late Fall River T values computed from the aquifer test analyses (150 and 415 gpd/ft, respectively) were tested during model calibration. The drawdown response of the model was found to be relatively insensitive to the value of T used. A transmissivity of 400 gpd/ft is included in the final parameter set as it is believed to be more characteristic of the aquifer regionally.

The match between the measured and computed drawdown responses, shown in Figure 39, is considered acceptable in light of the fact that uniform aquifer-aquitard properties were used in the model. The apparent discrepancies are believed to be due to the heterogeneity and anisotropy of the actual system. The departures which occur during the early phase of the simulation appear large, but are not significant.



The ability of the model to predict the long-term response of system is more important. Thus, more significance is attached to the agreement between the simulated and observed results for the latter part of the test which, in most cases, is quite good. The final set of aquifer-aquitard properties are considered to represent a valid basis for future predictive modeling.



SUMMARY AND CONCLUSIONS

The aquifer test results indicate that the Fuson member of the Lakota formation is a leaky aquitard separating the Fall River and Lakota aquifers. The hydraulic communication between the two aquifers observed during the tests is believed to be the result of (1) general leakage through the primary pore space and naturally occurring joints and fractures of the Fuson shale, and (2) direct connection of aquifers via numerous old unplugged exploratory boreholes. Whereas, the former leakage mechanism is a regional characteristic of the Fuson, leakage caused by borehole short-circuiting is probably limited to the relatively small area of intensive uranium exploration in the Burdock vicinity.

The Lakota (Chilson) aquifer has an estimated transmissivity of approximately 1400 gpd/ft and a storativity of about 1.0×10^{-4} . These properties are representative of the Lakota in the area affected by the pumping test, and are consistent with what is known or suspected about the aquifer regionally. The transmissivity and storativity of the Fall River aquifer are estimated at approximately 400 gpd/ft and 1.4×10^{-5} , respectively. Test results indicate that the transmissivity of the Fall River may be considerably less than 400 gpd/ft in the immediate vicinity of the test site. However, the selected transmissivity value is more consistent with regional aquifer characteristics.

The hydraulic conductivity of the Fuson aquitard is estimated at approximately 10^{-3} ft/d. The specific storativity of the Fuson was not measured but is assumed to be about 10^{-6} ft⁻¹. If open boreholes



are present at the test site as suspected, the computed hydraulic conductivity is probably higher than the true conductivity of the shale, yet lower than the effective conductivity of the aquitard where short-circuited by open boreholes. For this reason, the selected aquitard conductivity of 10^{-3} ft/d should provide a conservative estimate of mine dewatering impacts. Outside of the relatively small area where the aquitard is breached by boreholes, leakage between the two aquifers will be governed by the true conductivity of the shale which is probably on the order of 10^{-4} ft/d or less.

The hydraulic properties of the Fall River, Fuson and Lakota (Chilson) formations computed from aquifer test data were incorporated into a computer model of the site geohydrologic system. These parameters were refined through repeated simulations of the Lakota aquifer test until the model could reproduce the drawdown responses observed during the test. The agreement between the observed and computed responses indicates the validity of the aquifer-aquitard properties, and should enhance the credibility of future predictive models using these parameters.



REFERENCES

1. Gott, G. B., D. E. Walcott, and C. G. Bowles, "Stratigraphy of the Inyan Kara Group and Localization of Uranium Deposits, Southern Black Hills, South Dakota and Wyoming." USGS Prof. Paper 763, 1974.
2. Keene, J. R., "Ground-water Resources of the Western Half of Fall River County, South Dakota." Rept. of Inv. No. 109, S. D. Geol. Survey, 1973.
3. Narasimhan, T. N., S. P. Neuman, and P. A. Witherspoon, "Finite Element Method for Subsurface Hydrology Using a Mixed Explicit-Implicit Scheme," Water Resources Research, Vol. 14, No. 5, 1978.
4. Neuman, S. P. and P. A. Witherspoon, "Field Determination of the Hydraulic Properties of Leaky Multiple Aquifer Systems," Water Resources Research, Vol. 8, No. 5, 1973.
5. Walton, W. C., Groundwater Resource Evaluation, McGraw-Hill, New York, 1970.



APPENDIX

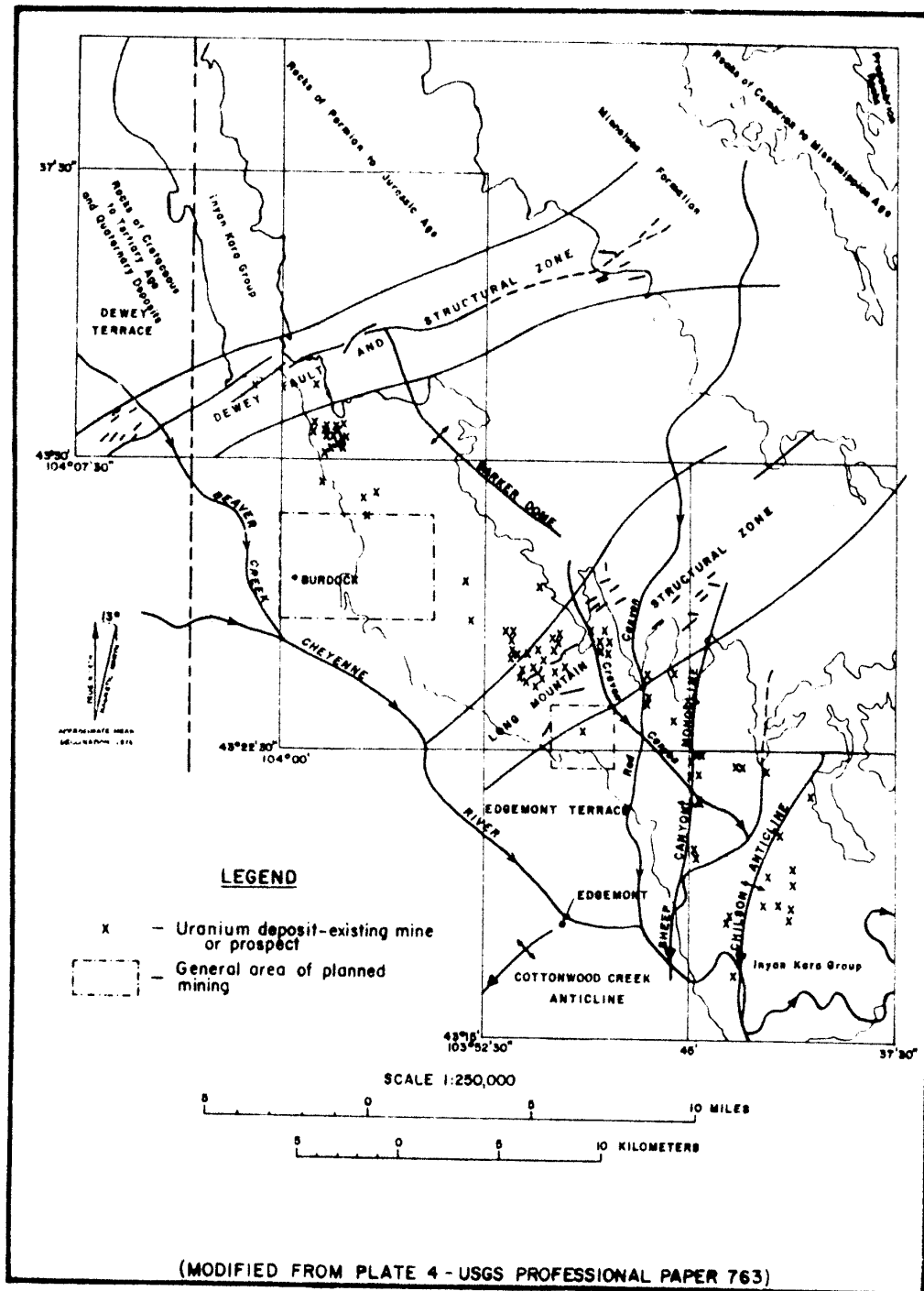

Figure 1 : Generalized Geologic Map of Site Region

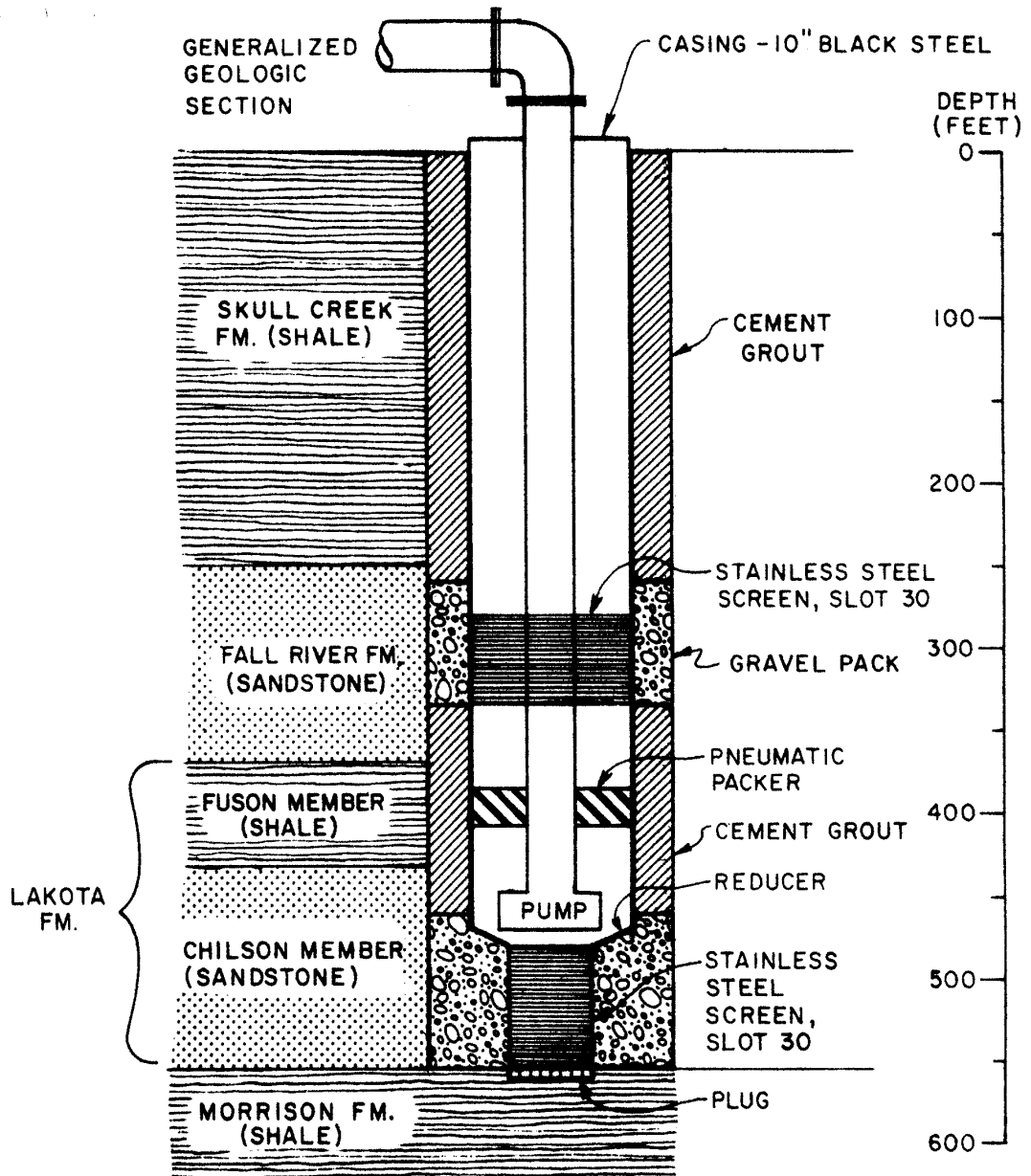

Figure 2 : Burdock Well Profile

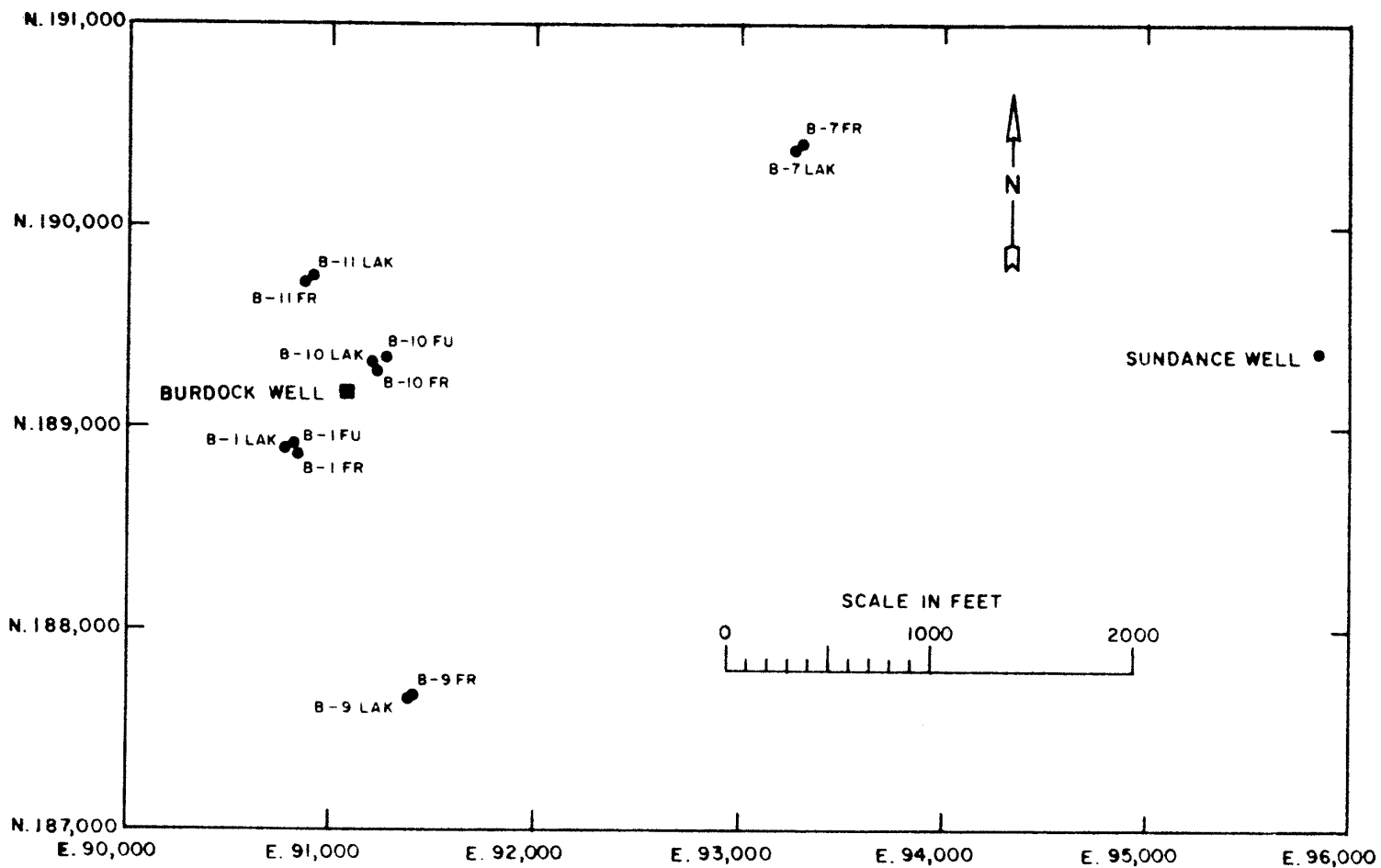

Figure 3: Well Location Map

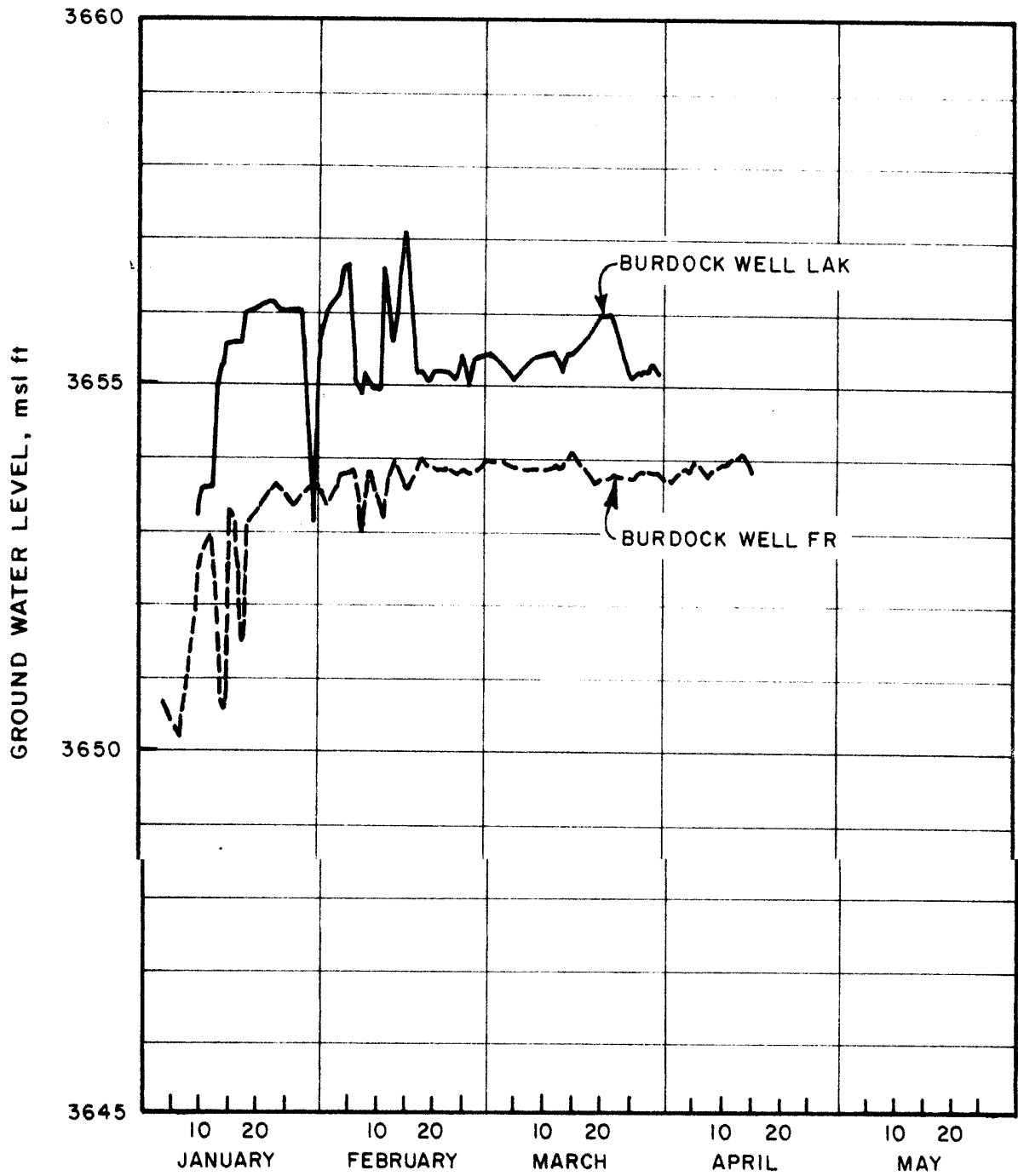

Figure 4 : Hydrographs for Burdock Test Well, January 1 through April 17, 1979

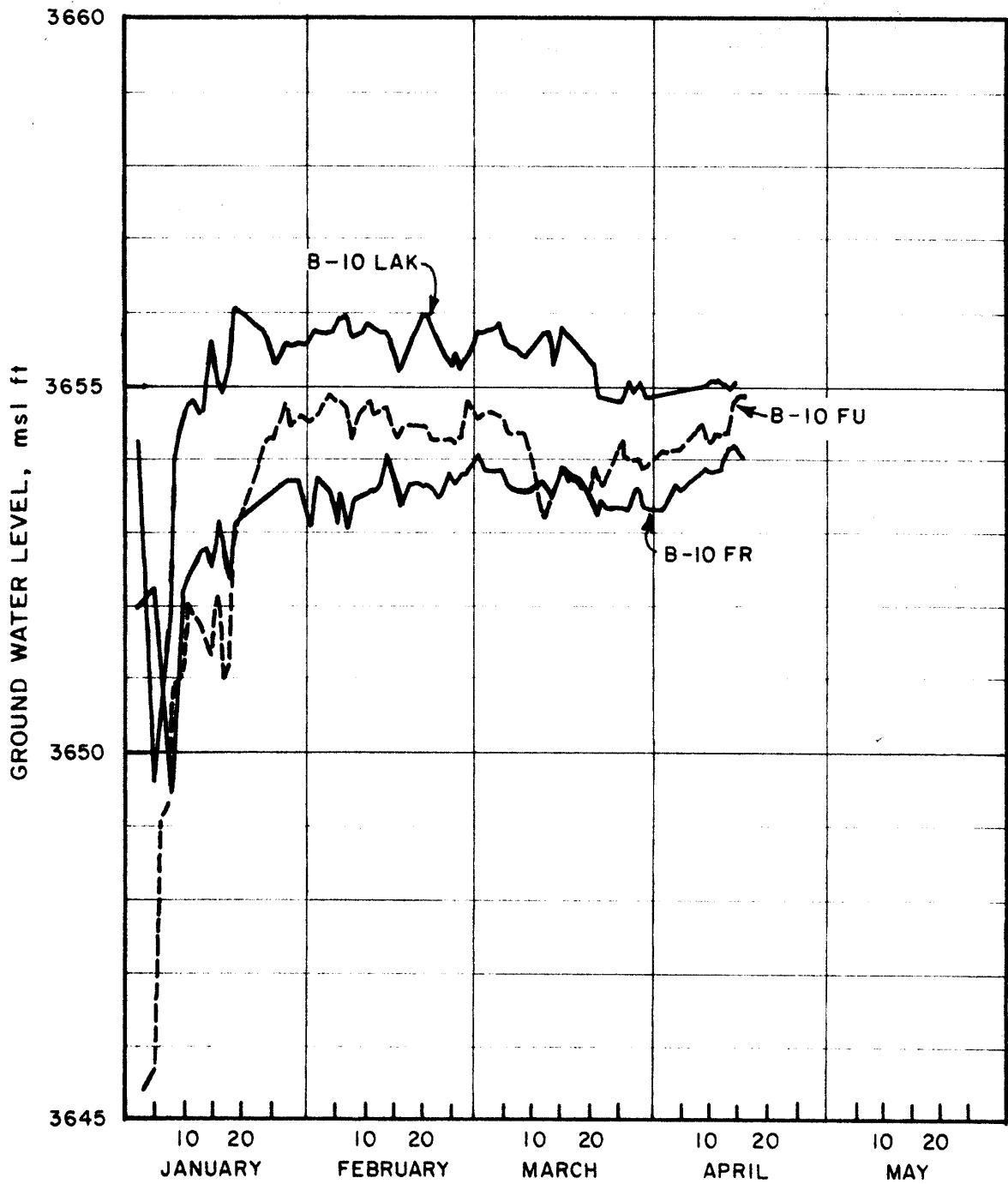

Figure 5 : Hydrographs for B-10 Observation Well Group, January 1 through April 17, 1979

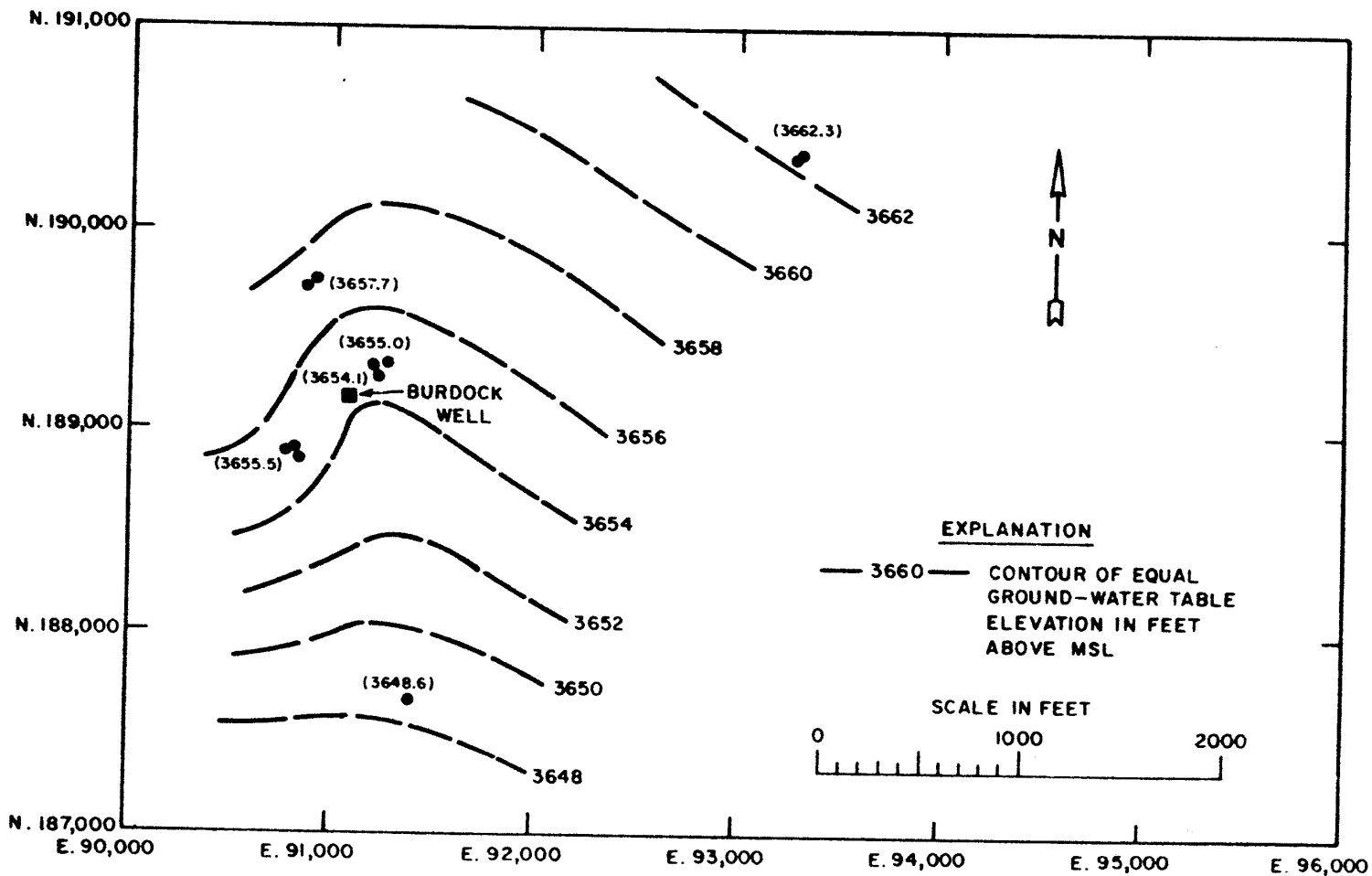

Figure 6 : Pre-Test Ground-Water Level Contour Map for Lakota Aquifer

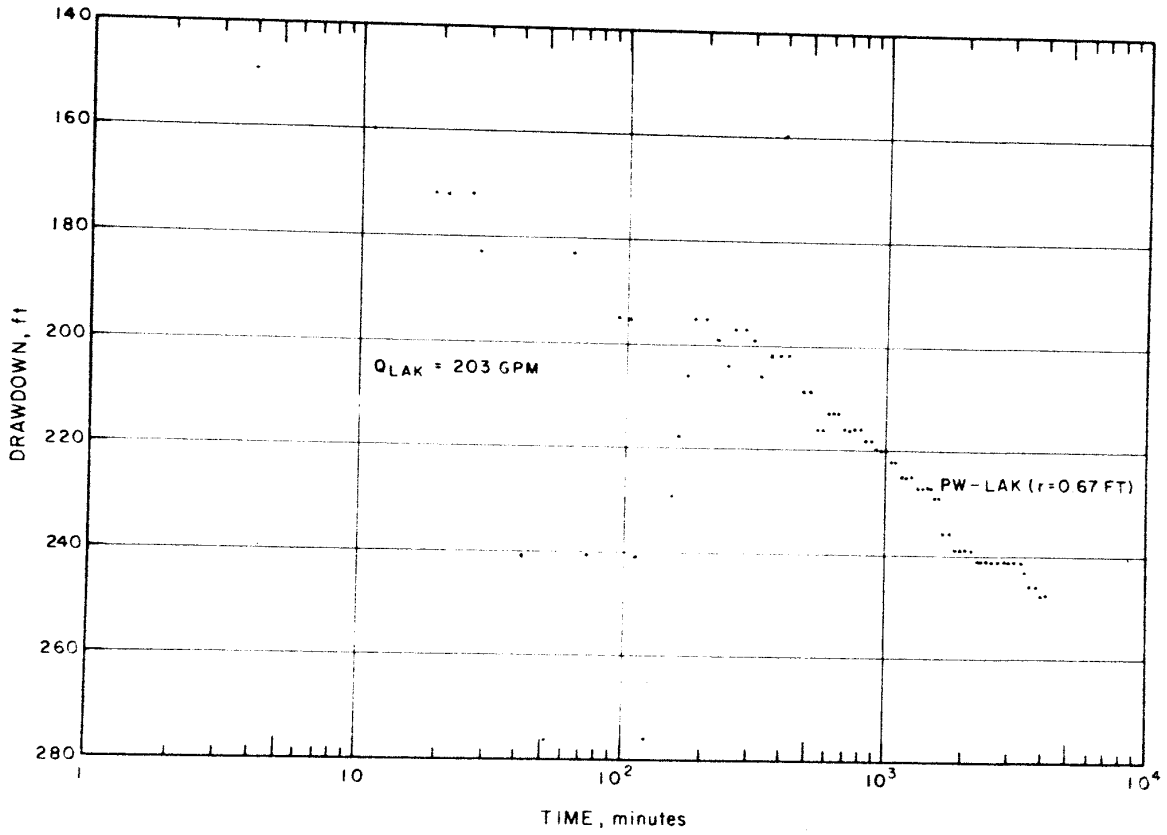

Figure 7: Semilogarithmic Graph of Drawdown for Pumped Well, Lakota Aquifer Test

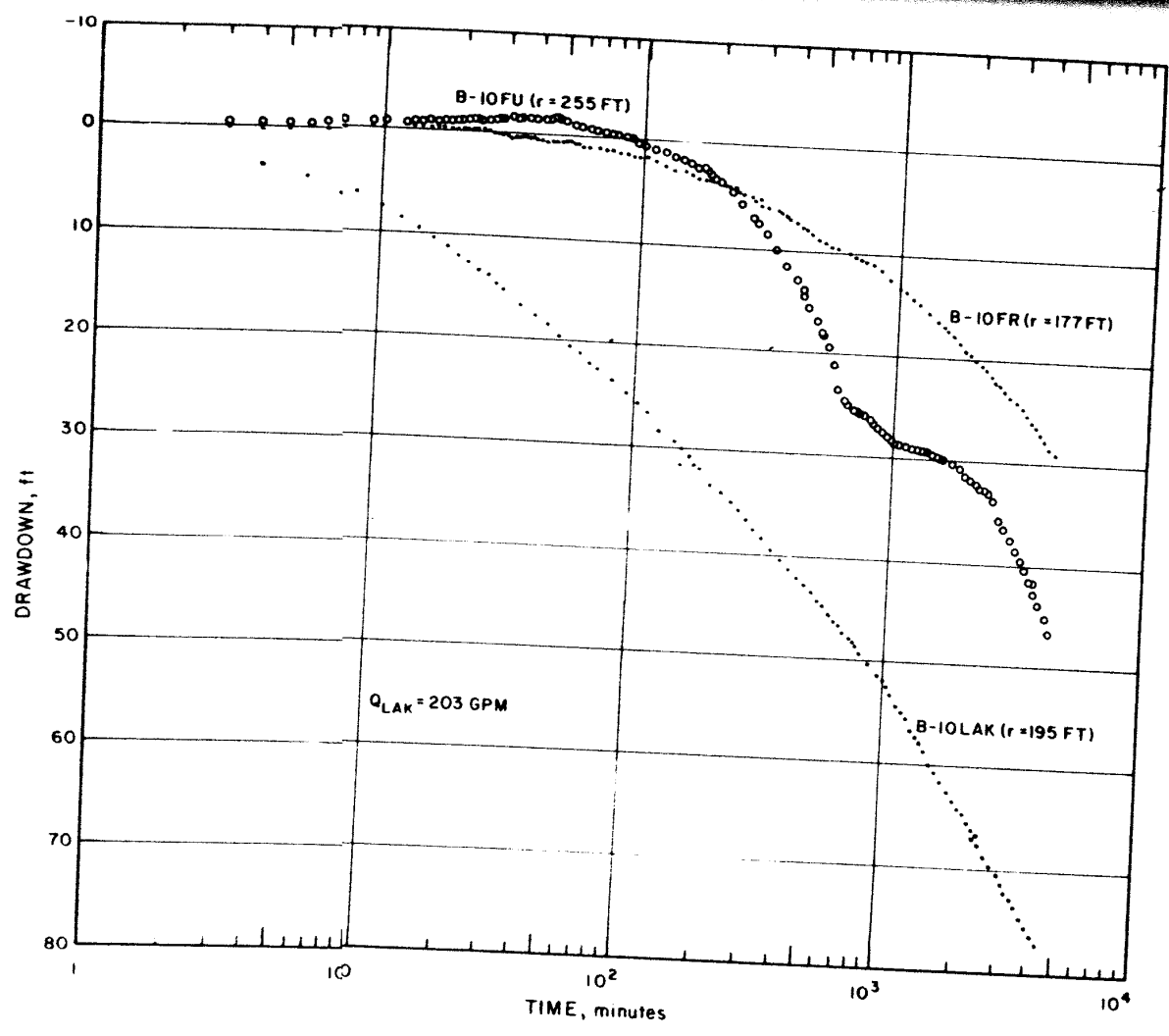

Figure 8 : Semilogarithmic Graphs of Drawdown for B-IO Observation Well Group, Lakota Aquifer Test

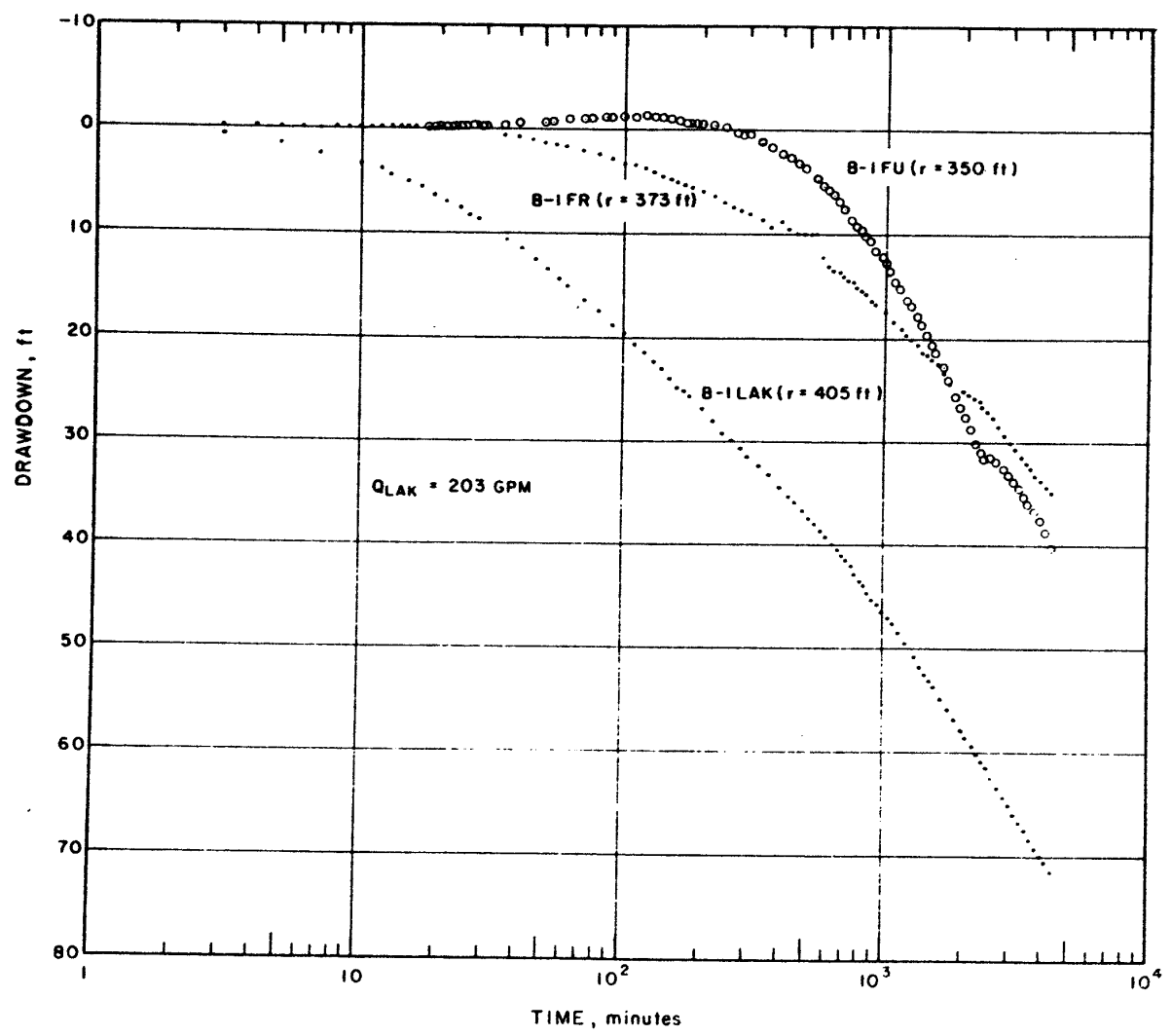

Figure 9: Semilogarithmic Graphs of Drawdown for B-I Observation Well Group, Lakota Aquifer Test

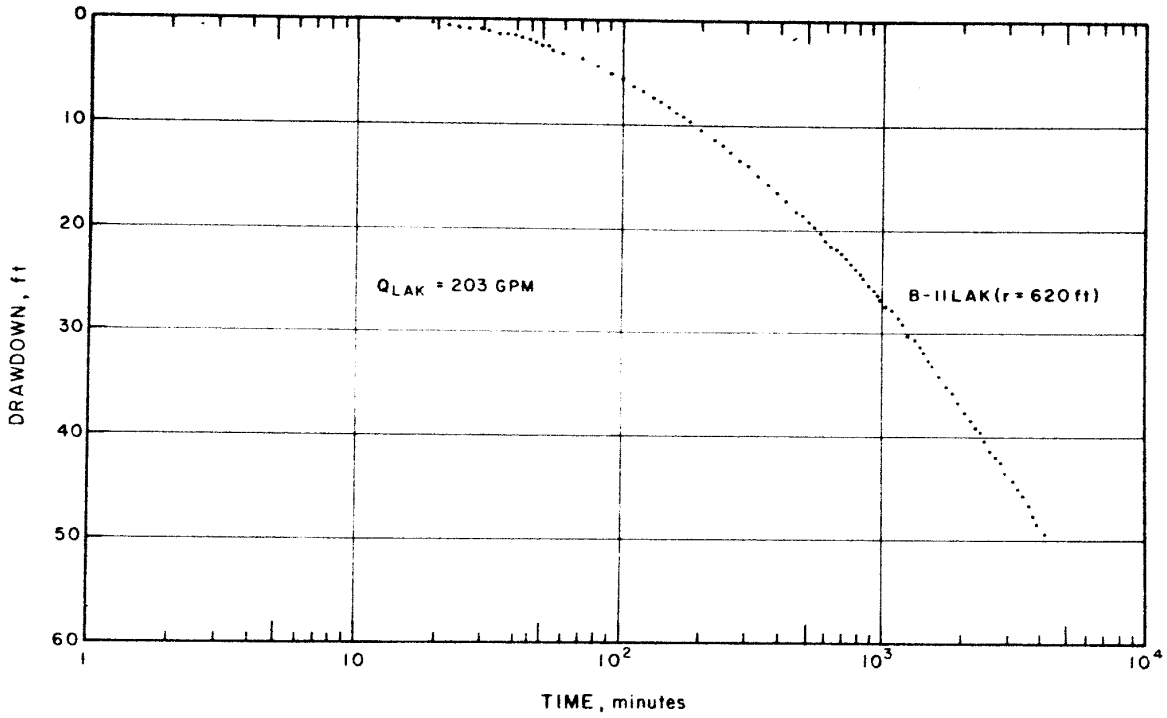

Figure 10: Semilogarithmic Graph of Drawdown for B-II Observation Well Group, Lakota Aquifer Test

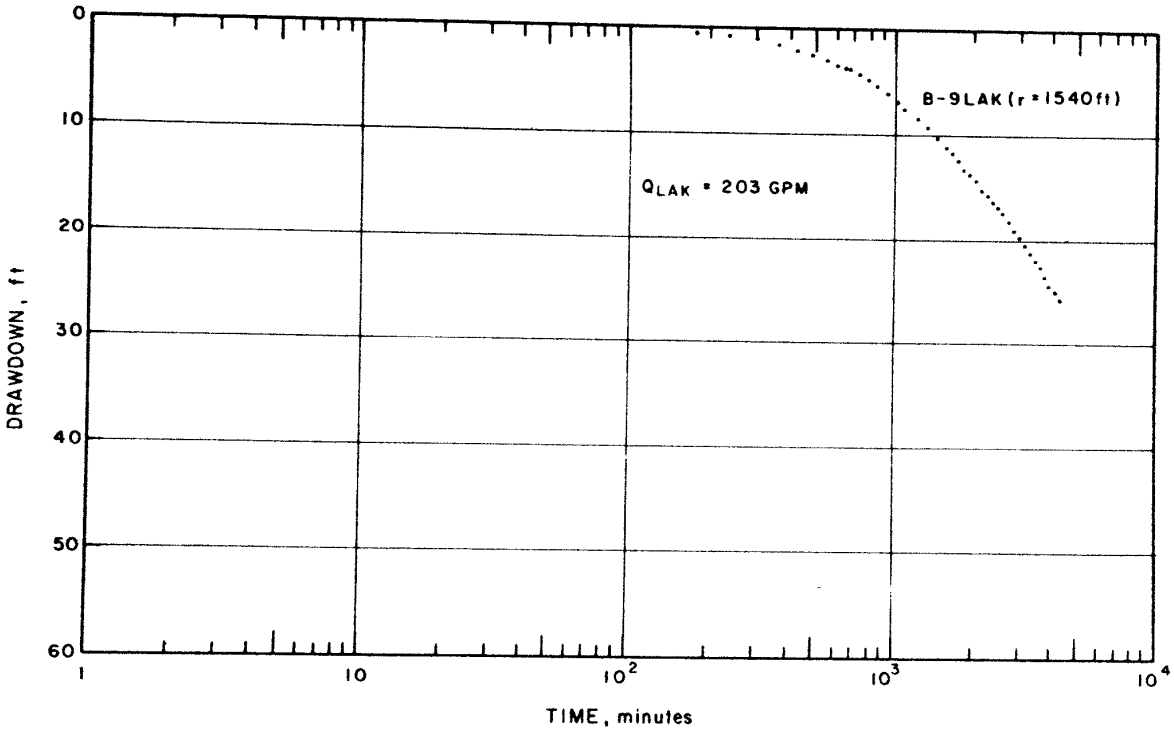

Figure II: Semilogarithmic Graph of Drawdown for B-9 Observation Well Group, Lakota Aquifer Test

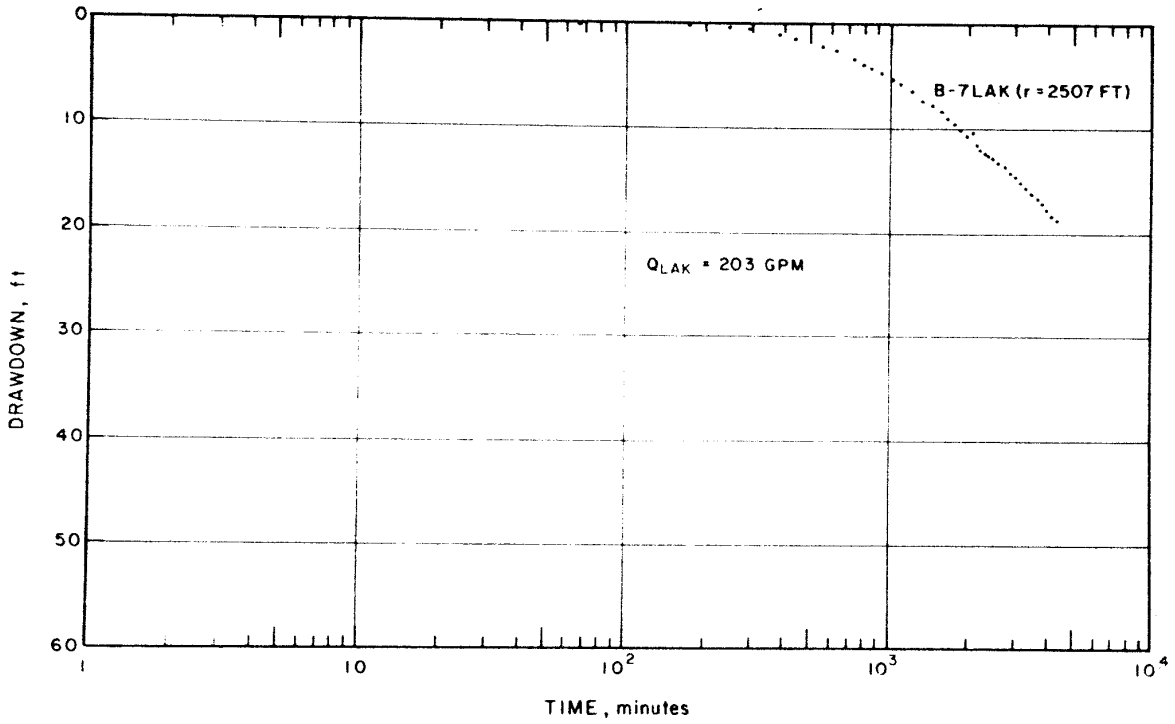

Figure 12: Semilogarithmic Graph of Drawdown for B-7 Observation Well Group, Lakota Aquifer Test

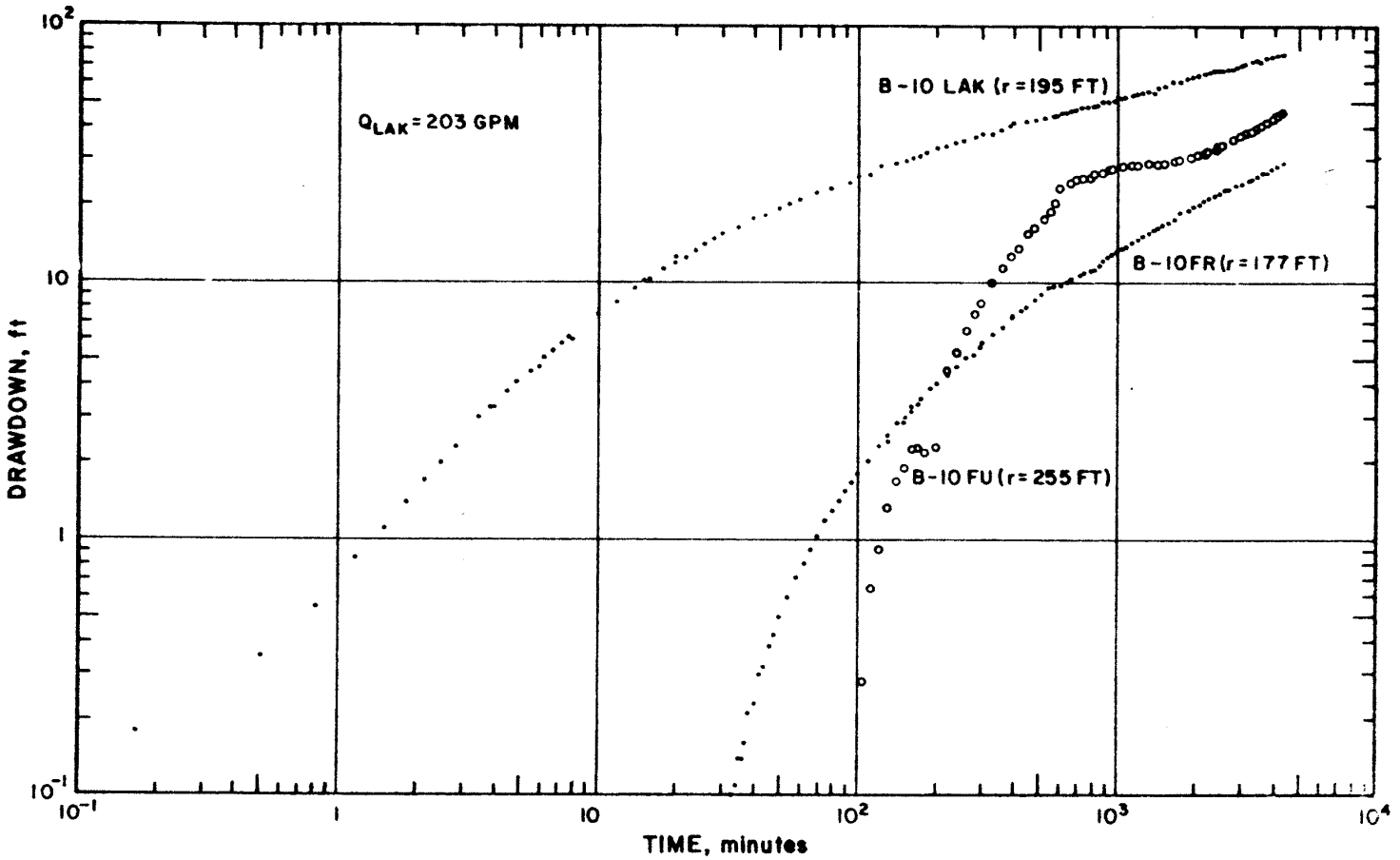

Figure 13 : Logarithmic Graphs of Drawdown for B-10 Observation Well Group, Lakota Aquifer Test

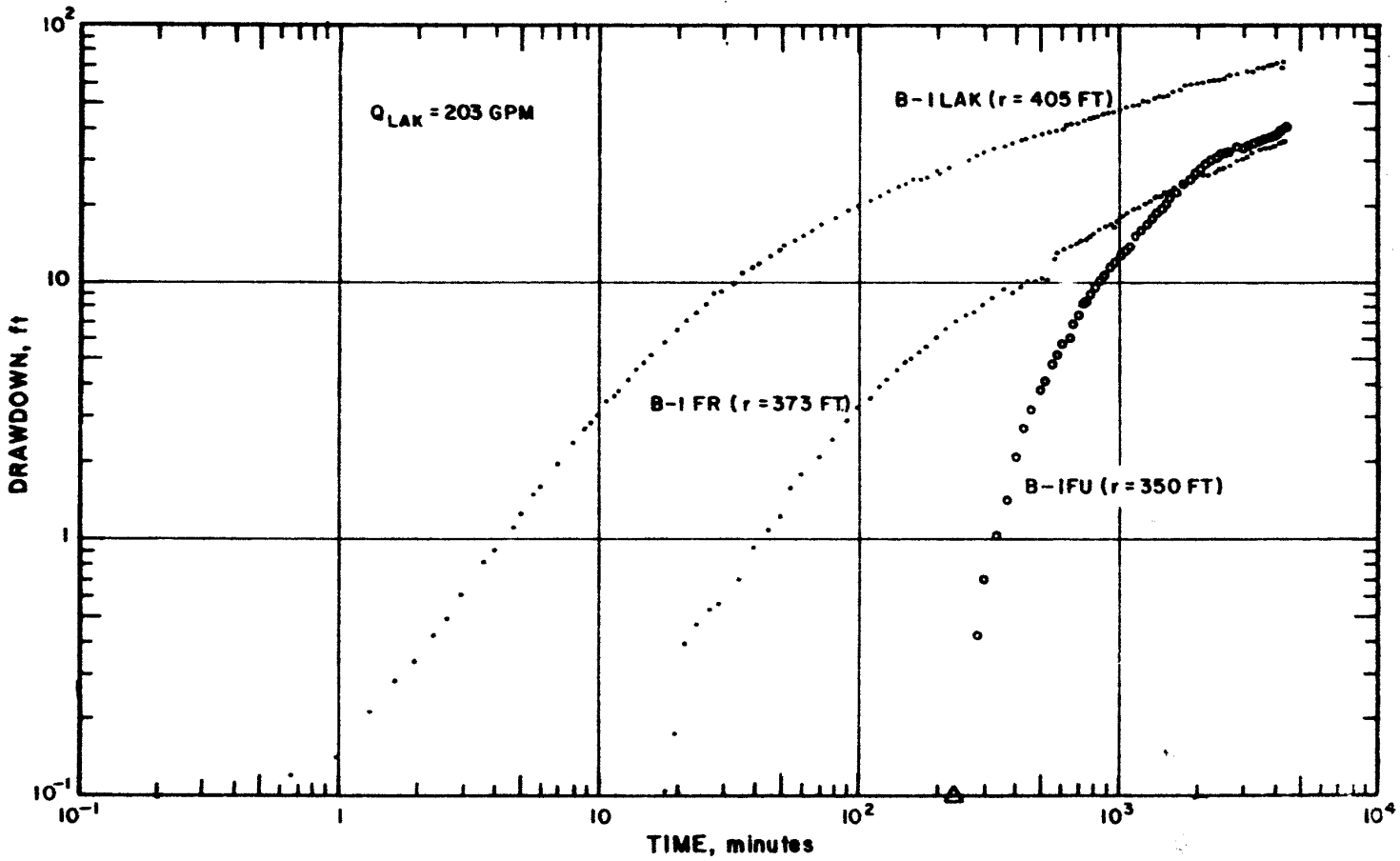

Figure 14 : Logarithmic Graphs of Drawdown for B-1 Observation Well Group, Lakota Aquifer Test

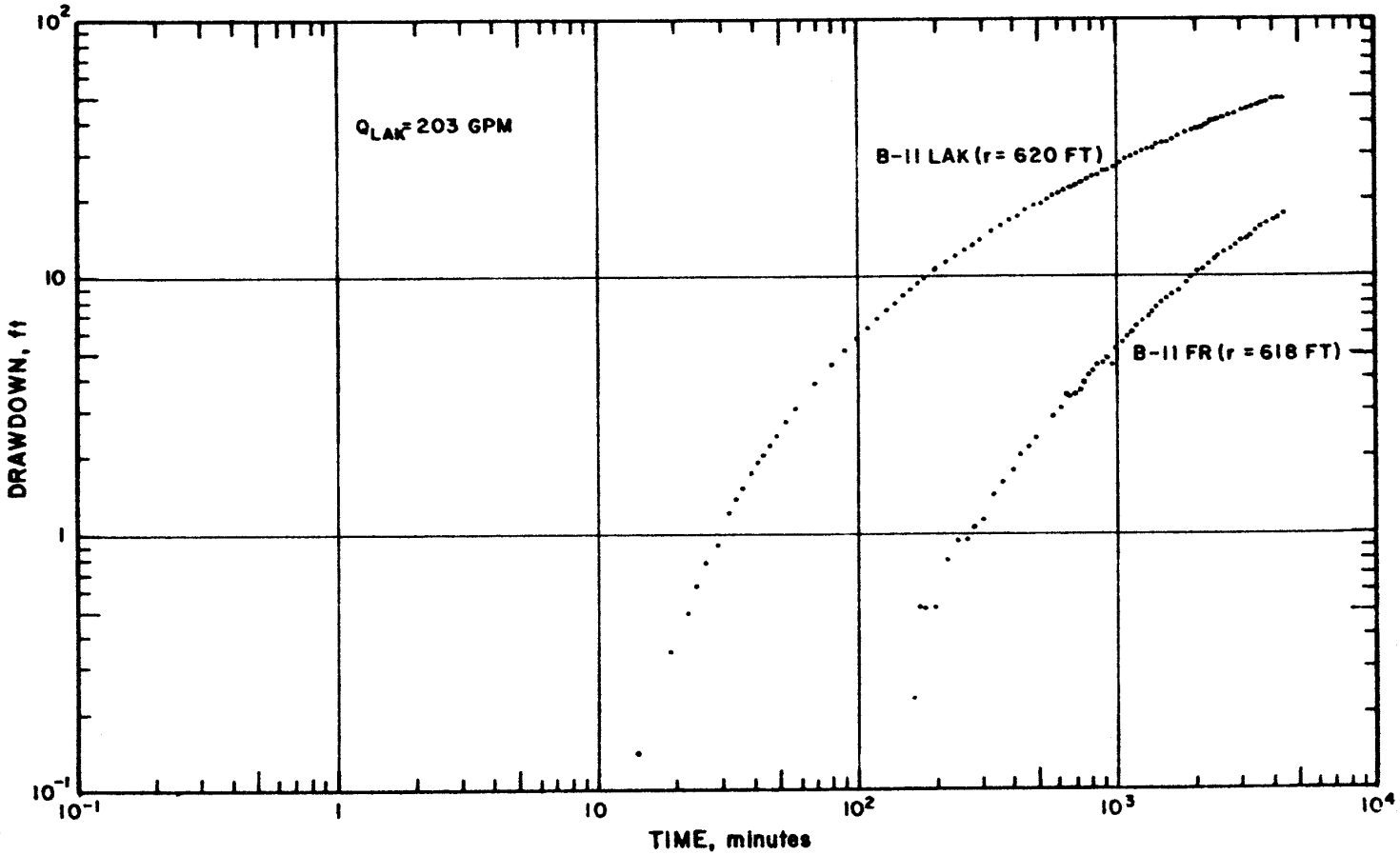

Figure 15: Logarithmic Graphs of Drawdown for B-II Observation Well Group, Lakota Aquifer Test

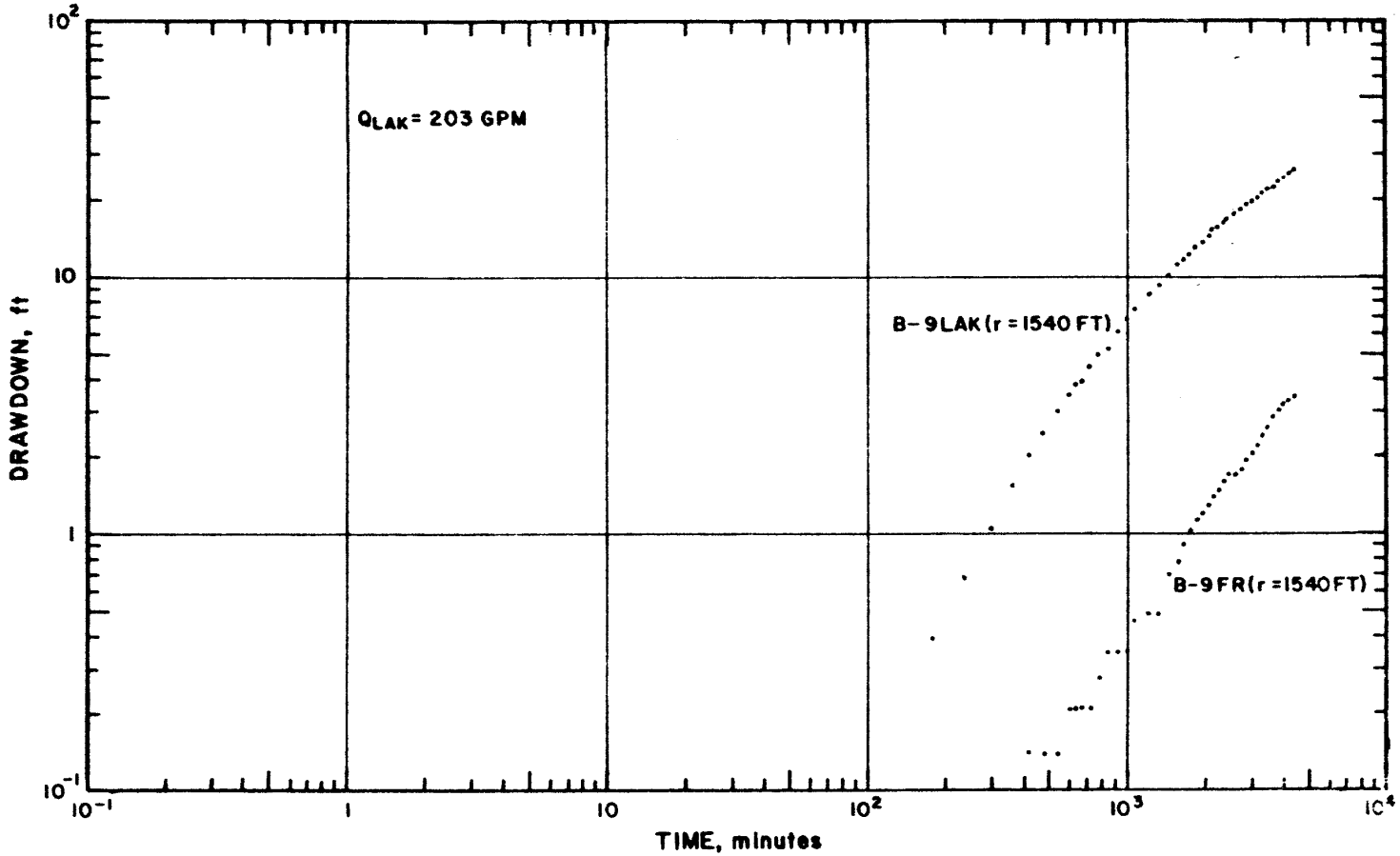

Figure 16 : Logarithmic Graphs of Drawdown for B-9 Observation Well Group, Lakota Aquifer Test

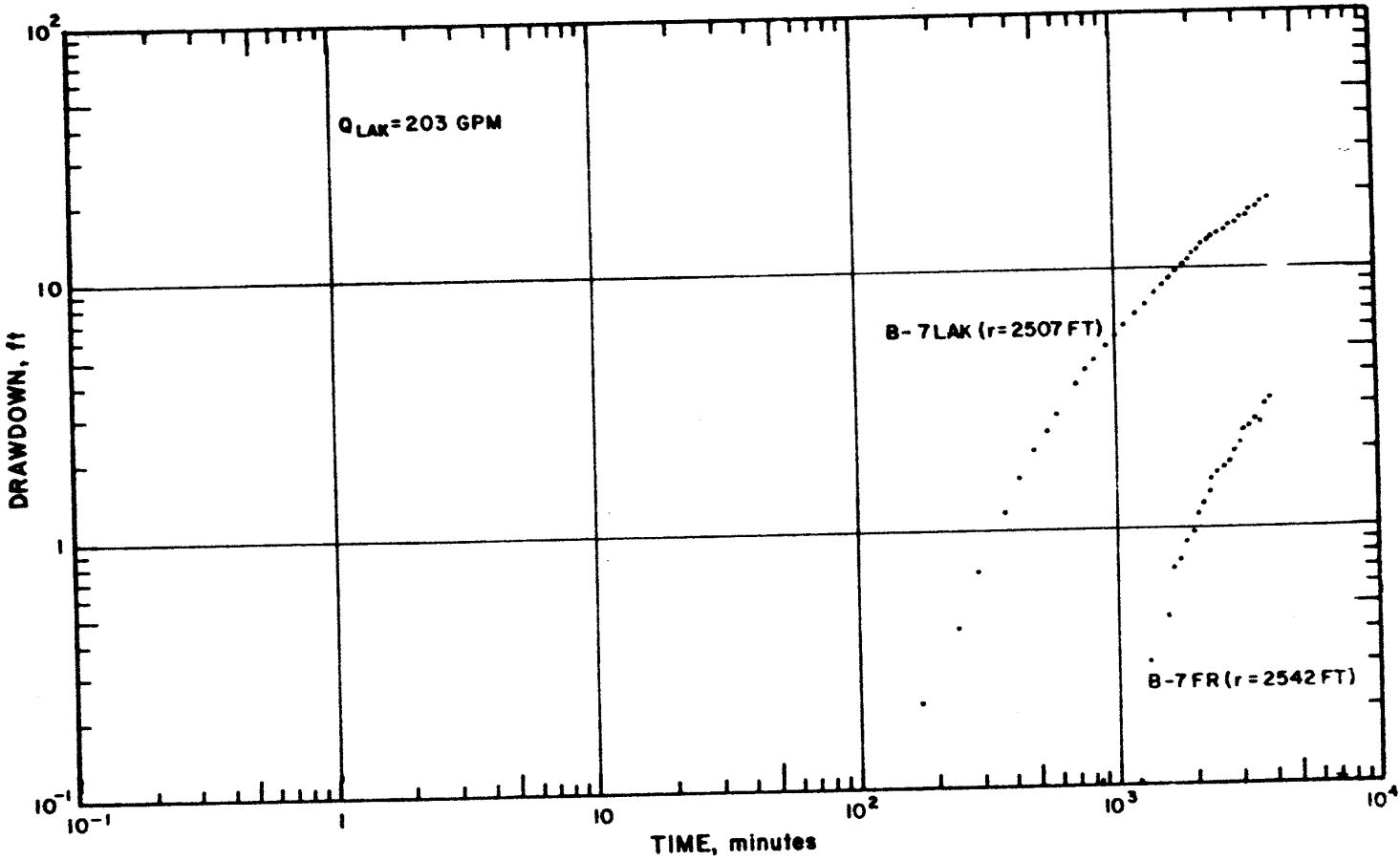

Figure 17 : Logarithmic Graphs of Drawdown for B-7 Observation Well Group, Lakota Aquifer Test

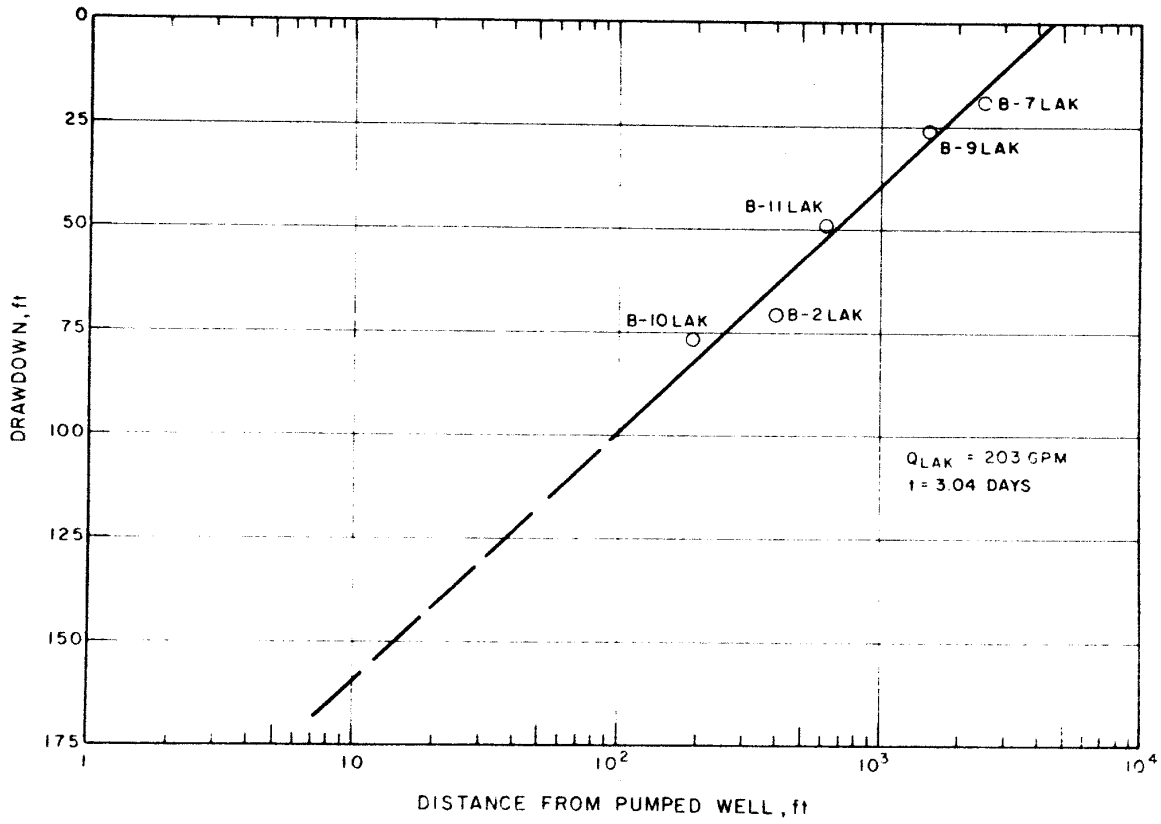

Figure 18 : Semilogarithmic Graph of Distance vs. Drawdown at End of Pumping Test, Lakota Aquifer Test

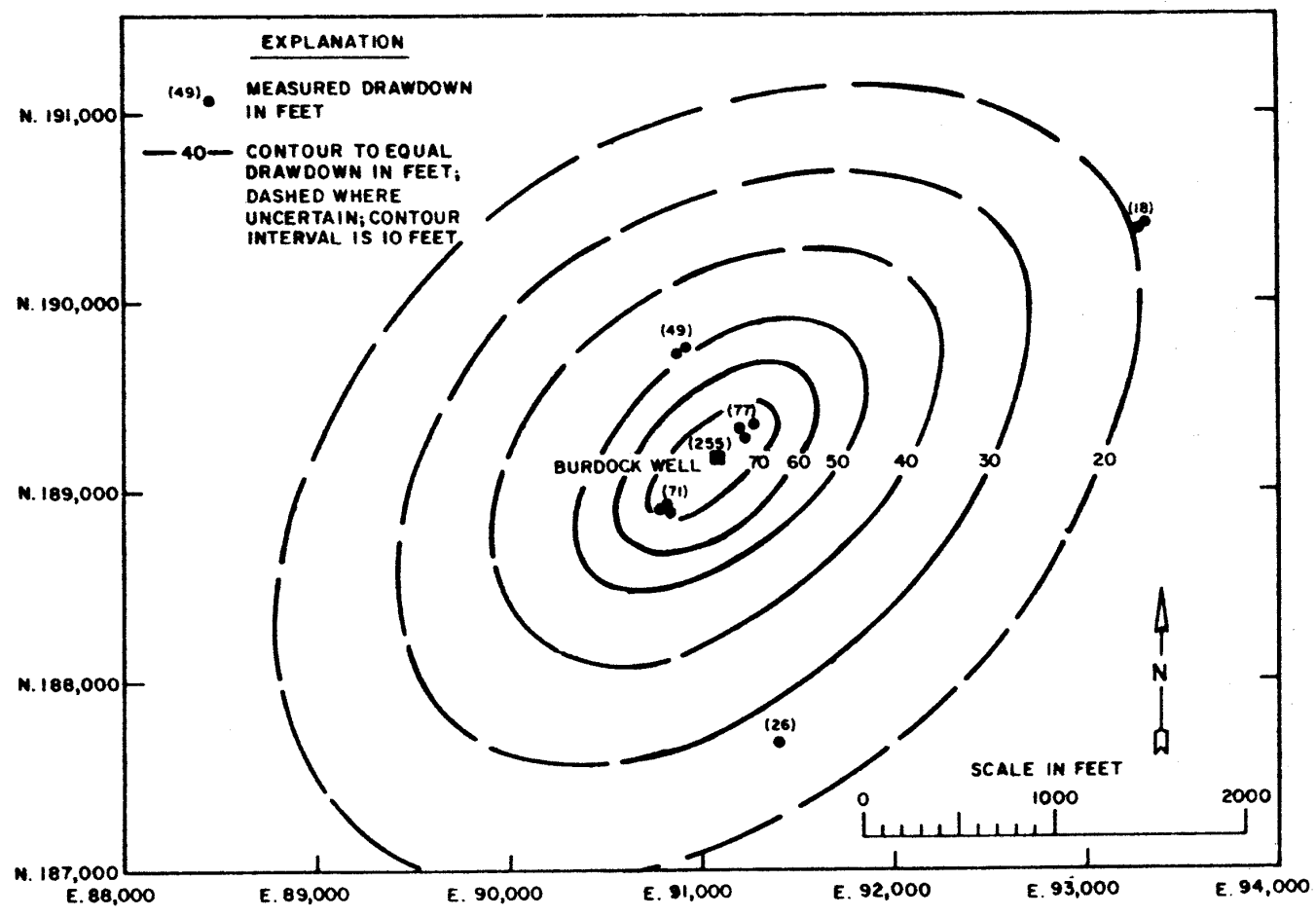

Figure 19 : Drawdown in Lakota Aquifer at End of Lakota Test

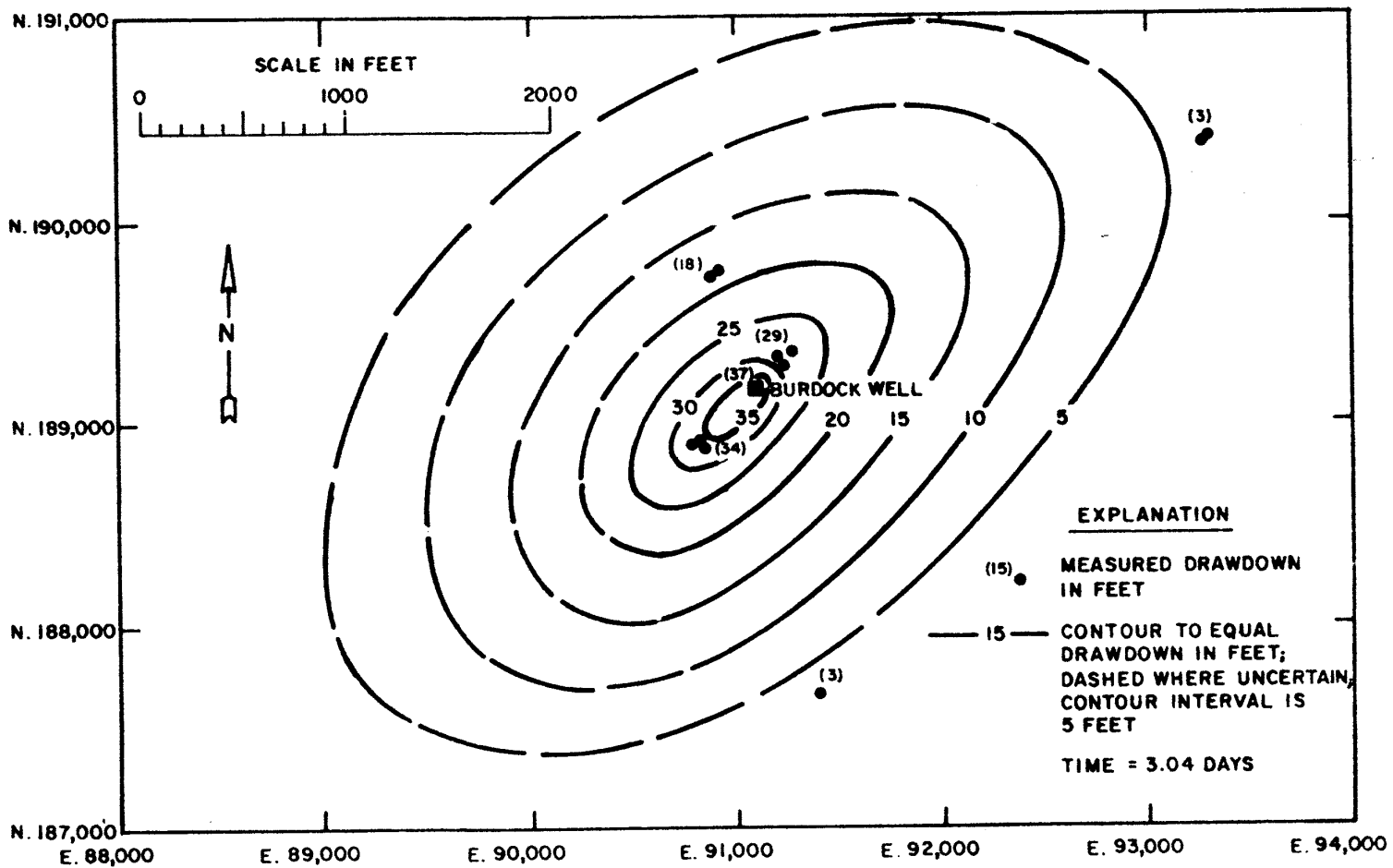

Figure 20 : Drawdown in Fall River Aquifer at End of Lakota Test

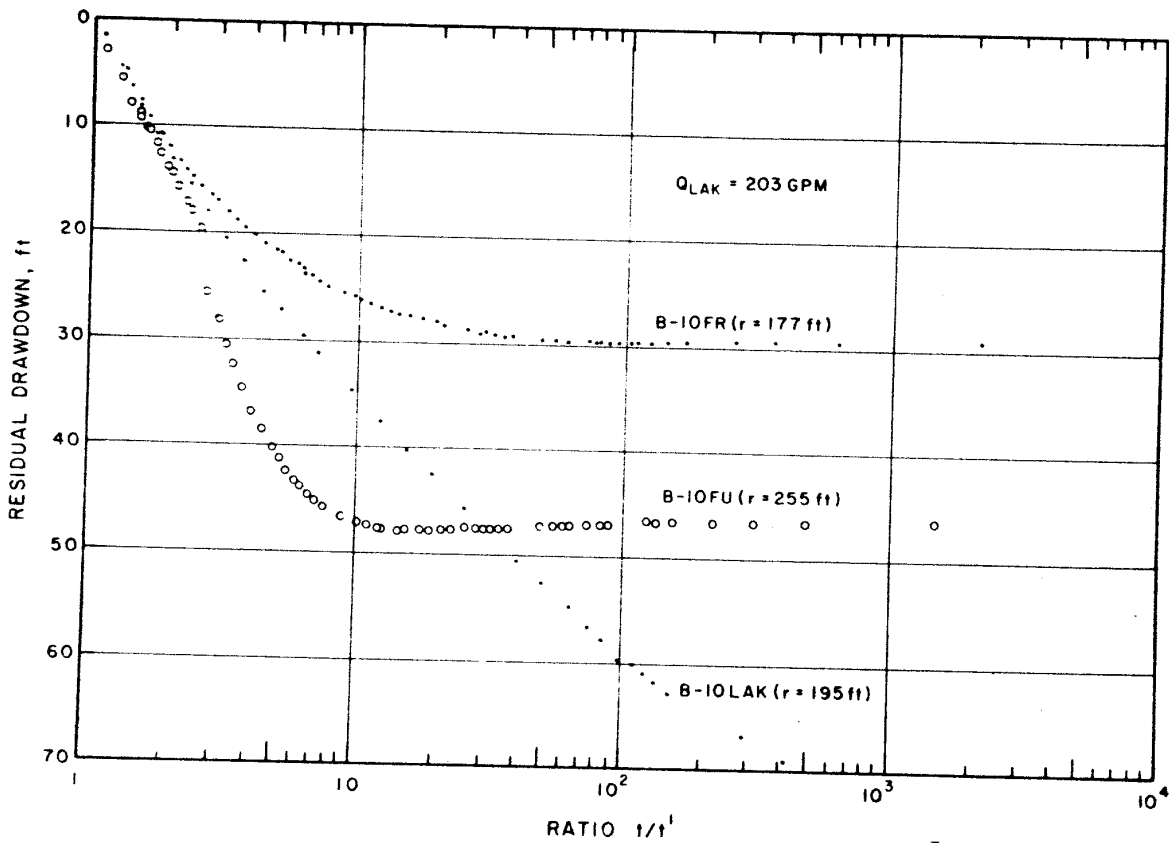

Figure 21: Recovery Graphs for B-10 Observation Well Group, Lakota Aquifer Test

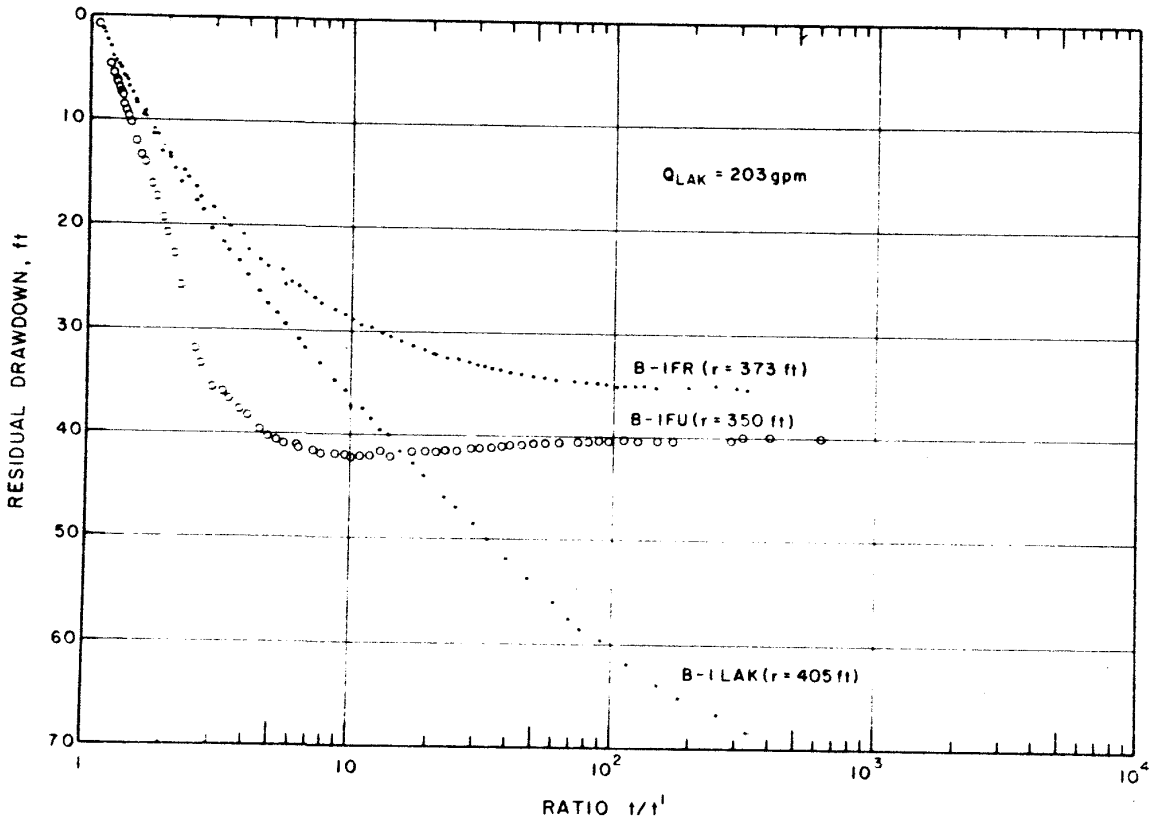

Figure 22: Recovery Graphs for B-1 Observation Well Group, Lakota Aquifer Test

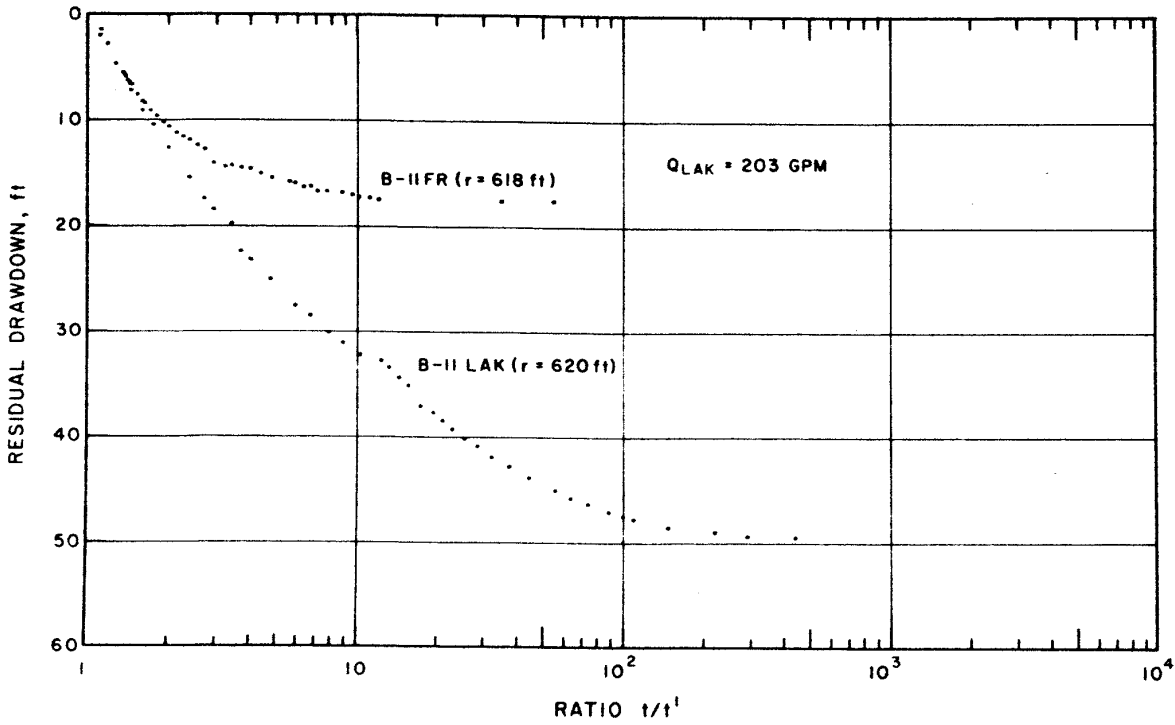

Figure 23: Recovery Graphs for B-II Observation Well Group, Lakota Aquifer Test

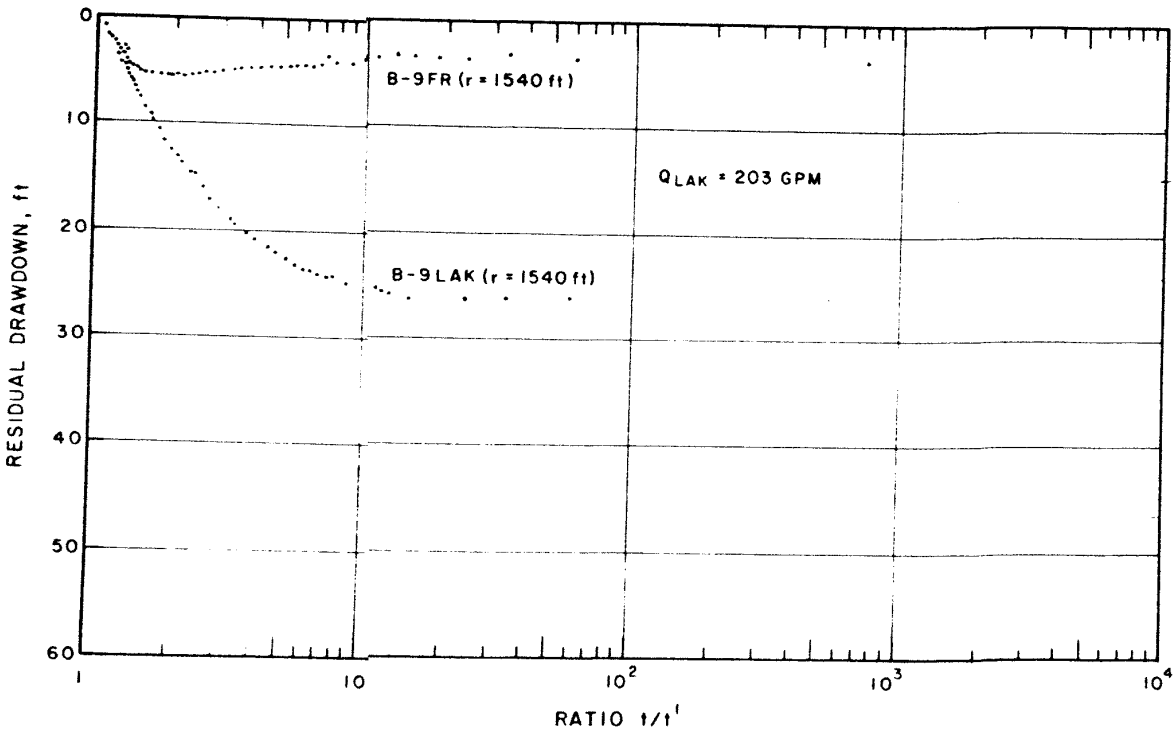

Figure 24 Recovery Graphs for B-9 Observation Well Group, Lakota Aquifer Test

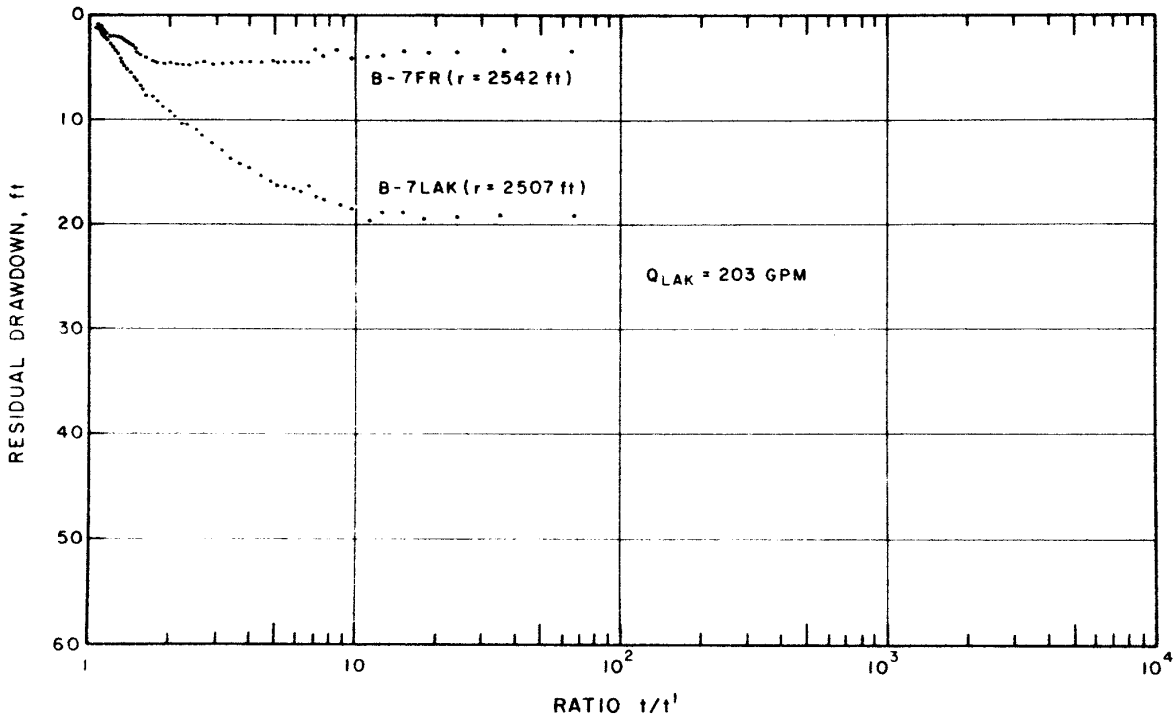

Figure 25: Recovery Graphs for B-7 Observation Well Group, Lakota Aquifer Test

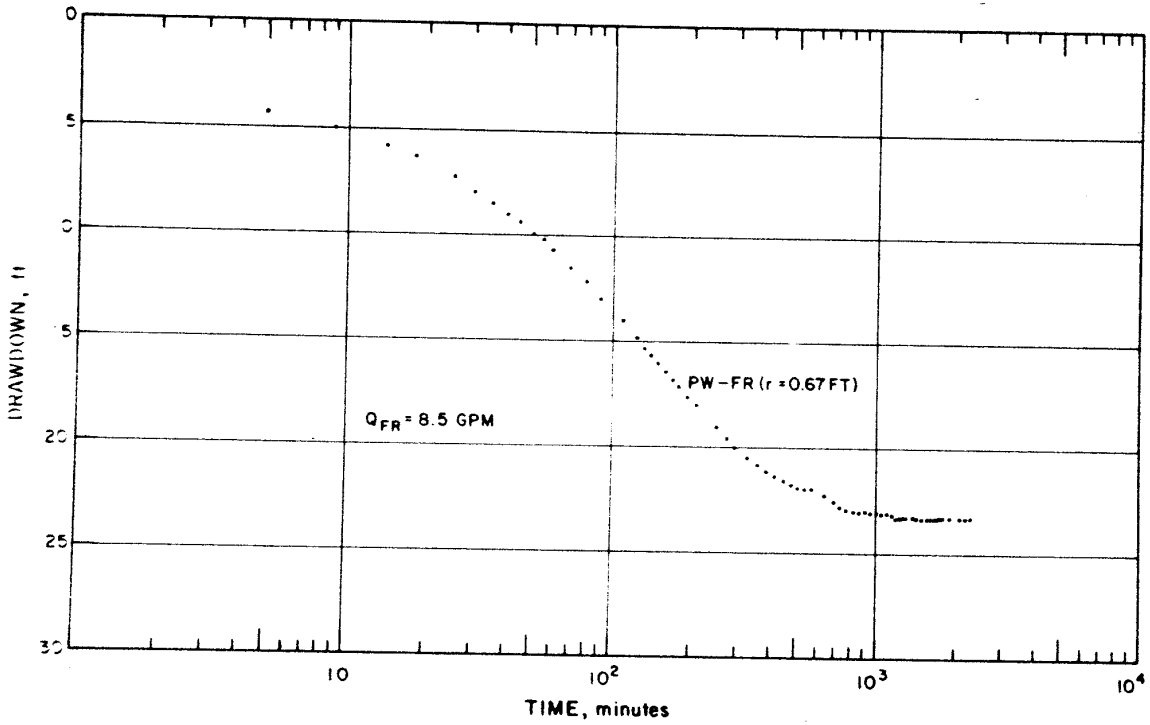

Figure 26: Semilogarithmic Graph of Drawdown for the Pumped Well, Fall River Aquifer Test

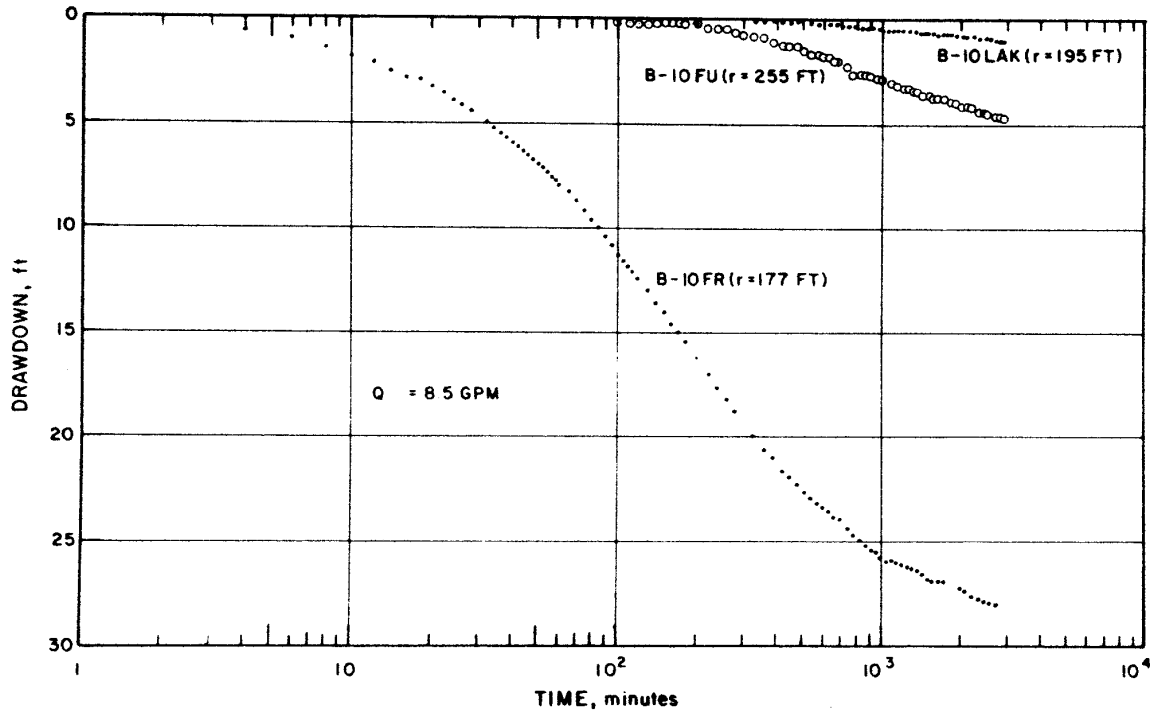

Figure 27: Semilogarithmic Graphs of Drawdown for B-10 Observation Well Group, Fall River Aquifer Test

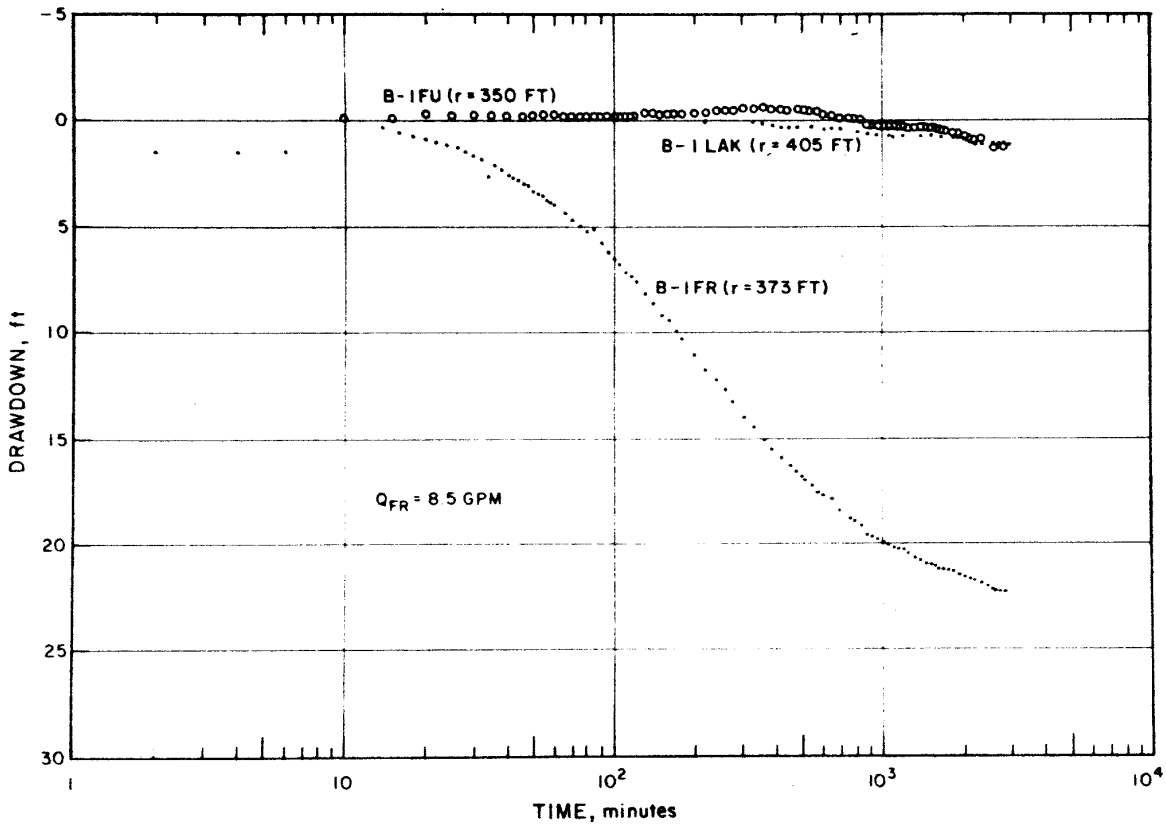

Figure 28 : Semilogarithmic Graphs of Drawdown for B-I Observation Well Group, Fall River Aquifer Test

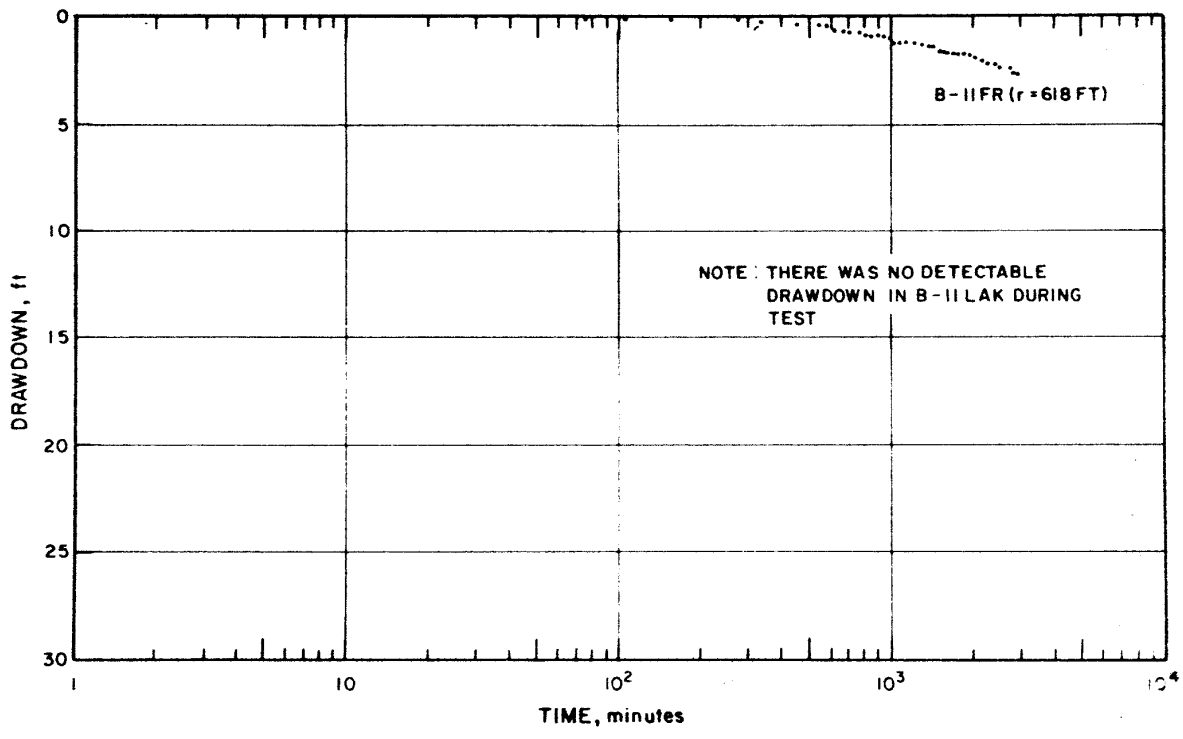

Figure 29: Semilogarithmic Graph of Drawdown for B-II Observation Well Group, Fall River Aquifer Test

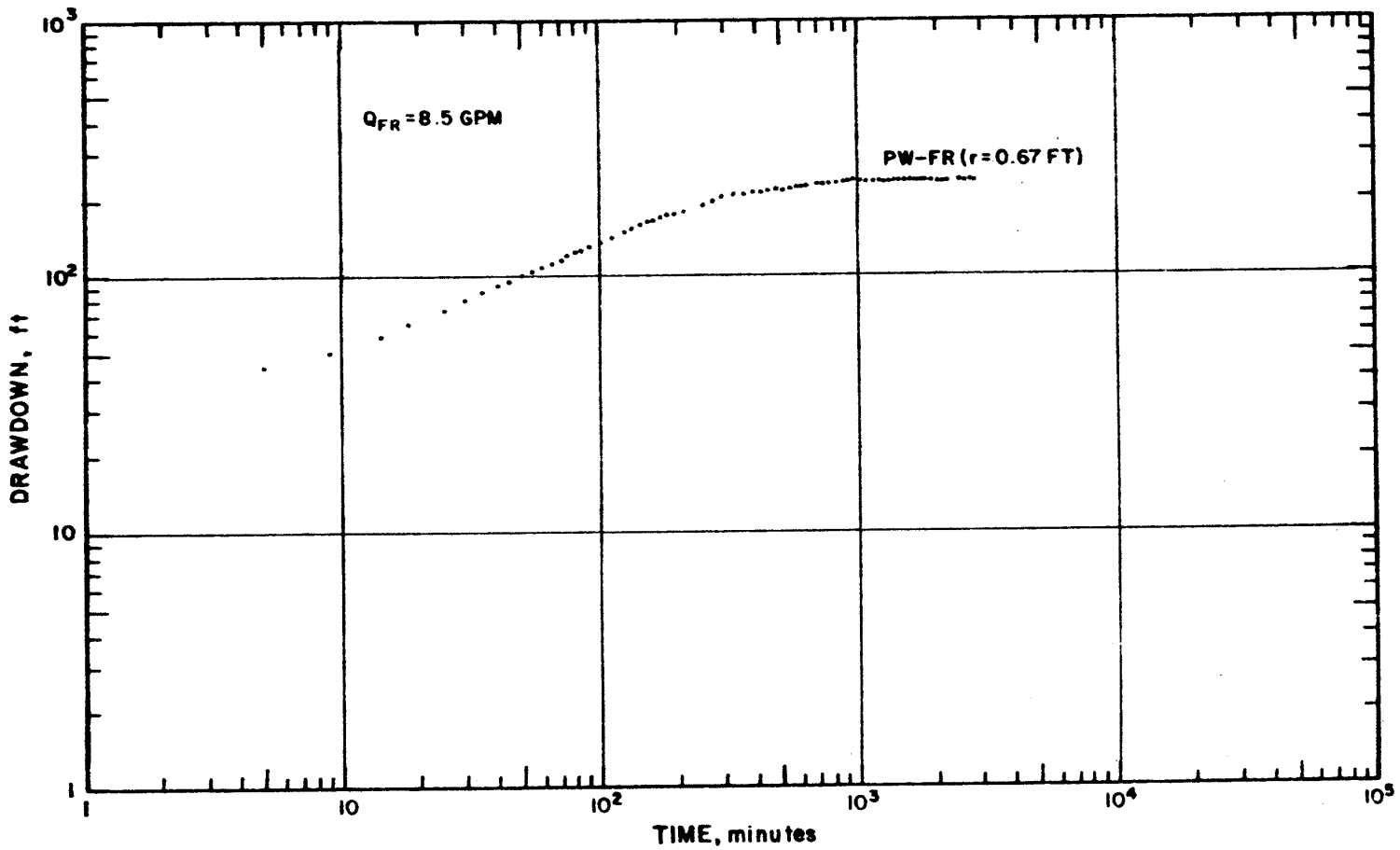

Figure 30: Logarithmic Graph of Drawdown for Pumped Well, Fall River Aquifer Test

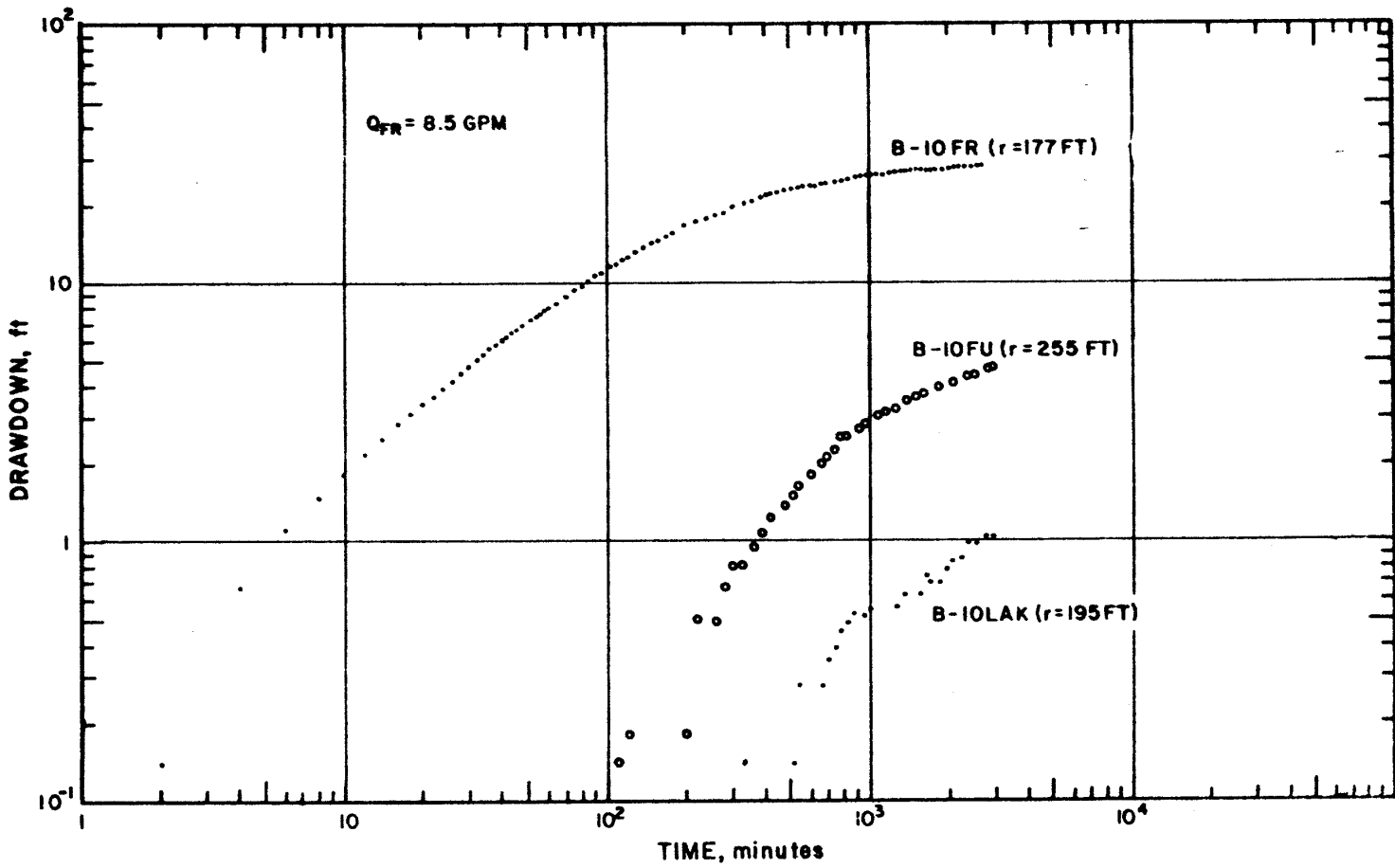

Figure 31: Logarithmic Graphs of Drawdown for B-10 Observation Well Group, Fall River Aquifer Test

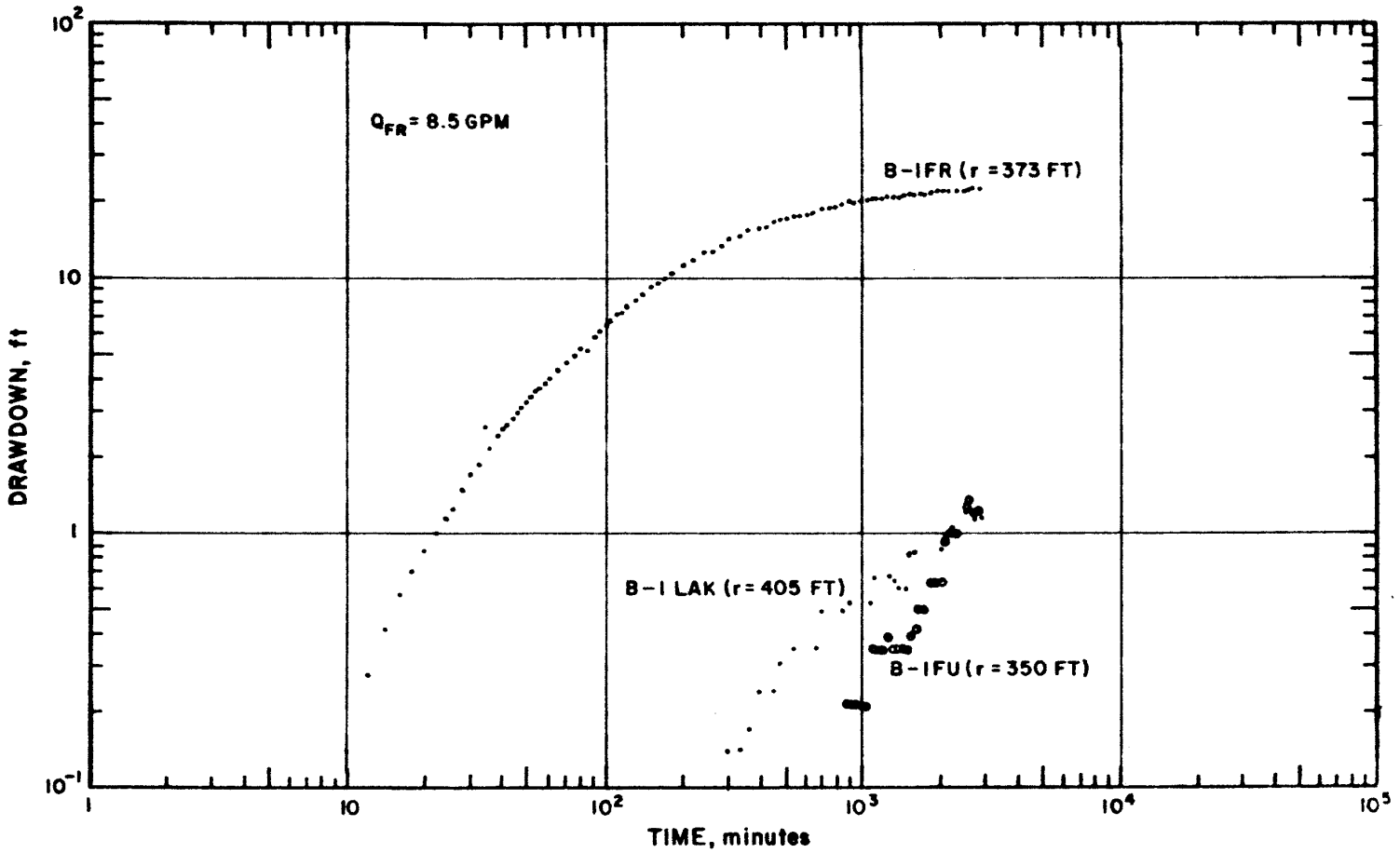

Figure 32: Logarithmic Graphs of Drawdown for B-I Observation Well Group, Fall River Aquifer Test

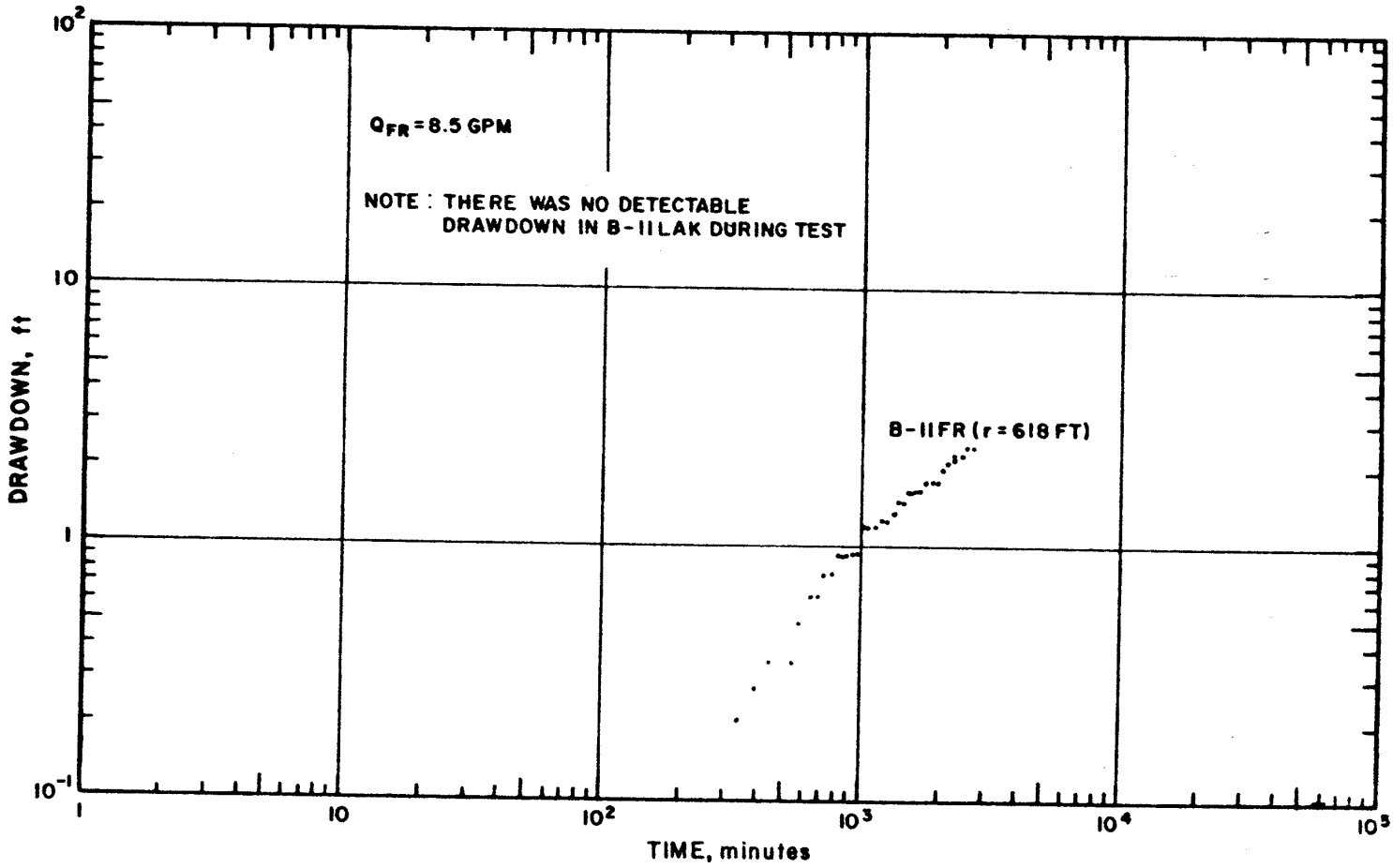

Figure 33: Logarithmic Graphs of Drawdown for B-II Observation Well Group, Fall River Aquifer Test

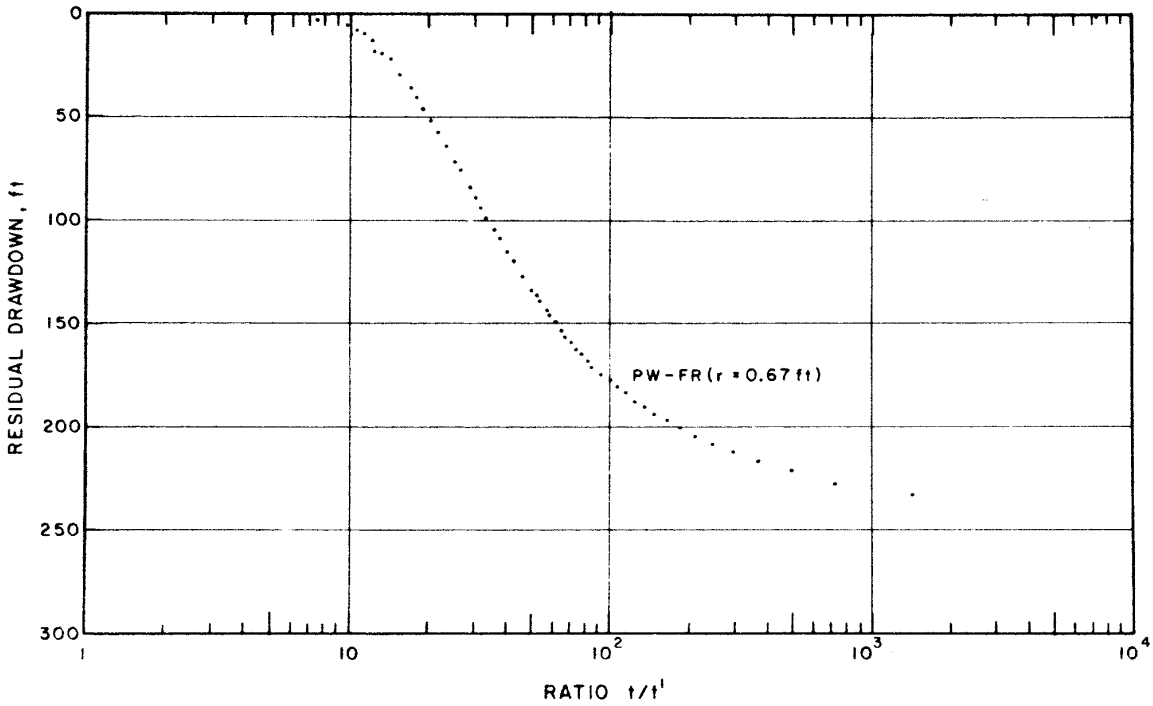

Figure 34: Recovery Graph for Pumped Well, Fall River Aquifer Test

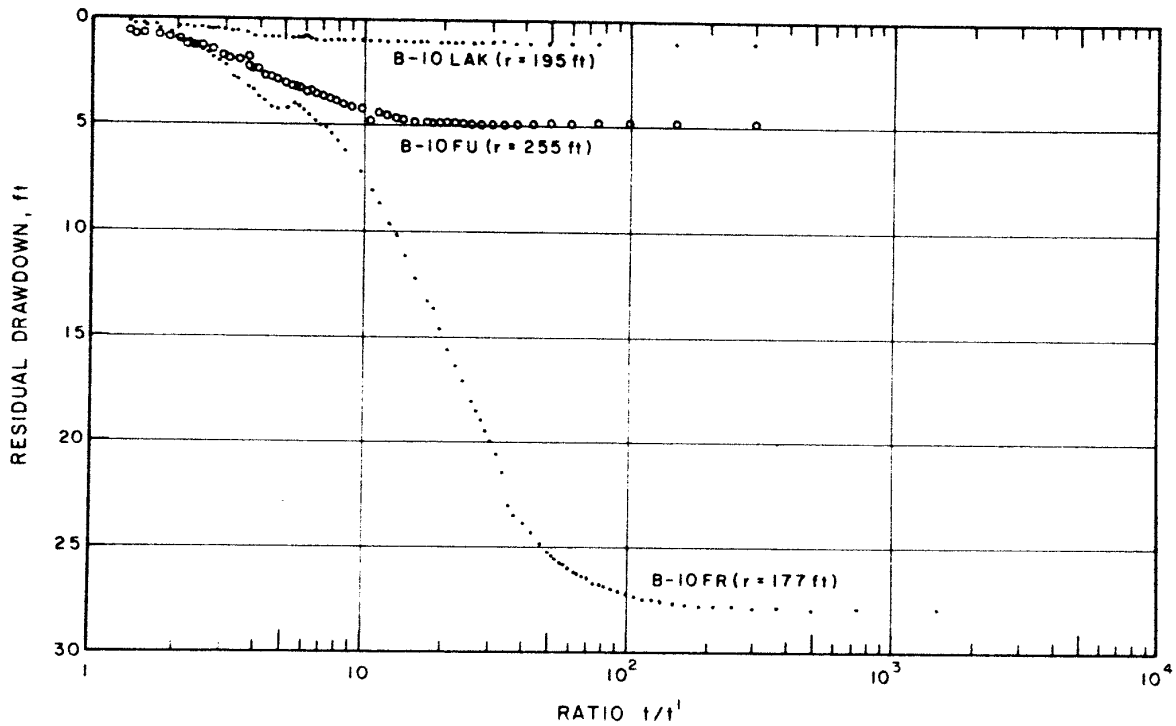

Figure 35: Recovery Graphs for B-10 Observation Well Group, Fall River Aquifer Test

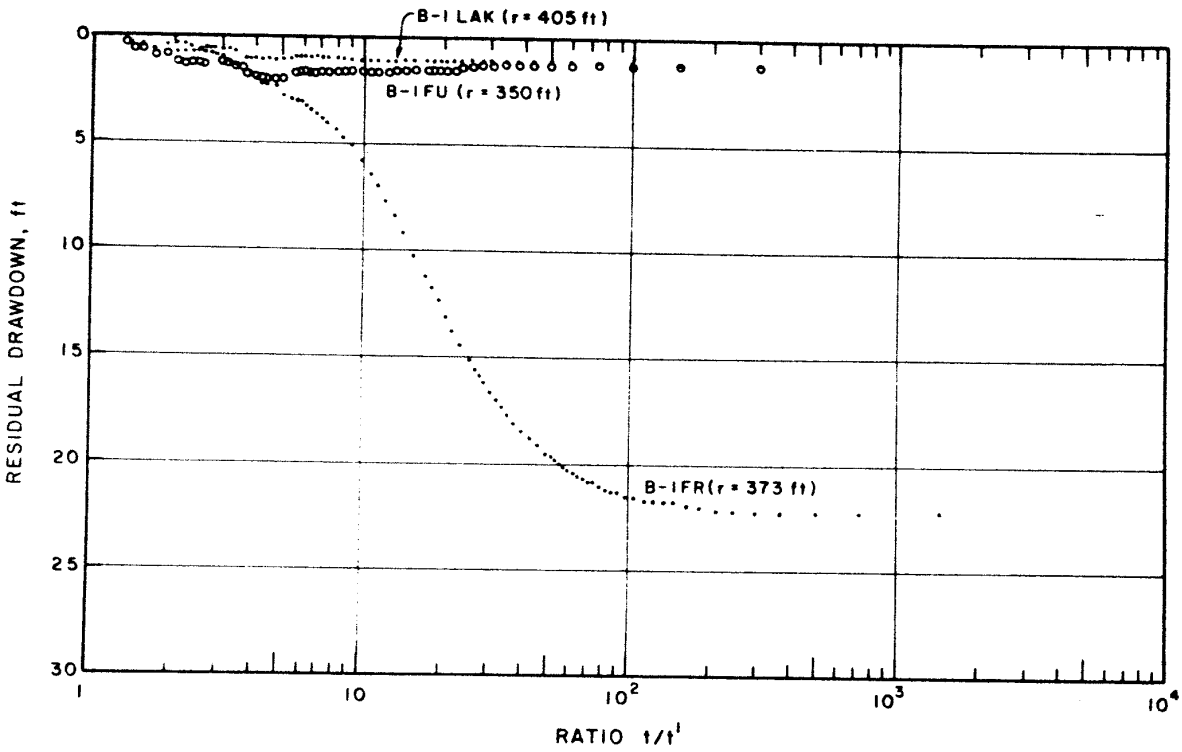

Figure 36: Recovery Graphs for B-1 Observation Well Group, Fall River Aquifer Test

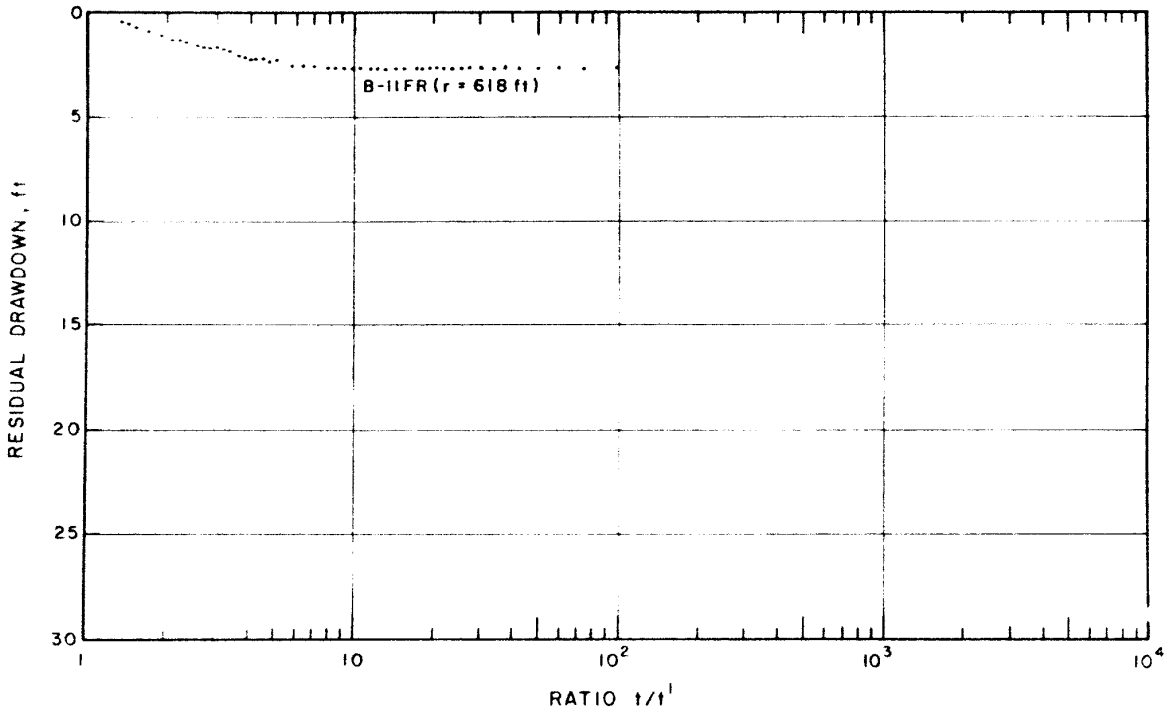

Figure 37 Recovery Graph for B-II Observation Well Group, Fall River Aquifer Test

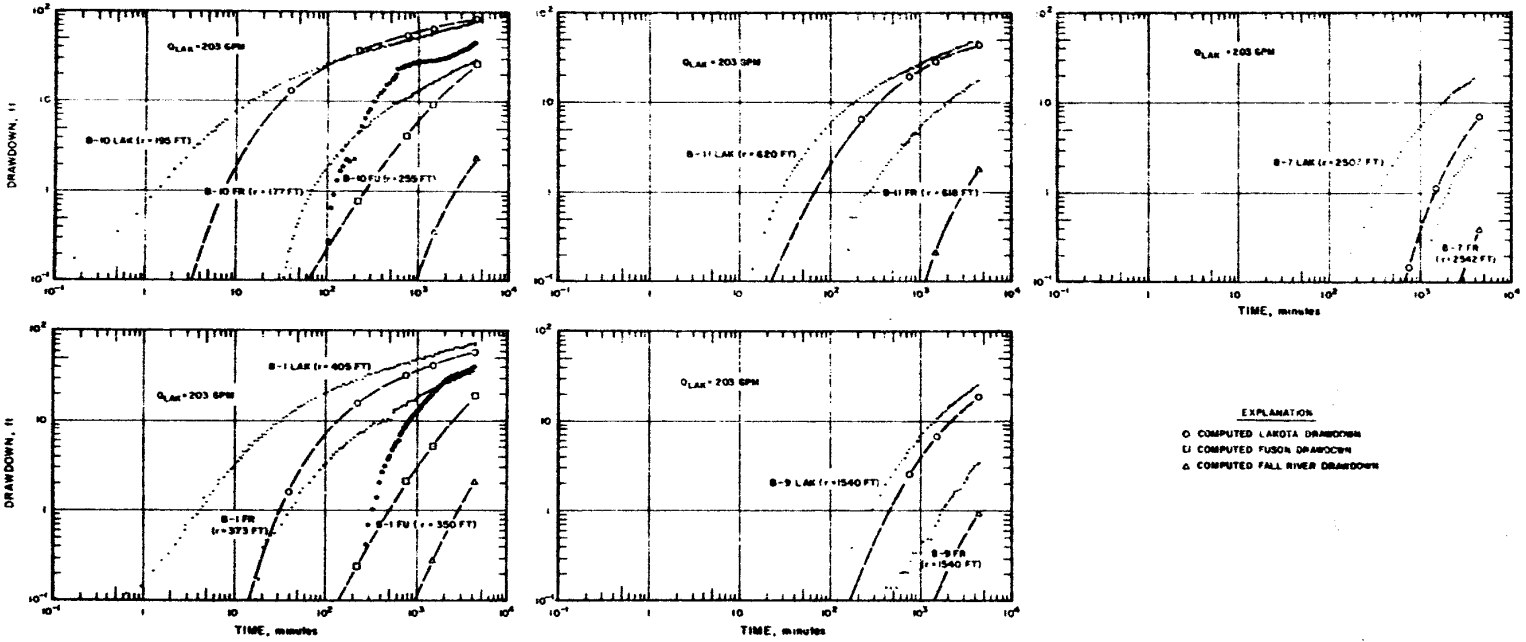

Figure 38 : Results of Initial Lakota Aquifer Test Simulation

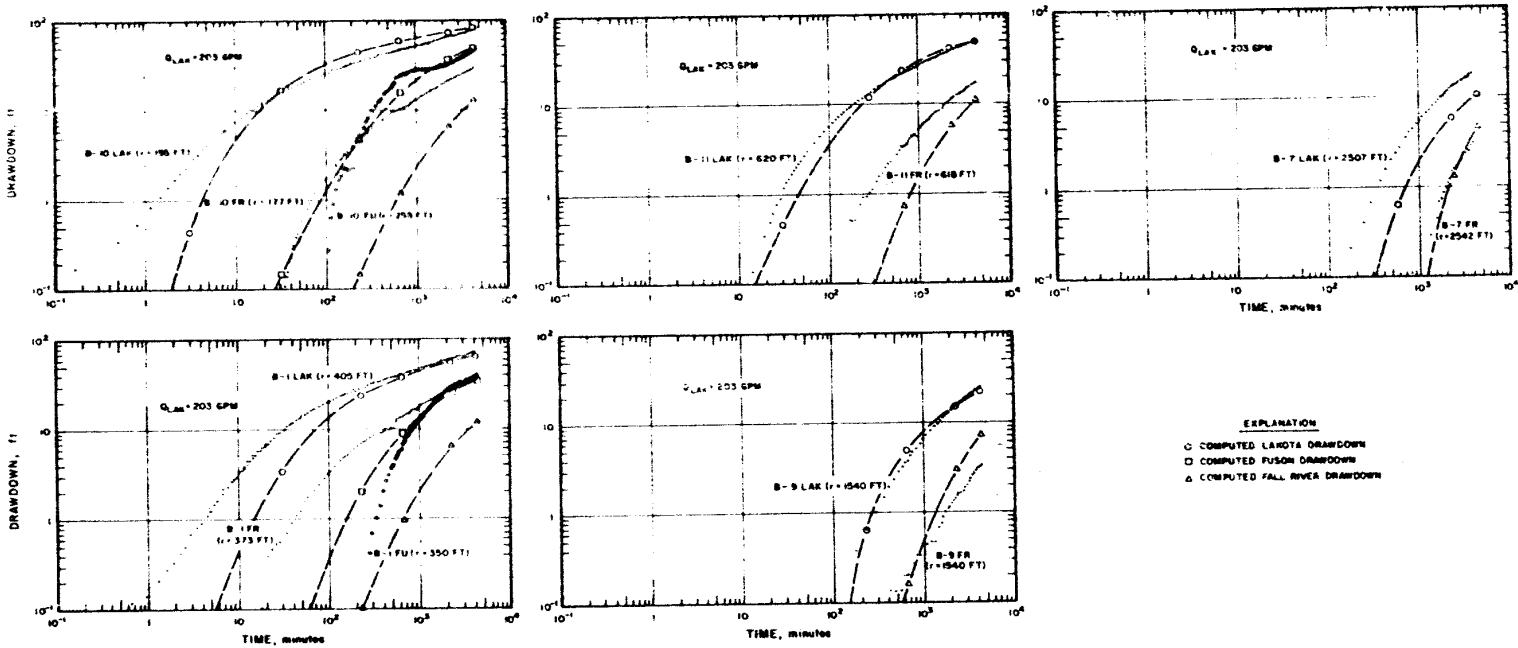

Figure 39 : Results of Final Lakota Aquifer Test Simulation

SOURCE P

HYDRO ID 704 RECOMPLETION

(Email from Len Eakin, Powertech (USA) Inc., to Mike Beshore, Powertech (USA) Inc., May 9, 2011)

This page intentionally left blank



POWERTECH (USA) INC.

Elizabeth Scheinost

From: Leonard Eakin [leakin@powertechuranium.com]
Sent: Monday, May 09, 2011 4:44 PM
To: Michael Beshore; Frank Lichnovsky; leakin@powertechuranium.com
Cc: escheinost@powertechuranium.com
Subject: re: Putnam Water Well 704
Attachments: _Certification_.htm

For DB08-5-1 the Unkpapa completion date was 4/29/2008. The Unkpapa was cemented off on 1/28/2009 and the Lakota was perf'd by Goodwell on 2/4/2009.

From: "Michael Beshore" <mbeshore@powertechuranium.com>
Sent: Monday, May 09, 2011 4:35 PM
To: "Frank Lichnovsky" <flichnovsky@powertechuranium.com>, leakin@powertechuranium.com
Subject: Putnam Water Well 704

Gents, Could Lisa and myself be provided the following information on well 704. This was the Putnam well that was originally drilled to the Unkpapa, and then cemented up to the Lakota.

Please Provide:
Date Drilled to Unkpapa and the Date Cemented up to the Lakota.

This may have occurred on the same day, but need to make certain so we know what water quality samples are from what.

Thanks, Mike



POWERTECH (USA) INC.

Michael D. Beshore, P.G.
Senior Environmental Coordinator

Powertech (USA) Inc.
P.O. Box 1066
8305 6th Street
Wellington, CO 80549
(970) 282-7777 office
(970) 556-5988 cell
Email: mbeshore@powertechuranium.com
Website: www.powertechuranium.com

This communication may contain information that is legally privileged, confidential or exempt from disclosure. If you are not the intended recipient, please note that any dissemination, distribution or copying of this communication is strictly prohibited. Anyone who receives this message in error should notify the sender immediately by telephone or by return e-mail and delete it from their computer.

This page intentionally left blank

SOURCE Q
SOUTH DAKOTA WATER RIGHT 380-2

This page intentionally left blank

380-2

No.

**Office of State Engineer
DOCUMENT FILE**

Darrel Hawthorne

Custer

Ground Water Supply

Well No. 2

NW 1/4 NW 1/4 Sec. 17-6 S-1 E

Custer County

Map No. 409-2

No. 380-2

Division No. 2

Fall River District

PERMIT

to appropriate water from

Ground Water Supply

Custer County, South Dakota.

Name of applicant

Darrel Hawthorne

Name of diversion works Golden

Cliff Irrigation Project Div. No. 2

Date of first receipt at office of State

Engineer June 29 1951

Returned to applicant for Correction

..... 19.....

Corrected application received

..... 19.....

Date of water right

June 29 1951

Recorded in Book 3 *Series 4* Part 4

One-fifth of work to be completed

Sept. 12 1952

Whole work to be completed

Sept. 12 1953

Final proof of use of water

Sept. 12 1953

Approved Sept. 12 1951

DEAR ... LOUCKS State Engineer.



Hydro ID 710

Map No. 109-2

2 of 11

Form 203-Supplement for Permit to appropriate Water--Original Ground Water H. P. Co. 4356

NO. 380-2

Water Division No. 2 Fall River (Blanks to be filled by the State Engineer.)

RECEIVED District 4: P.M. JUN 20 1976

APPLICATION FOR PERMIT To appropriate Water within the State of South Dakota OFFICE OF STATE ENGINEER S. DAK.

(NOTE--Draw a line through items not applicable.)

1. Name of applicant Harry C. Hallenbeck Postoffice address Star Route, Edgemont 57435, County DeSha, State S. Dak.

- I. If a corporation (a) Name of same (b) Date and place of incorporation (c) Amount of capital stock (d) Amount paid in (e) Names and address of directors

(NOTE--A certified copy of articles of incorporation must accompany the application.)

- II. Method of accomplishing the work and financial resources of the applicant: (a) Method of accomplishing work (b) Cash on hand \$5076.00 (c) Treasury stock \$none (d) Bonds to be issued \$none (e) Other resources \$

2. Name of well Golden Cliff Irrigation Project Well No. 2
3. Quantity of water claimed 300 gal. per min.
4. Source of water supply (estimated depth) 276
5. Location of well (subdivision) 1/4 Sec. 17, T. 6, S. 3, R. 1, E.
6. Annual periods during which water is to be used April 1 to Oct. 1
7. To be used for:

- I. Irrigation or domestic use: Gravity, overhead sprinkling or combination system? (a) Number of acres to be irrigated 126.49 acres (b) Legal subdivisions to be irrigated Sec. 17, Attached (c) Statement as to domestic use (giving location, etc.) none

(NOTE--A list of lands to be irrigated, giving each subdivision and fraction with acreage thereof, should be written here, or may be appended as a part of this application. Same must also be shown on accompanying map.)

- II. Stockwatering, mining, milling, power, fish culture, fire protection and public recreation: (a) Nature of use none (b) Amount of power to be generated horse power (c) Location of plant (d) Method of developing power (e) Point where return water will be diverted to stream



Hydro ID 710

3 of 11

8. Estimated cost of works:

- (a) Head gate, \$.....
- (b) Pumping plant, \$ 2000.00
- (c) Flaming, \$.....
- (d) Canal-earth, \$.....
- Rock, \$.....
- (e) Other structures Pipe, \$5000.00
- \$ 8000.00
- Total, \$ 10000.00

9. Description of works:

(a) Head gate: Width feet; height feet; Material

(b) Log of well:

(To be completed when well is drilled)

TO FEET	FROM	LOG OF WELL
0	40	Shale and Top Soil
40	50	Dakota Sand
90	5	Fuson Formation
96	370	Lakota Sand
370	37	Merriam Formation

(c) Measuring device Pressure Gauge and Nozzle Size

(d) Canal: Total length None miles.

LOCATION BELOW HEADGATE	DEPTH	BOTTOM WIDTH	WIDTH AT STATE LINE	GRADE PER MILE
At Mile feet feet feet feet
At Mile feet feet feet feet
At Mile feet feet feet feet
At Mile feet feet feet feet
At Mile feet feet feet feet
At Mile feet feet feet feet

(Give dimensions where reductions in size are made.)

(e) Was water tested for irrigation purpose?

Result: Excellent

10. Time required for completion of work 2 years.

11. Time required for complete application of water to the proposed beneficial use 1 1/2 years.

12. Choice of newspaper for publication of notice of intention to appropriate Customer Chronicle, Casper, S.Dak.

STATE OF SOUTH DAKOTA

County of Casper

I, Daniel Hawthorne, being first duly sworn on my oath depose and say: That my relation to the above described, undertaking is that of owner, that I have read the above and foregoing statement, and examined the map accompanying the same, and that I know of my own personal knowledge that the matters herein stated and shown, are true.

Signed Daniel Hawthorne

Subscribed and sworn to before me this 22 day of June, 1931

Edna F. Richardson Notary Public (or other qualified officer.)



Hydro ID 799
Form 799 by State Engineer:

STATE OF SOUTH DAKOTA

County of Hughes ss.
Pierre, South Dakota, Sept. 12, 1951, 1951

This is to certify that the foregoing application was received at this office at 4:00 o'clock
P. m. upon the 22nd day of June, 1951 and that after examination it
was found to comply with the South Dakota water laws, was published in accordance with the provisions
thereof and consideration given to any and all information presented ~~found to comply with the South~~
~~Dakota water laws, was published in accordance with the provisions thereof and con-~~
~~sideration given to any and all information presented.~~

~~NO PROTESTS WERE RECEIVED.~~

Walter Loucks
DEAN W. LOUCKS State Engineer.

Number of permit 340-2
Date of first receipt of application June 29, 1951
Date of return to applicant for correction , 19
Date of receipt of corrected application , 19
Date from which applicant may claim right June 29, 1951
Approved Sept. 12, 1951, Recorded in Book Page

This is to certify that I have examined the foregoing application for a permit to appropriate
water of the State of South Dakota, and I hereby grant the same as stated herein, subject, however,
to the following limitations and conditions:

- 1st. The equivalent of at least one-fifth, of the work above specified is to be completed on or
before Sept. 12, 1952.
- 2nd. The whole of said work is to be completed on or before Sept. 12, 1953.
- 3rd. The limit of time for proof of beneficial use of water appropriated in accordance herewith
is Sept. 12, 1953.
- 4th. The water appropriated shall be used for the purpose of Providing irrigation.
- 5th. The prior right of all persons who, by compliance with the laws of the State of South Da-
kota, have acquired a right to the use of water must not be injuriously affected by this appropriation.
- 6th. The amount of the appropriation herein granted shall not exceed 800
gallons per minute; neither shall it exceed the capacity of the above described system
of diversion works, nor the least amount of water that experience may hereafter indicate as neces-
sary for the production of crops in the exercise of the best husbandry; and further, said appropria-
tion must be limited to not more than one-seventieth (1/70) of one cubic foot of water per second of
time for each acre of land to which water is actually and beneficially applied for irrigation on or
before Sept. 12, 1953; said water to be used during the following described an-
nual period:

April 1 to October 1, Inclusive

Witness my hand this 12th day of Sept., 1951.

Walter Loucks
DEAN W. LOUCKS State Engineer.

Certificate of Construction issued SEPTEMBER 9, 1951
Water License issued SEPTEMBER 9, 1951



Location of Lands to be Irrigated by the Golden Cliff Irrigation Well No. 2.

Location	Sec.	Twp.	Rge.	Acres
N 1/4 M 1	17	6 S.	1 E.,	34.40
N 1/4 M 2	17	6 S.	1 E.,	5.07
S 1/4 M 1	17	6 S.	1 E.,	35.25
S 1/4 M 2	17	6 S.	1 E.,	38.30
N 1/4 T 1	18	6 S.	1 E.,	10.46
Total,				116.48

DISCHARGE OF ONE SPINNING HEAD - TWO NOZZLES - 7/32 & 1/4 "

Pressure in Pounds

Discharge in GPM.

25	14.8
30	16.2
35	17.6
40	18.9
45	20.1
50	21.2
55	22.4
60	23.4



STATE OF SOUTH DAKOTA

WATER LICENSE NO. 330-2

(1) WHEREAS, On the 29th day of June A. D. 19 51 Darrel Hawthorne

made Water Right Application No. 530-2 for a permit to use 1.70 cubic feet per second of the waters of artesian ground water

County of Custer State of South Dakota, for irrigation purposes; and

(2) WHEREAS, On the 12th day of September A. D. 19 51

Permit No. 380-2 with a date of priority of June 27, 1951

was issued to said applicant for the diversion of said water, and provided for the completion of construction of the water supply system therein described on or before the 12th day of September A. D. 19 50 and for the

application to beneficial use of said water on or before the 12th day of September A. D. 19 53

and, whereas, on the 26th day of November, 1975, the Permit was transferred to Henry C. Hollenbeck

and:

(3) WHEREAS, It is hereby certified that the applicant has complied with the provisions of the laws of the State of South Dakota relating to completion of the construction of the water supply system and is entitled to divert .85 cubic feet per second of water for beneficial use and,

(4) WHEREAS, It is hereby certified that the applicant has complied with the provisions of the laws of the State of South Dakota relating to the application of water to beneficial use of the following extent.

for irrigating 60 acres in the E1/4 NW1/4, Section 17, T6S, R1E



Hydro ID 710

7 of 11

(5) NOW, THEREFORE, By the virtue of the authority vested in us by the laws of the State of South Dakota, We hereby grant and confirm to

Henry C. Hellenbeck

of

Edgemont

the holder and owner of said permit No.

380-2

a water right, dating from

June 29, 1951

to use of _____ cubic feet per second of the waters

.85

of

artesian ground water

in the County of _____ and State of South Dakota, or so much thereof as may be necessary for the

Custer

purposes hereinbelow mentioned, to be diverted at

a point in the center of NW $\frac{1}{4}$, Section 17, T6S, R1E

and conduct to and upon

60 acres in the E $\frac{1}{2}$ NW $\frac{1}{4}$, Section 17, T6S, R1E

for the purpose of

Irrigation

Subject to any limitations listed in Water Right Permit No. **380-2** and subject to the laws of the State of South Dakota.

WITNESS, My hand and seal of our office at Pierre, South Dakota

this **9th** day of **September** A. D.

Nineteen Hundred and

Seventy-seven

WATER RIGHTS COMMISSION

By:

Chief Engineer, Executive Officer

JOHN HATCH



Form 15.

Permit No. 300-2

Water Diversion No. 2 Fall River Water District

CERTIFICATE OF CONSTRUCTION

This is to Certify, That Henry C. Hollenback

the holder of

Permit No. 300-2, issued upon Application No. 300-2, bearing date of priority of June 29,

1931 authorizing the diversion of 1.78 cu. ft per second of the waters of

antelope ground water county of Custer, State of South Dakota at

a point in the center of the NW 1/4, Section 17, T6S, R1E

, for irrigation

purposes, he has complied with the provisions of the laws of the State of South Dakota relating to proof of completion of the works of diversion set out and described in said Permit; that said works are found in satisfactory condition for diverting and conveying to the place of intended use 1.78 cu. ft. per second of water.

Date September 9, 1977

By: **WATER RIGHTS COMMISSION**
John Hatch
JOHN HATCH, Chief Engineer



9--Notice of Intenti to appropriate Water
(First Publication _____, 19__)

Nos. 379-2 & 380-2

APPROPRIATION OF WATER

Office of State Engineer,
Pierre, S. Dak., July 10, 1951

Notice is hereby given that Darrel Hawthorne whose postoffice address is Dewey, South Dakota, has made applications in accordance with the provisions of the water laws of South Dakota for permits to appropriate for beneficial use as follows:
1000 gallons of water per minute of time from ground water supply through the Golden Cliff Irrigation Project, Well No. 1, the point of diversion of which is to be located in the NW $\frac{1}{4}$ of the SW $\frac{1}{4}$ of Section 9, Twp. 6S., Range 1E. 800 gallons of water per minute of time from ground water supply through the Golden Cliff Irrigation Project, Well No. 2, the point of diversion of which is to be located in the NW $\frac{1}{4}$ of the NW $\frac{1}{4}$ of Section 17, Twp. 6S., Range 1E. Said water to be used for the purpose of providing irrigation on the following described land: NW $\frac{1}{4}$ Sec. 17, NE $\frac{1}{2}$ NE $\frac{1}{4}$ Sec. 18, NW $\frac{1}{4}$ Sec. 6, W $\frac{1}{2}$ NE $\frac{1}{4}$ Sec. 6, NW $\frac{1}{4}$ SW $\frac{1}{4}$ Sec 6, E $\frac{1}{2}$ SW $\frac{1}{4}$ Sec. 6, W $\frac{1}{2}$ SE $\frac{1}{4}$ Sec. 6, NE $\frac{1}{4}$ NW $\frac{1}{4}$ Sec. 11, and NW $\frac{1}{4}$ NE $\frac{1}{4}$ Sec. 7. T. 6S., R. 1E.

This application will be taken up by the State Engineer at his office at Pierre for consideration upon the 21st day of August 1951, at 10:00 A.M. All persons who believe that their prior rights would be injuriously affected, or that the allowance of the permit would be detrimental to the public welfare shall file such protest with the State Engineer in writing prior to the above date and may appear on the day above mentioned in person for the purpose of discussing further, the information presented.

Appropriate action will be taken by the State Engineer after suitable time has elapsed for the consideration of any or all information presented.

HCS:mt
Enc.
cc: Richardson

DEAN W. LOECKS
State Engineer



Permit No. 380-2

Water Division 2 Fall River Water District

**REPORT OF EXAMINATION OF WORKS
AND/OR APPLICATION OF WATER TO BENEFICIAL USE**

TO: Water Resources Commission, State Office Building No. 2, Pierre, South Dakota 57501

I have this day made a thorough examination of the water use system constructed by Darrel Hawthorne of Custer, SD holder of Permit No. 380-2, bearing date of priority of June 29, 1951, authorizing the diversion of 1.78 cu. ft. per second of the waters of ground water for irrigation purposes, in Custer County.

I have to report on the condition of the same as follows:

The Water Use System consists of,

A. Works used to divert the water:

376 foot flowing artesian well, steel cased; fill's storage dam, 15 foot high, 30 foot wide at the base and 50 foot in length on the west side and 60 foot in length on the south side.

B. Works used to transport water to place of use,

Approx. 800 feet of natural ditch

C. Works used to apply water to beneficial use.

Flood irrigates by spreading

The system is in the following condition: Fair

The point of diversion is located Center of NW $\frac{1}{4}$, Sec. 17, T6S., R1E., B.H.M.

The works are capable of diverting and conveying to the place of use ~ 1.78

cu. ft. per second of water which is to be used for irrigation

Water has been put to beneficial use to the maximum extent as follows:

E $\frac{1}{2}$ of NW $\frac{1}{4}$ of Sec. 17, T6S., R1E., B.H.M.

comprising a total of 60 acres of land.

Henry C. Hollenbeck
Star Rt.
Edgemont, SD 57735

Date 8-25-75

Thomas A. Gardner
(Signature)

THOMAS A GARDNER
Water Resources Engineer



Form 20.

No. 380-2

NOTICE OF TRANSFER OF WATER PERMIT

TO: **WATER RIGHTS COMMISSION**
State Office Building No. 2
Pierre, South Dakota 57501

Date _____

This is to notify you that title to the lands described as follows:
E 1/4 NW 1/4 of Sec. 17, T6S., R1E., D.H.M.

formerly owned by Darrel Hawthorne

has been transferred to Henry C. Hollenbeck

together with any rights to the beneficial use of water thereon as evidenced by Water Right Permit No. 380-2 as provided for in Section 61.0127 of the 1960 Supplement to the South Dakota Code of 1939.

You are therefore hereby requested to file this "Notice of Transfer of Water Permit" in its appropriate file at the Office of Water Resources, **WATER RIGHTS COMMISSION** evidence of the change of ownership.

A fee of one dollar is hereto attached to cover filing fees as required under Section 61.0159 of the 1960 Supplement to the South Dakota Code of 1939.

STATE OF SOUTH DAKOTA)
County of _____) ss.

Henry C. Hollenbeck being first duly sworn on my oath depose and say: That my relation to the above described undertaking is that of Owner, that I have read the above foregoing statement, and I know of my own personal knowledge that the information herein stated is true.

Henry C. Hollenbeck
(Signed)

Subscribed and sworn to before me this 24th day of Nov, 19 75

Merrill B. Beard
(Notary Public)

This page intentionally left blank

SOURCE R

AN EARLIER NAME FOR HYDRO ID 710

(Letter from R.M. Caywood, Silver King Mines, Inc., to Clinton C. Smythe, Tennessee Valley Authority,
May 12, 1980)

This page intentionally left blank

KEA



Silver King Mines, Inc.

P.O. Box 49
Edgemont, South Dakota 57735

May 12, 1980

Clinton C. Smythe
Project Manager
Edgemont Project
Tennessee Valley Authority
P. O. Box 2957
Casper, Wyoming 82602

RE: CAY; 143,80

Dear Clint:

Attached are water levels and flow rates for Burdock Area water wells measured during the April, 1980 quarterly well check. Please note the addition of Wells #149 and 150.

<u>Well No.</u>	<u>Location*</u>	<u>Well Owner</u>
149	T 6 S, R 1 E, Sec. 17 bb	H. C. Hollenbeck
150	T 6 S, R 1 E, Sec. 6 aa	H. C. Hollenbeck

Very truly yours,

SILVER KING MINES, INC.

R. M. Caywood
Resident Manager

KEA:dlg
Enclosure

cc: David C. Arnold
C. Richard Dodson(encl)
R. J. Mullin "
J. M. Boggs "
R. L. Doty "
J. T. Watson "

QUARTERLY WELL CHECK

April, 1980

Well No.	Date Read	Water Level/gpm	Change Since Last Report	Remarks
136	4-17-80	3.60'	down .10'	
139	4-25-80	23.00 gpm	None	
141	5-1-80	.60 gpm	None	
147	5-1-80	10.90'	Down .75'	
148	5-1-80	flows	Well still flows, but dropped about 8".	MP elevation has been
149	4-29-80	19.20'	first measurement	
150	4-29-80	70.70'	first measurement	
200	4-30-80	52.02'	up 1.00'	
202	4-30-80	16.34'	up .12'	
204	4-28-80	37.12'	down .29'	
205	4-30-80	24.48'	down .37'	
206	4-30-80	18.49'	down .33'	
209	4-30-80	145.75	down 1.11'	
212	4-28-80	2.75 gpm	None	
213	4-28-80	32.97'	down .42'	
214	4-28-80	80.40'	down .40'	
216	4-30-80	220.37	down 1.37'	